

# DSSK20-015A

## 150 V, 2x 10 A Schottky Rectifier Diode

RoHS

Pb

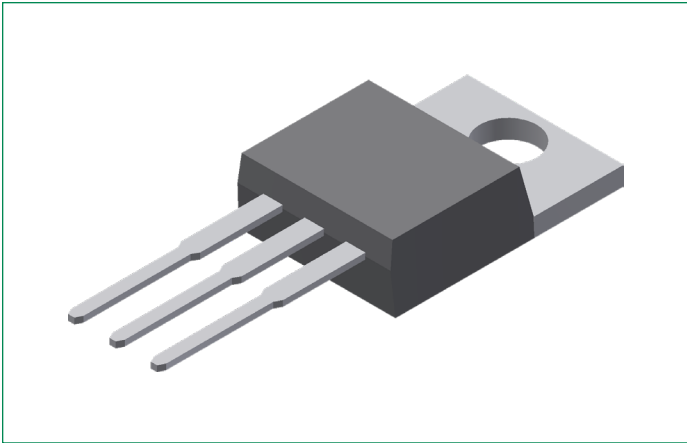

### Description:

- Very low  $V_f$
- Extremely low switching losses
- Low  $I_{rm}$  values
- Improved thermal behavior
- High reliability circuit operation
- Low voltage peaks for reduced protection circuits
- Low noise switching
- Terminals finish: 100% Pure Tin
- This is a Pb – Free Device
- Epoxy meets UL 94V-0

### Pinout Diagram (TO-220AB)

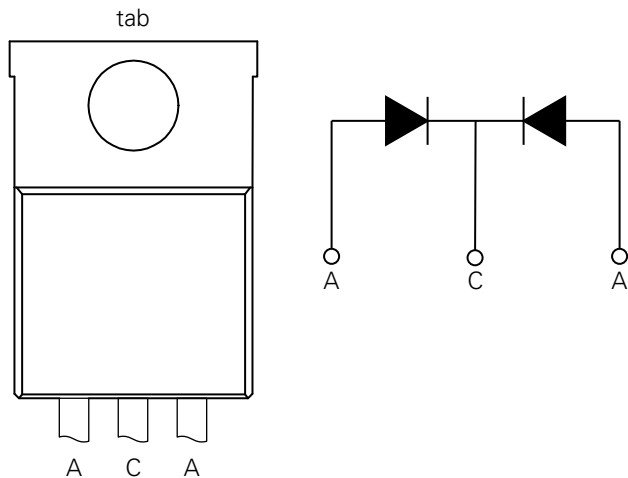

**C:** Cathode; **A:** Anode; **tab:** Cathode

### Applications:

- Rectifiers in switch mode power supplies (SMPS)
- Free wheeling diode in low voltage converters

**Maximum Ratings** ( $T_A = 25^\circ\text{C}$  unless otherwise specified)

Symbol	Characteristics	Condition	Max.	Units
$V_{RRM}$	Peak Repetitive Reverse Voltage	–	150	V
$V_{RWM}$	Working Peak Reverse Voltage			
$V_R$	DC Blocking Voltage			
$I_{F(AV)}$	Average Rectified Forward Current	50% duty cycle @ $T_C = 165^\circ\text{C}$ , rectangular wave form	10 (Per Leg) 20 (Per Device)	A
$I_{FSM}$	Peak One Cycle Non-Repetitive Surge Current (Per Leg)	10 ms, Half Sine pulse, $T_J = 25^\circ\text{C}$	300	A
$P_{tot}$	Total power dissipation	$T_C = 25^\circ\text{C}$	105	W

**Electrical Characteristics** ( $T_A = 25^\circ\text{C}$  unless otherwise specified)

Symbol	Characteristics	Conditions	Typ.	Max.	Units
$V_{F1}$	Forward Voltage Drop (Per Leg) <sup>1</sup>	@ 10A, Pulse, $T_J = 25^\circ\text{C}$	–	0.78	V
$V_{F2}$		@ 10A, Pulse, $T_J = 125^\circ\text{C}$	–	0.65	V
$I_{R1}$	Reverse Current (Per Leg)*	@ $V_R = \text{rated } V_R, T_J = 25^\circ\text{C}$	–	500	$\mu\text{A}$
$I_{R2}$		@ $V_R = \text{rated } V_R, T_J = 125^\circ\text{C}$	–	5	mA
$C_T$	Junction Capacitance	@ $V_R = 24\text{V}, T_C = 25^\circ\text{C}$ $f_{SIG} = 1\text{MHz}$	237	–	pF

**Note 1:** Pulse width < 300  $\mu\text{s}$ , duty cycle < 2%

**Thermal-Mechanical Specifications**

Symbol	Characteristics	Condition	Specification	Units
$T_J$	Junction Temperature	–	-55 to +175	$^\circ\text{C}$
$T_O$	Operation Temperature	–	-55 to +150	$^\circ\text{C}$
$T_{stg}$	Storage Temperature	–	-55 to +150	$^\circ\text{C}$
$M_D$	Mounting torque	–	Min 0.4 Max 0.6	Nm
$F_C$	Mounting force with clip	–	Min 20 Max 60	N
$R_{\theta JC}$	Maximum Thermal Resistance Junction to Case	DC operation	1.4	$^\circ\text{C}/\text{W}$
$R_{\theta CS}$	Typical Thermal Resistance Case to Heat Sink	–	0.5	$^\circ\text{C}/\text{W}$
wt	Approximate Weight	–	2.0	g

### Characteristic Curves

Fig. 1. Typical Forward Characteristics

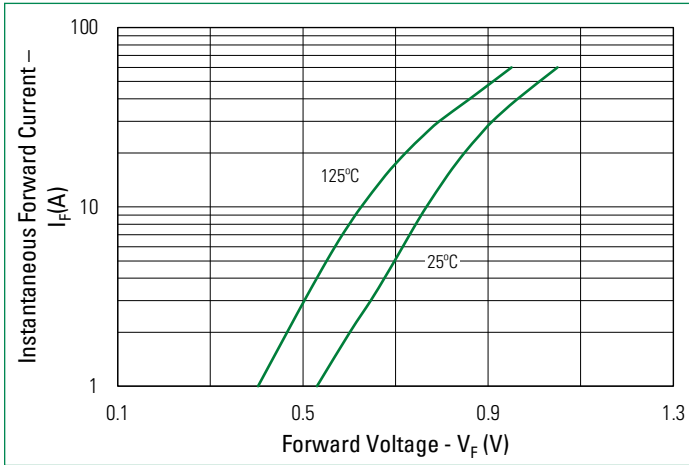

Fig. 2. Typical Reverse Characteristics

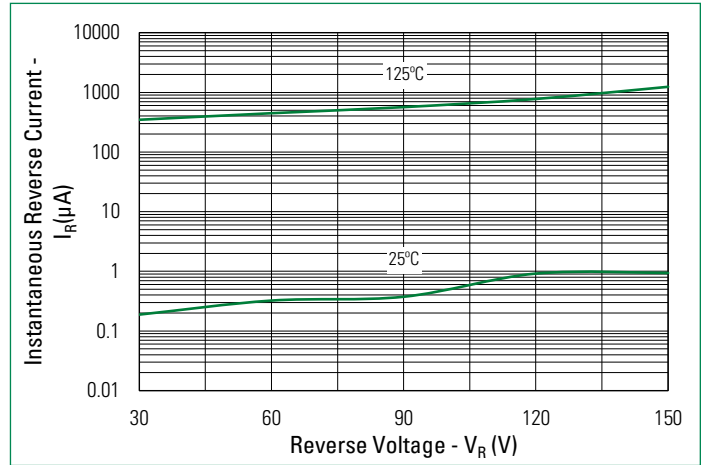
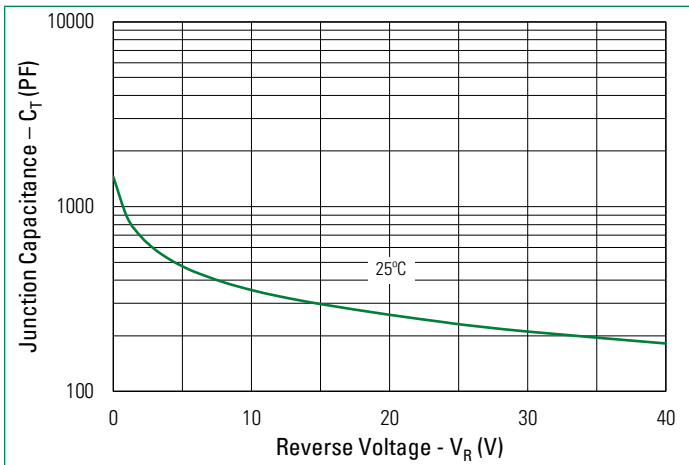
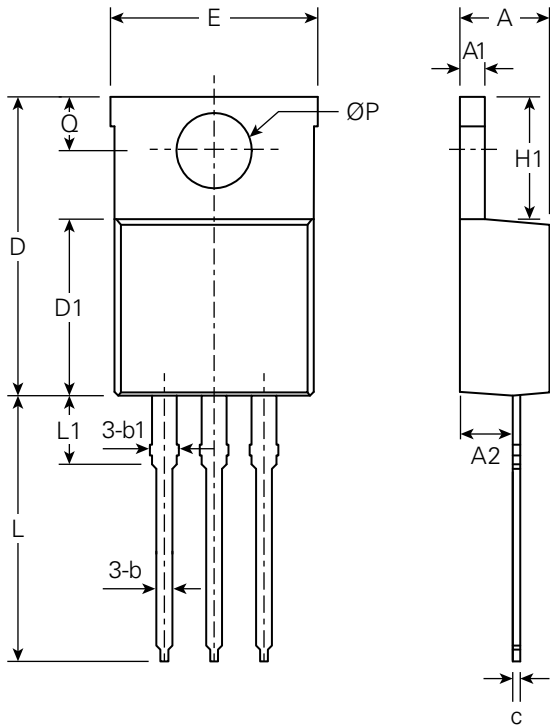

Fig. 3. Typical Junction Capacitance



Part Outline Drawing (TO-220AB)



Symbol	Inches			Millimeters		
	Min.	Typical	Max.	Min.	Typical	Max.
A	0.14	-	0.19	3.56	-	4.83
A1	0.02	-	0.06	0.51	-	1.40
A2	0.08	-	0.11	2.03	-	2.92
b	0.01	-	0.04	0.38	-	1.02
b1	0.44	-	0.07	1.14	-	1.78
c	0.01	-	0.02	0.31	-	0.61
D	0.56	-	0.65	14.22	-	16.51
D1	0.33	-	0.37	8.38	-	9.42
E	0.38	-	0.42	9.65	-	10.67
e	-	0.1	-	-	2.54	-
e1	-	0.20	-	-	5.08	-
H1	0.23	-	0.27	5.84	-	6.86
L	0.50	-	0.58	12.70	-	14.73
L1	-	-	0.25	-	-	6.35
ØP	-	0.14	-	-	3.56	-
Q	0.10	-	0.14	2.54	-	3.43

Part Number and Marking

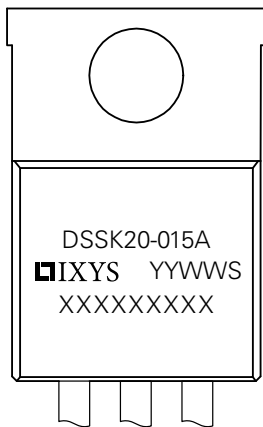

- DS = Schottky Diode
- SK = Product Generation
- 20 = Current Rate
- 015 = Voltage Rating
- A = Package Code
- YY = Year
- WW = Work Week
- S = Plant Location Code
- XXXXXXXXXX = Lot Number

Ordering Information

Part Number	Marking	Packing Mode	M.O.Q
DSSK20-015A	DSSK20-015A	Tube (50 pcs)	-

Packing Specifications

