



# FRED

$V_{RRM} = 600\text{ V}$   
 $I_{FAV} = 2 \times 30\text{ A}$   
 $t_{rr} = 35\text{ ns}$

## Fast Recovery Epitaxial Diode Common Cathode

**Part number**

**DSEK60-06A**

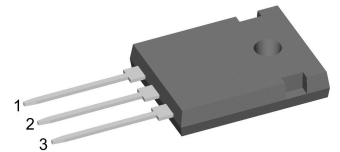

Backside: cathode

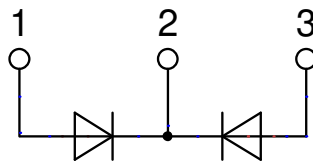

**Features / Advantages:**

- Planar passivated chips
- Low leakage current
- Very short recovery time
- Improved thermal behaviour
- Very low  $I_{rm}$ -values
- Very soft recovery behaviour
- Avalanche voltage rated for reliable operation
- Soft reverse recovery for low EMI/RFI
- Low  $I_{rm}$  reduces:
  - Power dissipation within the diode
  - Turn-on loss in the commutating switch

**Applications:**

- Antiparallel diode for high frequency switching devices
- Antisaturation diode
- Snubber diode
- Free wheeling diode
- Rectifiers in switch mode power supplies (SMPS)
- Uninterruptible power supplies (UPS)

**Package: TO-247**

- Industry standard outline
- RoHS compliant
- Epoxy meets UL 94V-0

**Disclaimer Notice**

Information furnished is believed to be accurate and reliable. However, users should independently evaluate the suitability of and test each product selected for their own applications. Littelfuse products are not designed for, and may not be used in, all applications. Read complete Disclaimer Notice at [www.littelfuse.com/disclaimer-electronics](http://www.littelfuse.com/disclaimer-electronics).



Fast Diode				Ratings			
Symbol	Definition	Conditions	min.	typ.	max.	Unit	
$V_{RSM}$	max. non-repetitive reverse blocking voltage	$T_{VJ} = 25^{\circ}C$			600	V	
$V_{RRM}$	max. repetitive reverse blocking voltage	$T_{VJ} = 25^{\circ}C$			600	V	
$I_R$	reverse current, drain current	$V_R = 600 V$	$T_{VJ} = 25^{\circ}C$		100	$\mu A$	
		$V_R = 480 V$	$T_{VJ} = 125^{\circ}C$		7	mA	
$V_F$	forward voltage drop	$I_F = 37 A$	$T_{VJ} = 25^{\circ}C$		1.52	V	
		$I_F = 74 A$			1.71	V	
		$I_F = 37 A$	$T_{VJ} = 150^{\circ}C$		1.36	V	
		$I_F = 74 A$			1.64	V	
$I_{FAV}$	average forward current	$T_C = 110^{\circ}C$ rectangular $d = 0.5$	$T_{VJ} = 150^{\circ}C$		30	A	
$V_{FO}$	threshold voltage	} for power loss calculation only	$T_{VJ} = 150^{\circ}C$		1.10	V	
$r_F$	slope resistance				8.5	m $\Omega$	
$R_{thJC}$	thermal resistance junction to case				0.8	K/W	
$R_{thCH}$	thermal resistance case to heatsink			0.25		K/W	
$P_{tot}$	total power dissipation		$T_C = 25^{\circ}C$		155	W	
$I_{FSM}$	max. forward surge current	$t = 10 ms; (50 Hz), sine; V_R = 0 V$	$T_{VJ} = 45^{\circ}C$		300	A	
$C_J$	junction capacitance	$V_R = 600 V f = 1 MHz$	$T_{VJ} = 25^{\circ}C$		22	pF	
$I_{RM}$	max. reverse recovery current	} $I_F = 37 A; V_R = 350 V$ $-di_F/dt = 200 A/\mu s$	$T_{VJ} = 25^{\circ}C$		5.5	A	
			$T_{VJ} = 100^{\circ}C$		9	A	
$t_{rr}$	reverse recovery time		$T_{VJ} = 25^{\circ}C$		80	ns	
			$T_{VJ} = 100^{\circ}C$		150	ns	



Package TO-247			Ratings			
Symbol	Definition	Conditions	min.	typ.	max.	Unit
$I_{RMS}$	RMS current	per terminal <sup>1)</sup>			70	A
$T_{VJ}$	virtual junction temperature		-40		150	°C
$T_{op}$	operation temperature		-40		125	°C
$T_{stg}$	storage temperature		-40		150	°C
<b>Weight</b>				6		g
$M_D$	mounting torque		0.8		1.2	Nm
$F_C$	mounting force with clip		20		120	N

**Product Marking**

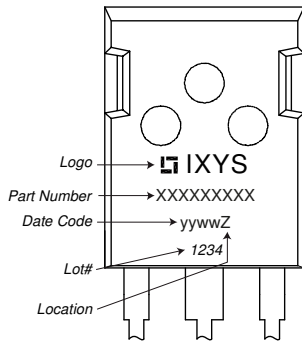

Ordering	Ordering Number	Marking on Product	Delivery Mode	Quantity	Code No.
Standard	DSEK60-06A	DSEK60-06A	Tube	30	471534

**Equivalent Circuits for Simulation**

*\* on die level*

$T_{VJ} = 150^{\circ}C$

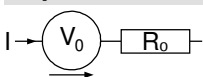

**Fast Diode**

$V_{0\ max}$	threshold voltage	1.1	V
$R_{0\ max}$	slope resistance *	6	mΩ



**Outlines TO-247**

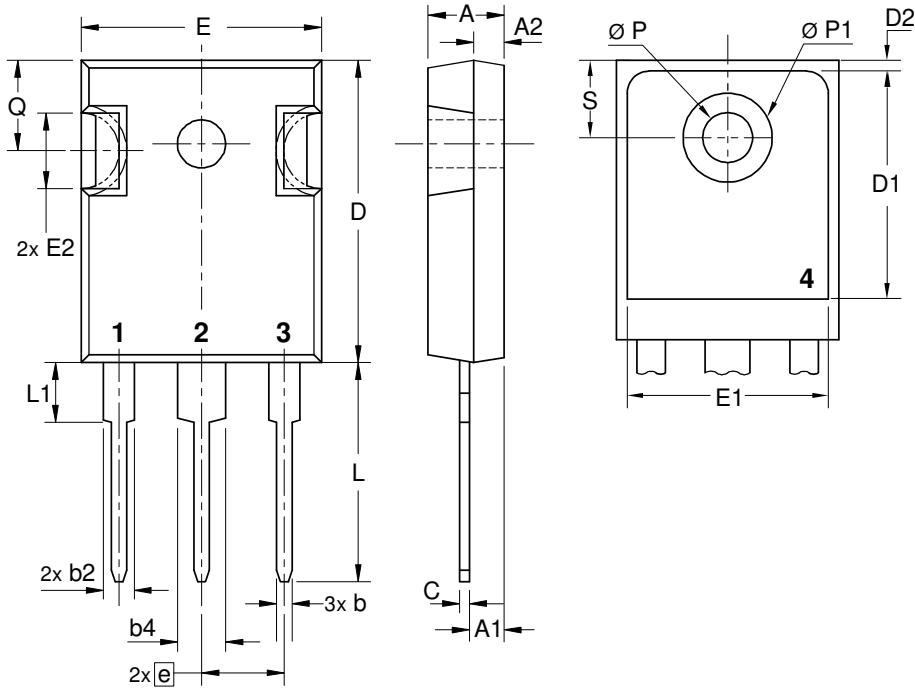

Sym.	Inches		Millimeter	
	min.	max.	min.	max.
A	0.185	0.209	4.70	5.30
A1	0.087	0.102	2.21	2.59
A2	0.059	0.098	1.50	2.49
D	0.819	0.845	20.79	21.45
E	0.610	0.640	15.48	16.24
E2	0.170	0.216	4.31	5.48
e	0.215 BSC		5.46 BSC	
L	0.780	0.800	19.80	20.30
L1	-	0.177	-	4.49
Ø P	0.140	0.144	3.55	3.65
Q	0.212		5.38	
S	0.242 BSC		6.14 BSC	
b	0.039	0.055	0.99	1.40
b2	0.065	0.094	1.65	2.39
b4	0.102	0.135	2.59	3.43
c	0.015	0.035	0.38	0.89
D1	0.515	-	13.07	-
D2	0.020	0.053	0.51	1.35
E1	0.530	-	13.45	-
Ø P1	-	0.29	-	7.39

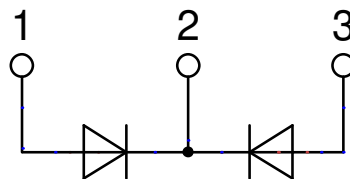



**Fast Diode**

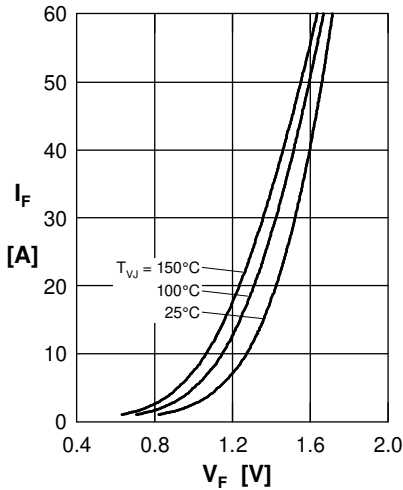

Fig. 1 Forward current  $I_F$  versus max. forward voltage drop  $V_F$

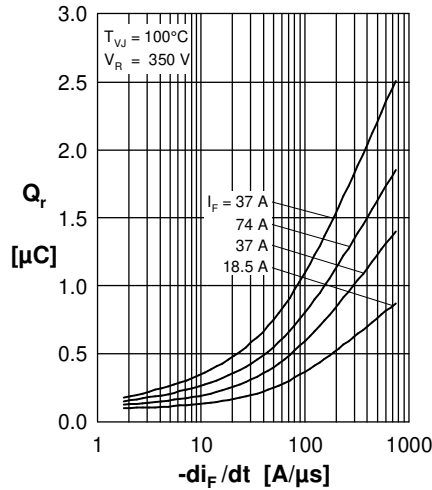

Fig. 2 Typ. reverse recov. charge  $Q_r$  versus  $-di_F/dt$

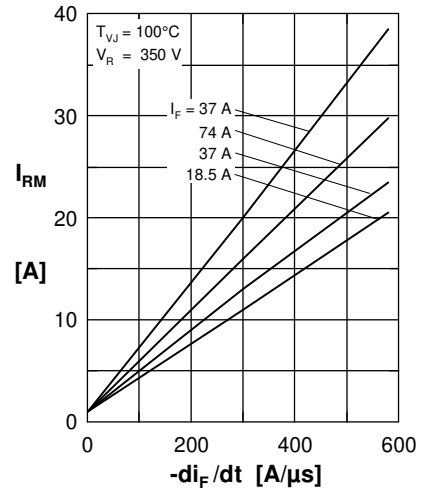

Fig. 3 Typ. peak reverse current  $I_{RM}$  versus  $-di_F/dt$

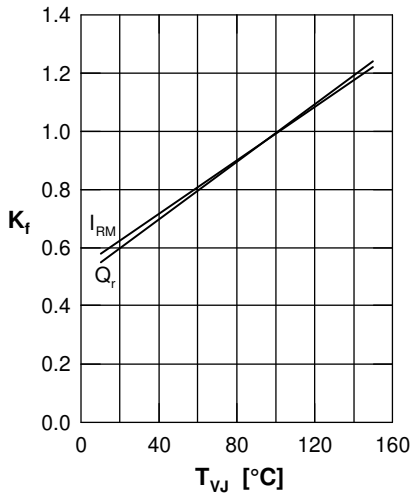

Fig. 4 Dynamic parameters  $Q_r$ ,  $I_{RM}$  versus  $T_{VJ}$

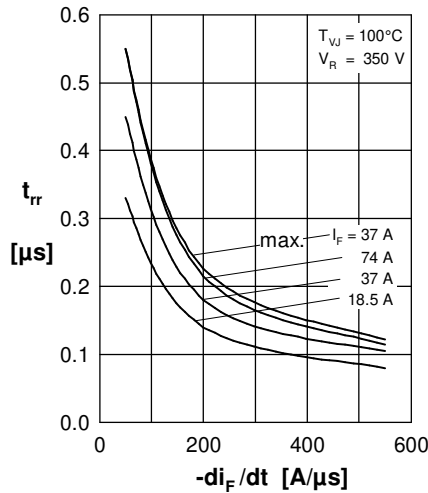

Fig. 5 Typ. recovery time  $t_{rr}$  versus  $-di_F/dt$

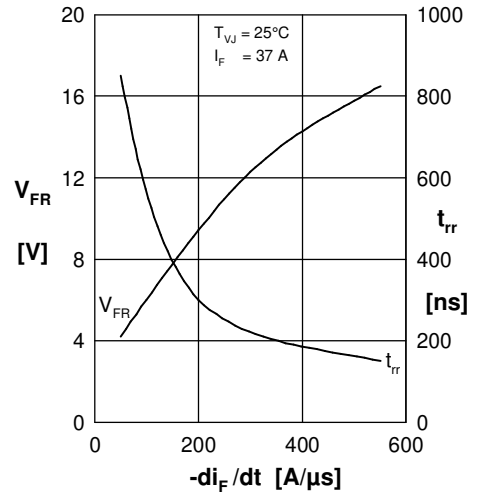

Fig. 6 Typ. peak forward voltage  $V_{FR}$  and  $t_{rr}$  versus  $di_F/dt$

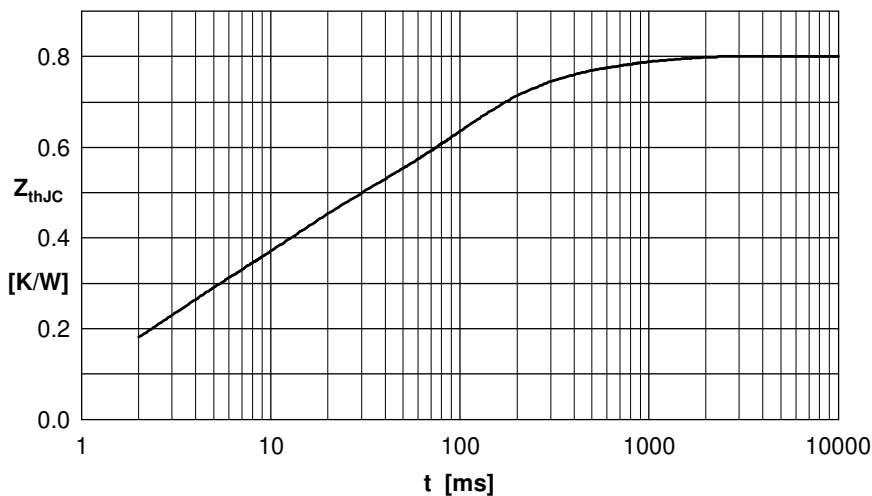

Fig. 7 Transient thermal impedance junction to case

Constants for  $Z_{thJC}$  calculation:

i	$R_{thi}$ (K/W)	$t_i$ (s)
1	0.200	0.0018
2	0.220	0.0100
3	0.080	0.5000
4	0.300	0.0900