

MM	IN
1.58	0.062
7.13	0.281
25.40	1.000
37.28	1.467
62.68	2.467
84.78	3.338
101.60	4.000
115.08	4.531
122.22	4.812
152.40	6.000
1828.80	72.000
1.0 mm ²	16 ga

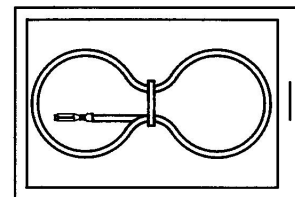
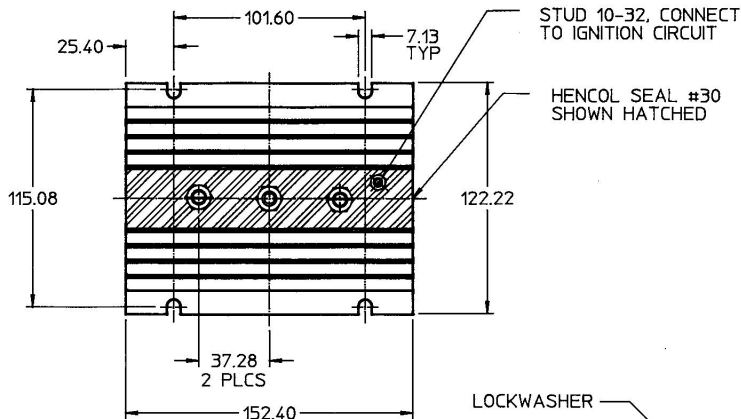

BAGGED PARTS

SCALE 1:2
NOTE 3

SHIPPED LOOSE

LOCKWASHER, 3 REQD

HEX NUT, 5 REQD

STUD, 5/16-18, 3 PL

LOCKWASHER

HEX NUT, 10-32, 2 REQD

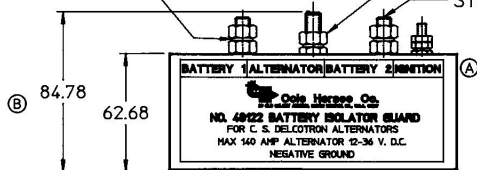

HEATSINK, BLUE

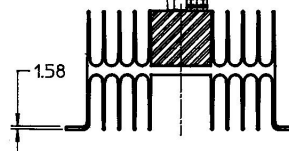

NOTES:

1. ALL STEEL PARTS PLATED
2. ALL DIM'S REFERENCE ONLY
3. BAGGED PARTS INCLUDE 1-WIRE LEAD, 1.0 mm² GPT YELLOW, 1828.80 LONG WITH PACKARD TERMINAL #12015824 ATTACHED AND INFORMATION SHEET.

Confidential Property of Cole Hersee

METRIC

DO NOT SCALE

LET.	WAS	DATE	BY	LET.	WAS	DATE	BY	MATERIAL	DRWN	CHK	APVD	SCALE	EX22439	EX22627	DATE DRAWN
												1:2			10/5/88
				B	87.48	12/29/93	BL	FINISH							DATE BLUEPRINTED
				A	ECN 24012	7/22/89	JP	TOLERANCES DECIMAL & ANGLE &							
					ISSUED	2/2/89	AF								

Cole Hersee Co.
20 OLD COLONY AVENUE, BOSTON, MA, U.S.A., 02127
BATTERY ISOLATOR GUARD
FOR C S DELTRON ALTERNATOR