

AAA 124
 25 010
 96 038
 182 072
 965 380
 1435 565
 1752 690
 1981 780

55089

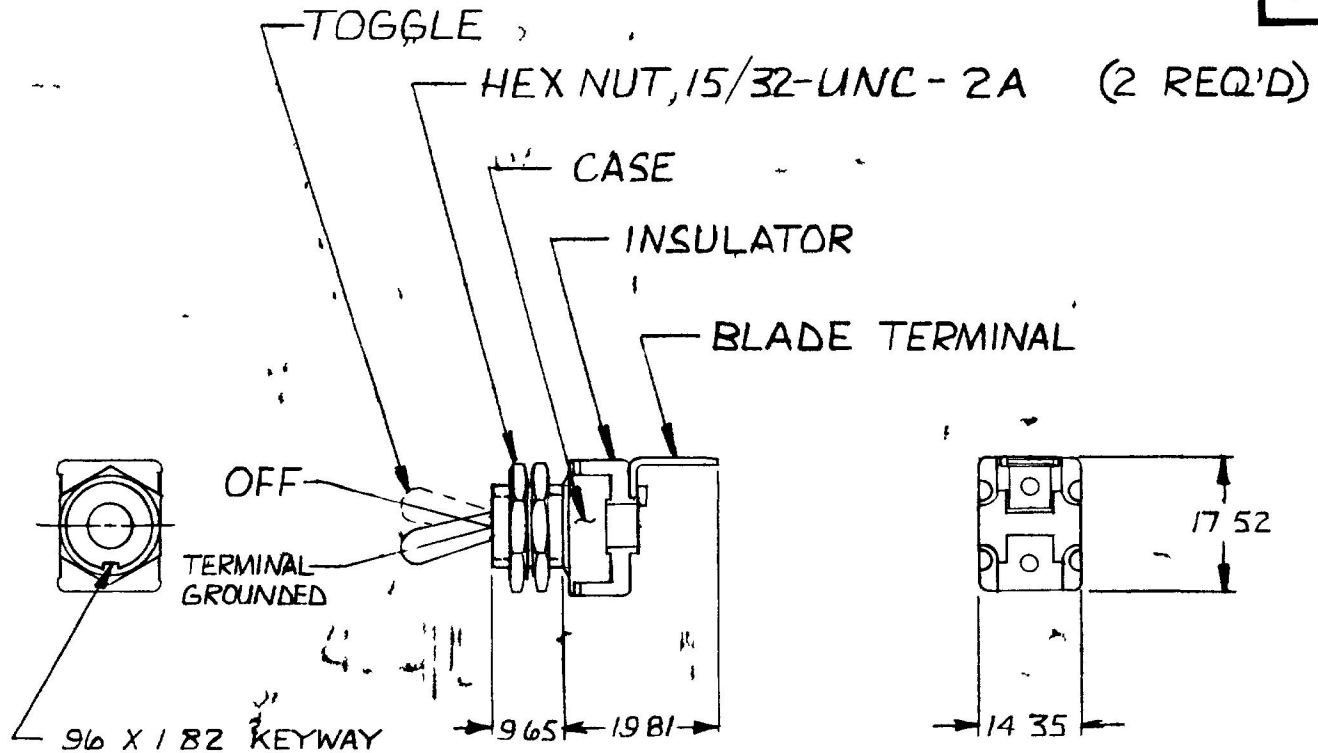

EX19154

NOTE

1 ALL STEEL PARTS PLATED

METRIC

DO NOT SCALE

LET	WAS	DATE	BY	LET	WAS	DATE	BY	MATERIAL	DRAWN	CHECKED	APPR'D	SCALE	DATE DRAWN
								—H—	(R)	R7		1:1	11-19-80
								FINISH	 COLE HERSEE CO. 200 OLSON HWY SOUTH BEND, IN 46708				DATE BLUEPRINT
								—H—					
								TOLERANCES	SP-ST TOGGLE SWITCH				55089
								DECIMAL ±					
								METRIC ± 25					
					ISSUED	1-13-81	RJ						

CH 188(4 78)