

5586

20

COLE-HERSEE CO

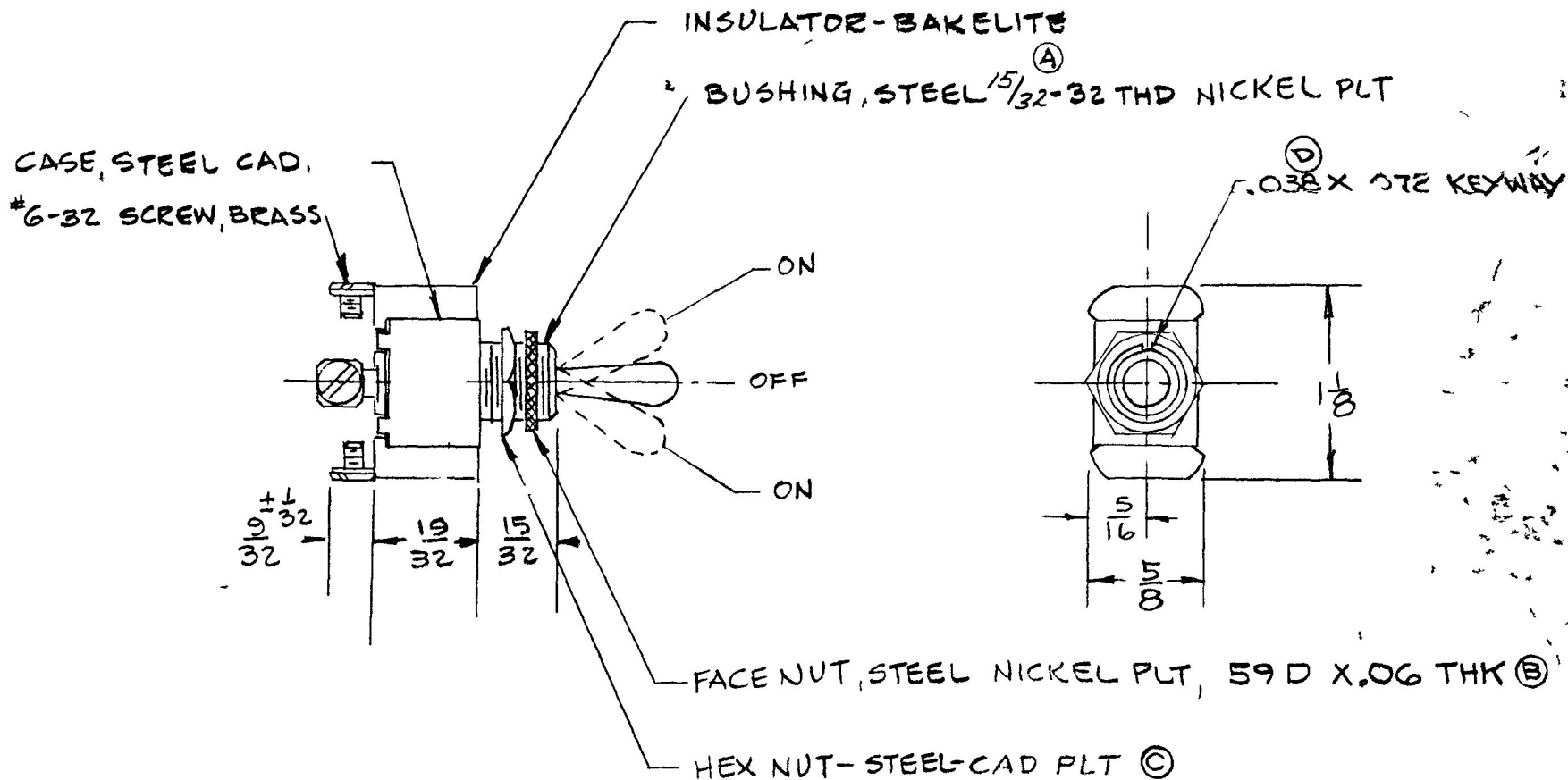

© NOTE
SILVER CONTACT SURFACES

LET	WAS	DATE	BY	LET	WAS	DATE	BY	MATERIAL	DRAWN	CHECKED	A	PRV	D	SCALE	USED ON	DATE DRAWN
				E	ADD NOTE	2543a	9/15/93	JH		GFC				1"=1"		2-3-54
				D	03X 06 KEYWAY	17537	1-4-72	H	FINISH		COLE-HERSEE COMPANY BOSTON 27 MASS U S A					DATE ISSUED
				C	NICKEL PLT	16299	11-22-68	B								(N/A)
				B	ADDED DIM	16093	5-29-68	W	TOLERANCES FRACTIONAL ± DECIMAL ±		NAME SINGLE POLE, DOUBLE THROW TOGGLE SWITCH					PART NO
				A	7/16-32		10-29-57	P								5586