

92107-03

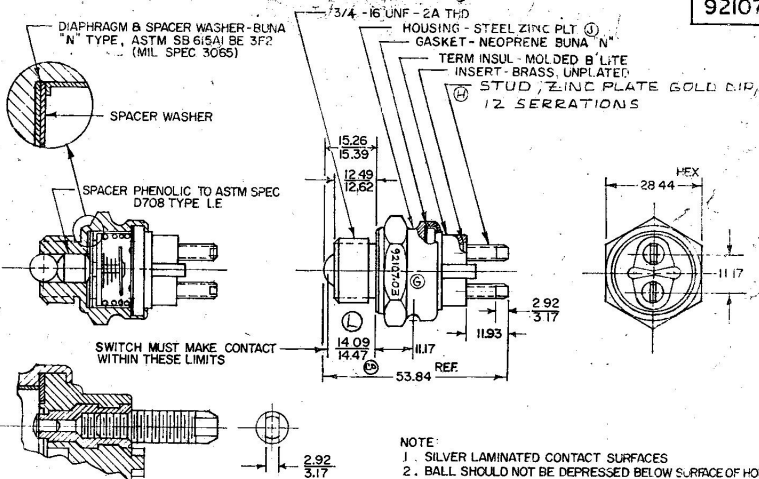

NOTE:

1. SILVER LAMINATED CONTACT SURFACES
2. BALL SHOULD NOT BE DEPRESSED BELOW SURFACE OF HOUSING
3. SWITCH HOUSING SHALL BE CODE DATED AS TO WEEK & YEAR OF SWITCH MANUFACTURE
4. INTERMITTENT CURRENT CARRYING CAPACITY 20AMP MIN 12V
5. INSTALLATION TORQUE 40 FT LBS MAX

METRIC

Confidential Property of Cole Hersee

DO NOT SCALE

LET	WAS	DATE	BY	LET	WAS	DATE	BY	MATERIAL	DRAWN	CHECKED	APPROVD.	SCALE	BASIC, W/23048 SERR & OMIT MTO. GASKET	DATE DRAWN
				K	ADDED SIGNIF CHART SYSTEM	5/11/94	BL		CF	✓	9-25-78	1:1		11-7-67
				J	CHG 22934	1-15-86	CS	FINISH						
				H	REV. 121783	2-2-82								
				G	WORK STAMP 92107-01/215165	12-1-91								
				F	REDRAWN	8-4-78	R	TOLERANCES FRACTIONAL ± DECIMAL ± .25						
L	01635	10/26/64												

SAFETY STARTING SW.

92107-03