



Expertise Applied | Answers Delivered

A background image showing a worker in a hard hat and safety gear amidst a massive, bright orange and yellow arc flash. The scene is filled with sparks and intense light, illustrating the hazardous environment these relays are designed to protect against.

PGR-8800,
AF0500 & AF0100
ARC-FLASH RELAY
TECHNICAL FAQ

FAQ

TABLE OF CONTENTS

General Arc-Flash, PGR-8800, AF0500 and AF0100 Information

How much energy is in a typical arc-flash incident?	4
What is the electrical symbol of an arc-flash relay?	4
How long has Littelfuse had an arc-flash relay in service?.....	4
Do you have a list of references of companies using the Littelfuse Arc-Flash Relays?	4
Do you have an example of Littelfuse Arc-Flash Relays protecting a facility in the event of an arc-flash?.....	4
What are the key considerations when choosing an arc-flash relay?	4
Do the Littelfuse Arc-Flash Relays nuisance trip?	5
Does thermal imaging trip the Littelfuse Arc-Flash Relays?.....	5
Would a camera-flash trigger any of the Littelfuse Arc-Flash Relays?.....	5
Do the Littelfuse Arc-Flash Relays detect ultra-violet light?	5
Do the Littelfuse Arc-Flash Relays provide zone identification?.....	5
Can you compare a service-mode instantaneous setting to an arc-flash relay?	5
Do the different modes of the arc-flash relays have different response times?.....	6
What is the life of the Littelfuse Arc-Flash Relays? What maintenance is required and how often?	6
Does the built in software consider the mechanical delay of all devices in the circuit and allow for changes to faster reacting main breakers?.....	6
How do arc-flash relays compare to Zone Selective Interlocking Protection (ZSIP) and Bus Differential?.....	6

Electrical Design Software

What is SKM software and where can I find more information?	6
How do you enter resistance-grounding or arc-flash relays into the SKM software for calculating arc flash?.....	6
How do you model your optical devices in SKM and ETAP, since the relay is detecting light?	6
How does power system analysis software, such as SKM, EasyPower, and ETAP, recognize arc-flash relays?	7

Applications and Installations

What are the typical applications / system voltages?	8
What is the maximum recommended length from the PGR-8800 or AF0500 to the breaker?	8
Can the PGR-8800 or AF0500 be used in low-voltage systems? Will a low-voltage breaker's closing or opening cause a trip?	8
Is internal arc classification of switchgear enclosures enough to eliminate an arc hazard?	8
When working on an energized transformer, we use instantaneous settings at the feeder breaker relay. Can the arc-flash relay bring any benefit?.....	8
Is there a specific relay to protect all of a switchgear bus section against arc flash?	8
Are there control systems available that truly eliminate or control arc flash?	8

Light Sensors and Current Transformers

What are the installation guidelines for the sensors?	9
What is a typical light sensitivity radius for a fiber optic sensor?	10
Is there a maintenance schedule for the sensors?	10
At what intensity of light will the Littelfuse Arc-Flash Relays indicate or trip?.....	10
How would the fiber-optic sensors be installed in switchgear that is shipped in groups? Do these sensors come in various lengths or with repeaters?	10
How do you test the sensors, are they fail-safe?	11
What is the purpose of the Current Transformers (CTs) and are they required?.....	11

Resistance Grounding

Would a ground fault on the main switchgear act as an arc-flash relay?	11
Can we have more than 5A L-G fault available in HRG in any circumstances?.....	11
Is there protection (resistance grounding) for delta circuits?.....	11
The code only allows HRG if you didn't have neutral to ground loads (i.e. 277 V). Would this only be applied on 3-wire systems?.....	11
How do you address the system-leakage capacitance on HRGs, especially at medium-voltage levels?.....	11
Is it possible to apply HRG to a distribution transformer in order to minimize the arc-flash hazard when working on the secondary of the transformer?.....	12
If you have a neutral-grounding resistor, is an arc-flash relay also recommended?	12

Safety Regulations

Do arc-flash relays lower Personal Protective Equipment (PPE) required?	12
Can arc-flash relays eliminate the need for PPE category 3 or 4 clothing?.....	12
Can arc-flash relays reduce PPE required if only walking in front of the equipment, or opening the cabinet to read a nameplate?	12
What are the regulatory agencies' opinion on arc-flash relays on life safety and critical circuits?	12
When designing a safety protocol, should low-fault current/long clearing-time hazard and a high-fault current/short clearing-time hazard with the same incident energy be treated differently?	12
Is there a recommendation as to how often you need to update the arc-flash label?	13
Our facility completed an arc-flash hazard assessment and have dangerous level categories. Will the Littelfuse Arc-Flash Relays reduce those levels and will that change the amount of PPE required?.....	13
If using this arc-flash relay as the only method to protect personnel from arc flash, should the arc-flash relay be tested and have a Safety Integrity Level (SIL)?	13

Catalog Pages

PGR-8800 Arc-Flash Relay Catalog Page (Datasheet)	14
AF0500 Arc-Flash Relay Catalog Page (Datasheet).....	16
AF0100 Arc-Flash Relay Catalog Page (Datasheet)	18
Arc-Flash Relay Comparison Guide	19



General Arc-Flash Questions

How much energy is in a typical arc-flash incident?

A phase-to-phase fault on a 480-V system with 20,000 amperes of fault current provides 9,600,000 watts of power. Imagine that there is no arc protection and the fault lasts for 200 milliseconds before the overcurrent protection clears it. The released energy would be 2 MJ, which corresponds roughly to a stick of dynamite.

The energy formula is as follows:

$$\text{Energy} = \text{voltage} \times \text{current} \times \text{time} = 480 \text{ V} \times 20,000 \text{ A} \times 0.2 \text{ s} = 1,920,000 \text{ J}$$

For a given system voltage, two factors can be adjusted to reduce arc-flash energy: time and current

Time can be reduced by using a device such as the PGR-8800 or AF0500 to rapidly detect an arc flash, thus cause the connected circuit breaker to trip at its instantaneous speed, overriding any inverse-time delay. Current can be reduced by using current-limiting fuses or, in case of phase-to-ground faults, by using high-resistance grounding.

What is the electrical symbol of an arc-flash relay?

Although there is no formal symbol, Littelfuse is currently using the following:

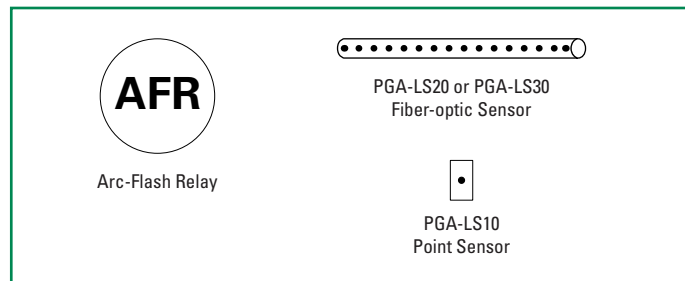

How long has Littelfuse had an arc-flash relay in service?

Littelfuse acquired arc-flash technology from Selco, which had been manufacturing arc-flash relays for almost 20 years. The product was launched in North America in August of 2011. Littelfuse has numerous installations throughout the world and an estimated 18,000 arc-flash relays are installed world-wide.

Do you have a list of references of companies using the Littelfuse Arc-Flash Relays?

Yes, please contact your Littelfuse Sales Rep for a list of available references.

Do you have an example of a Littelfuse Arc-Flash Relay protecting a facility in the event of an arc flash?

Please view our arc-flash case study at Littelfuse.com/ArcFlash for an installation success story where the PGR-8800 saved a plant from catastrophic damage.

What are the key considerations when choosing an arc-flash relay?

We have written a white paper on considerations for choosing an arc-flash relay that examines advantages and drawbacks. It is available to download on our website at Littelfuse.com/ArcFlash.

Is nuisance tripping a problem?

Normal in-house lighting will not cause the arc-flash relays to trip. Flashlights, direct sunlight or strong, focused light at short distances may produce enough light to cause tripping.

If there are concerns about that, the best way to avoid nuisance tripping is by using the optical sensors in conjunction with current supervision. This function is available with PGR-8800. In this scenario, the relay looks at the optical sensors for a fault and if there is a high amount of light, then looks at the CT inputs to see if the current is above the nominal setting you configured, and if both conditions are true, then it will trip the relay. This prevents tripping in cases where there is significant light from an outside source (such as a welder, camera flash or direct sunlight).

Does thermal imaging trip the Littelfuse Arc-Flash Relays?

Assuming the thermal imaging device is passively detecting heat in the switchgear by using the infrared light emitted, there will be no interference with the arc-flash relay or sensors.

Would a camera-flash trigger the Littelfuse Arc-Flash Relays?

When the PGR-8800, AF0500 or AF0100 is set to maximum sensitivity and the amount of time light is required to be present on the sensor is set to a minimum, it is possible that a small point-and-shoot camera close to the sensor could be sufficient to trip the relay. Typically, a compact camera's flash does not present enough intensity to cause a trip, except at VERY close proximity to the sensor. More advanced cameras and larger flashes can trip the Littelfuse Arc-Flash Relays from a greater distance. In applications where this is a concern, it is recommended to use the PGR-8800 with optional CTs so that non-arc-flash light with no corresponding increase in current above normal operating conditions does not cause a trip. Where current supervision is used, both high current and intense light are required to have an arc-flash trip. The PGR-8800 relay can also be toggled into service mode to disable the trip-coil while a camera flash is used. It is imperative to restore the relay to normal operation once the flash photography is completed.

Do the Littelfuse Arc-Flash Relays relay detect ultra-violet light?

The typical spectrum of light from an arc-flash is spread across the visible spectrum and so this is what the PGR-8800, AF0500 and AF0100 relays are detecting. Ultraviolet light is mostly used to detect corona which can be present before an arc flash but is also present in higher voltage systems where no arc flash is imminent. Using ultraviolet light alone could lead to nuisance trips and the relay would only be looking at a small section of the total light from the arc. The point sensor has been designed to work with a wide spectrum of visible light. This is due to the fact that there are no distinct peaks in the spectrum of an arc; the peak depends on the material involved. An arc will typically peak on the visible spectrum and fade out toward the infrared area. Below is a graph depicting the PGA-LS10's spectral sensitivity. The fiber sensor spectral sensitivity is nearly identical. The only difference is the lower part of the spectrum, below ~400 nm, will be cut off.

Do the Littelfuse Arc-Flash Relays provide fault location identification?

Yes, each sensor has an on-board LED as well as a sensor LED on the arc flash relay that provides feedback identifying which sensor caused the trip.

Do the Littelfuse Arc-Flash Relays provide zone tripping?

AF0500 has two high speed IGBT outputs for tripping of circuit breakers. Each sensor input can be assigned individually to any or both of the trip outputs. Thus AF0500 can trip up to 2 independent zones.

Can you compare a service-mode instantaneous setting to an arc-flash relay?

You would need to look at an actual application to do a true comparison. There are cases when lowering the instantaneous setting would serve the same benefit as the arc-flash relay in lowering incident energy. There may be some added complexity to making sure the maintenance mode is entered and also set back to operational mode. You do not want to have mis-coordination or tripping during starting of a motor if you start to exceed the instantaneous level. That being said our motor and feeder relays do have this mode of operation so they are useful. There are cases where the bus may be very large and not loaded (during commissioning for example). An arcing fault is high resistance and may not get near the instantaneous operating range of the breaker. That would be the worst case scenario for the instantaneous setting and show the most difference between it and the light detection method.

Do the different modes of the arc-flash relay have different response times?

It is possible for the arc-flash relay to send a trip signal within 1 ms of detecting light above the threshold settings or within 1 ms of detecting light AND current. It is also possible to configure the relay to have additional delay as needed.

What is the life of the Littelfuse Arc-Flash Relays? What maintenance is required and how often?

The PGR-8800, AF0500 and AF0100 relays have a 5 year warranty but depending on the environment it will last much longer than that. Maintenance required will depend on your application and principally focuses on removing dust collection on light sensors. We recommend checking the light sensors periodically (with a period relevant for the amount of dust) with an external light source to verify that the sensors are not obscured by dust build-up and using compressed air to blow dust off the sensors during regularly scheduled maintenance. It is good practice to periodically check that the IGBT trip output is tripping the breaker. Breaker maintenance is also critical to provide reliable and fast clearing time.

Does the built-in software consider the mechanical delay of all devices in the circuit and allow for changes to faster reacting main breakers?

In reference to the coordination programs such as EDSA, ETAP and SKM. They all allow specific information to be entered on the circuit interrupter chosen in their extensive libraries. This can show changes of using faster main breakers fairly easily. Note if the equipment is older Littelfuse recommends testing the actual operating time of the breakers to make sure they are able to interrupt in the time that is allotted.

How do arc-flash relays compare to Zone Selective Interlocking Protection (ZSIP) and Bus Differential?

These are different technologies that detect and quickly clear faults. ZSIP will detect a fault and block an upstream protective device from operating until the local protective device has a chance to clear the fault. If not, the upstream device attempts to clear it. This takes valuable time (100 ms for detection only) and may be difficult to retrofit.

Bus Differential measures the difference of current going into and out of a device, such as switchgear. If the current supplied by the source travels through the switchgear to the load, all is well. If a fault occurs within the switchgear, the current going in does not equal the current going to the load. This detection method is much quicker (33 ms for detection only) and may be more difficult and/or expensive to retrofit, depending on the number of CTs.

Electrical Design Software

What is SKM software and where can I find more information?

SKM Software (www.skm.com) is one brand of power system analysis software that allows users to define the electrical parameters of their system and model its behavior. It is often used for coordination studies and arc-flash hazard analysis. Other software brands are ETAP, Easy Power and EDSA.

How do you enter resistance-grounding or arc-flash relays into the SKM software for calculating arc flash?

Resistance grounding presently shows no advantage in power system modeling software. The analysis of arc-flash energy is based on three-phase faults. High resistance grounding does eliminate the potential hazard from a single phase-to-ground fault. Different sources show 80 to 90% of faults in a plant start as a single phase-to-ground fault. Arc-flash relays can be entered as a definite time trip (at 1 ms for PGR-8800 and AF0500) which is then added to the breaker clearing time. The advantage of arc-flash detection is that the breaker is no longer waiting for coordination of downstream devices. Another method often used to lower incident energy is to switch the relay or breaker settings to maintenance mode or a second setpoint group. These are lower settings with quicker operating times, often ignoring coordination of downstream devices with knowledge that a person is in the area. When the person leaves the area, the settings are returned to normal.

How do you model your optical devices in SKM and ETAP, since the relay is detecting light?

You must add the arc-flash relay trip time to the breaker shunt-trip operating or clearing time. The result will be a vertical line (definite-time) that shows the same response time regardless of the current. This demonstrates the advantage of using light for arc-flash detection.

How does power system analysis software, such as SKM, EasyPower, and ETAP, recognize arc-flash relays?

SKM software list the PGR-8800 relay in the library and other companies are currently adding the relay. The figure below shows the PGR-8800 Arc-Flash relay modeled in SKM:

The PGR-8800 has two (2) settings for overcurrent protection:

- Pickup is adjustable from 10 to 1000% of the secondary CT rating (any CT with a 5A secondary can be used)
- Time delay from 1 ms to 2 seconds

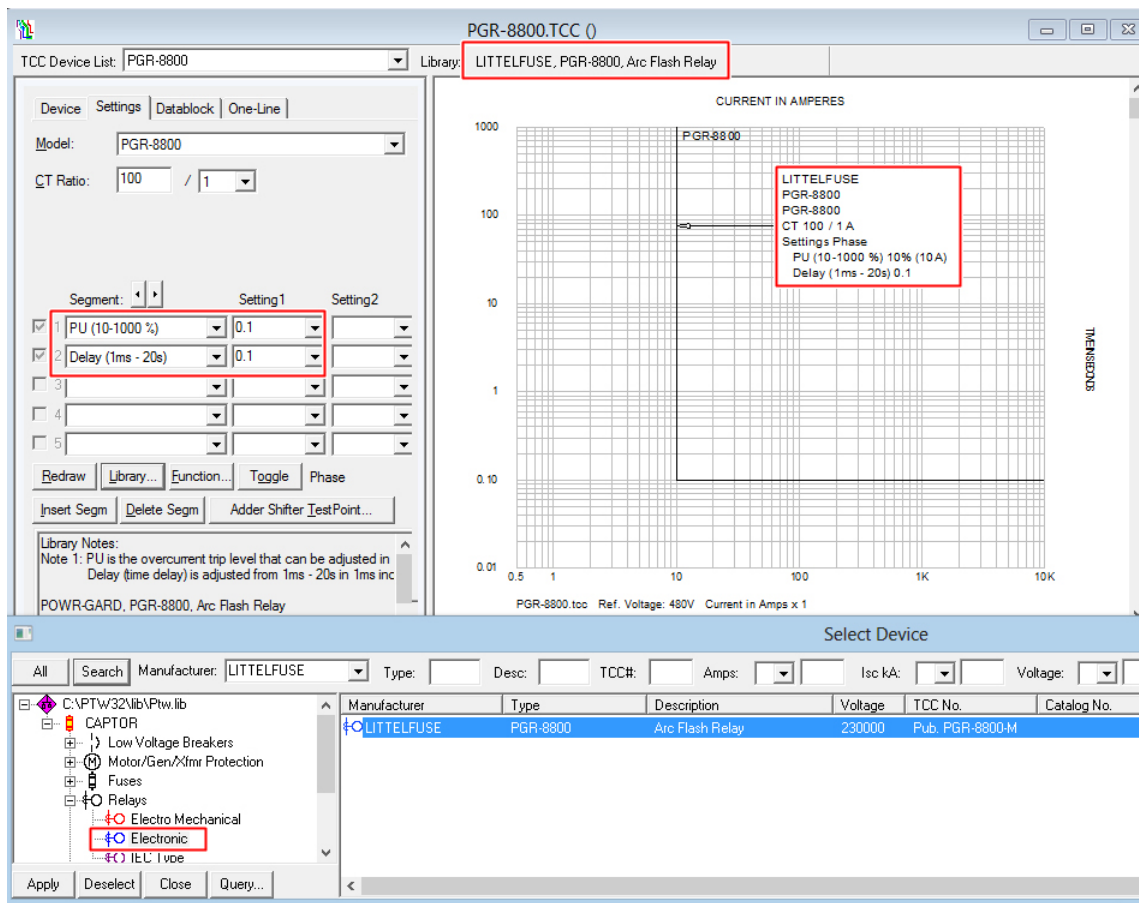

DISCLAIMER: PLEASE VISIT WWW.SKM.COM FOR INSTRUCTIONS ON HOW TO INSTALL THE SKM FILE.

For arc-flash protection, the PGR-8800, AF0500 and AF0100 must see light of sufficient intensity to initiate the tripping sequence. If current inhibit is enabled, the PGR-8800 will not send a trip signal unless there is also sufficient current. Both light and current trip levels can be adjusted.

Currently, no power system analysis software package can model the light detection. They only model the overcurrent setting. To avoid the nuisance tripping with standard overcurrent protection, the user typically increases the pickup value or time delay. This leads to arcing faults going unnoticed until it is too late. With the Littelfuse Arc-Flash Relays, this is not an issue as the light is used to prevent nuisance tripping on electrical noise or momentary overload conditions while still allowing for very fast tripping. Thus, the reaction time is reduced to that of the AF0500 or PGR-8800 (less than 1 ms unless configured otherwise), or AF0100 plus the circuit-breaker operating time, independent of the current.

Bolted Pressure Switches can also be used, but many of these devices have limitations in terms of interrupting and clearing time rating, so the user must check the ratings first. With either a CB or BPS, the opening time or clearing time can be modeled in SKM. The opening time or clearing time must include all devices in the sequence, which includes the shunt trip or undervoltage times as well as circuit breaker times. It is recommended to regularly maintain and test operation of circuit breakers. A qualified testing company could verify and provide the most accurate information on breaker clearing time.

On AF0500 / AF0100 applications and PGR-8800 applications where only light detection is utilized, this clearing time value can be used in the software as a user-defined trip time. For the PGR-8800 applications using current, an alternative is to use the PGR-8800 library model with the current set to a low value to reproduce the current-independent characteristic of optical detection. When current and light are both required then the current-inhibit level setting in the PGR-8800 should be used for the model.

Applications and Installations

What are the typical application / system voltages?

The PGR-8800, AF0500 and AF0100 can be used on electrical systems operating at any voltage (AC or DC) since it does not directly connect to the system. The system is monitored with light sensors and optional current transformers (for AC systems, PGR-8800 only) that can be selected for any current / voltage rating. The small size of these Arc-Flash Relays allows for installation in any switchgear cubicle, transformer compartment, or motor control center bucket.

What is the maximum recommended length from the Littelfuse Arc-Flash Relays to the breaker?

Application specific data is needed to determine the maximum distance of the relay from the circuit breaker. Please refer to the installation manual or call technical support for assistance.

Can the Littelfuse Arc-Flash Relays be used in low-voltage systems and will a low-voltage breaker's closing or opening cause a trip?

When a low-voltage breaker is closing there is often a large inrush current that, depending on the configuration of the PGR-8800, AF0500 or AF0100, could be sufficient to allow a high-intensity light source other than an arc-flash to cause a trip. While low-voltage breakers often produce an arc when they are opening, closing the breaker does not normally produce an arc, so the PGR-8800, AF0500 and AF0100 should not operate unintentionally. When opening the breaker, an arc is typically present as part of normal operation of the breaker. If light sensors are placed such that the breaker arcing is visible then it is recommended to also use current-supervision. The breaker arcing during normal opening will cause a reduction in current because of the increased impedance and if using the PGR-8800, the current-supervision will not operate.

Is internal arc classification of switchgear enclosures enough to eliminate an arc hazard?

No, although it reduces the hazard. The arc-flash relay may help prevent damage to the equipment and provide additional protection in the event that the doors are not properly closed. Depending on the impedance of the arc fault, the arc may persist for a long time in the switchgear and could exceed the rating of the gear.

When working on an energized transformer, we use instantaneous settings at the feeder breaker relay. Can the Littelfuse Arc-Flash Relays bring any benefit?

According to IEEE 1584, the arcing current can be as low as 38% of the available bolted fault current. If the instantaneous trip setting of the circuit breaker is greater than the arcing current, the breaker could take seconds or minutes to open, thus creating a potentially DANGEROUS arc flash condition. The PGR-8800, AF0500 and AF0100 can react in milliseconds regardless of the fault current, and initiate the tripping signal to open the breaker lowering the incident energy to a minimum.

Is there a specific relay to protect all of a switchgear bus section against arc flash?

The PGR-8800, AF0500 and AF0100 are all ideal for protecting switchgear bus sections. The PGA-LS20 or PGA-LS30 fiber sensors are often used for those applications, depending on the bus arrangement.

Are there control systems available that truly eliminate or control arc flash?

If the equipment is energized there is not a single system that does that.

Light Sensors and Current Transformers

What are the installation guidelines for the sensors?

The PGR-8800 and AF0500 Arc-Flash Relay and sensors are easily installed in retrofit projects and new switchgear with little or no re-configuration. Even elaborate systems with multiple power sources take minutes to configure using the relay's built-in USB interface software.

Generally, it is recommended to mount 1 or 2 sensors per cubicle to cover all horizontal and vertical bus bars, breaker compartments, drawers, and anywhere that there is potential for an arc-fault. Threading a fiber-optic sensor through the cabinets and in areas where point-sensor coverage is uncertain results in complete coverage and an added level of redundancy. Even if policy is to only work on de-energized systems, all maintenance area should be monitored to prevent potential damage and additional cost. At least once sensor should have visibility of an arc fault if a person blocks the other sensor(s).

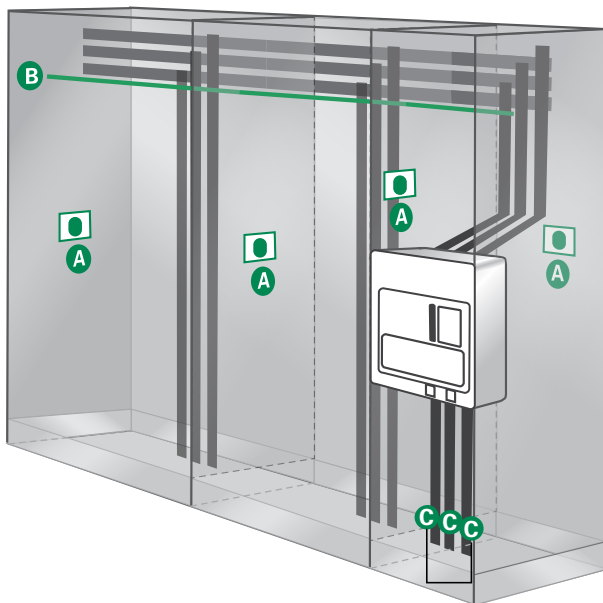

PGA-LS10 Point Sensor

Line-of-sight light sensor with a built-in LED to indicate sensor health or trip state. Comes standard with a 10 m (32 ft.) cable.



PGA-LS20, PGA-LS30 Fiber-Optic Sensor

A 360° fiber-optic sensor detects light along the active length of the cable and has a built-in LED to indicate sensor health or trip state. Recommended installation is along bus bars as well as in challenging spaces that have many compartments. Comes standard with two 10 m (32 ft.) cables.



Phase Current Transformers (Optional, PGR-8800 only)

Phase Current Transformers (CTs) are required to detect phase currents. When retrofitting systems, existing CTs with a 5 A secondary can be used.

Below are some additional guidelines:

- First determine sensor placements, then consider zones.
- Ensure sensors and cables are not blocked by objects, either fixed or movable.
- Do not place sensors or fiber cable on live or energized components.
- Choose a location that will minimize collection of foreign debris and easy access for maintenance, if needed.
- Use care when handling, pulling, and securing cables.
- Avoid sharp bends (< 5 cm) and high temperature (>80°C).
- Consider placements around air-magnetic circuit breakers.
- Consider movable parts and area accessible to personnel for commissioning, testing, inspecting, etc.
- Even though the sensors and cables have no exposed live parts are fully insulated, the placement and routing must comply with industry standard requirements on over-surface (creep) and through-air (clearance).

What is a typical light sensitivity radius for a fiber-optic sensor?

This is a difficult metric to provide because the distance an arc can be detected by the fiber-optic sensor is dependent on many variables. However, the PGA-LS20 and PGA-LS30 fiber-optic sensors are factory calibrated so that it will have the same detection range as the PGA-LS10 when 60 cm (a standard section width) is exposed to the arc flash. In other words, a 3 kA arc can be detected from a distance of 2 m from the fiber assuming that the light is incident on 60 cm of fiber. However, the PGA-LS20 and PGA-LS30 also has an adjustment screw that allows the user to calibrate the fiber-optic sensor to be more sensitive (for smaller sections) or less sensitive (for larger ones) so that the characteristic matches that PGA-LS10 point sensors. We recommend a minimum of 20 cm of fiber exposed per section.

The sensor is calibrated at the factory for 60 cm of fiber in each monitored compartment. When using the fiber-optic sensor in compartments with less than 60 cm of fiber, the sensitivity may have to be adjusted. The sensor is unable to differentiate between 10,000 lux hitting 60 cm of fiber and 30,000 lux hitting 20 cm of fiber— the same amount of light is transmitted through the fiber to the receiver. To achieve the desired sensitivity, the receiver (with the black thumb nut) must be adjusted.

Is there a maintenance schedule for the sensors?

Each sensor has an internal health LED. Its purpose is to verify the continuity of the sensor cabling and the internal sensor circuitry. This 'health check' circuit will not detect dust buildup on the sensor. There are several ways to mitigate dust buildup. A sensor mounted at the top of an enclosure looking down is optimal. This configuration will not collect much dust in most cabinet installations, due to intensity of an arc combined with the reflections off the metal walls (even a dirty sensor will collect a great deal of light).

Sensors must be cleaned in order to maintain consistent sensitivity. Sensor cleaning should be part of regular maintenance and should be performed via compressed air or dry wipe down. A maintenance routine can be implemented to clean sensors at a set interval that is aligned with industry standard recommendations, such as NFPA 70B, Recommended Practice for Equipment Maintenance.

A more proactive approach could also be used by putting the relay into Service Mode and shining a bright light on each sensor. A trip will be indicated if the sensor is able to detect the light but the breaker will not be tripped. If the relay light isn't indicating a trip then cleaning is necessary.

At what intensity of light will the Littelfuse Arc-Flash Relays indicate or trip?

The PGR-8800, AF0500 and AF0100 can be configured to trip between 10 klux and 25 klux. The relay's sensor LEDs can be configured to indicate at various levels below the trip level to warn that light intensity is approaching the trip level.

The fiber-optic sensor has an adjustable sensitivity (in addition to the relay sensitivity dial) that could be used to increase the sensitivity for a given length of fiber to levels below and above the relay setpoint.

How would the fiber-optic sensors be installed in switchgear that is shipped in groups? Do these sensors come in various lengths or with repeaters?

The fiber-optic sensors have two parts, an electrical cable connection to the relay and the light-sensitive fiber-optic cable. Splitting a fiber is a challenge because a bad splice can result in decreased or increased sensitivity and failure to operate or nuisance tripping. Shipping splits should be wired so that the fiber-optic sensor cable does not traverse multiple sections. The electrical part of the sensor, connecting the sensor to the relay, can be up to 50 m long and is much easier to connect at the final installation as well as much more durable than optical fiber. It is important to remember that a light-collecting fiber-optic cable behaves quite differently from a transmission-only shielded fiber-optic cable.

The latter case is more frequently used, especially in telecommunications industries and can have very large lengths, but in that case light is fed directly into the tube at a low angle of incidence and losses along the cable are very low. For the PGA-LS20 and PGA-LS30 fiber-optic sensors, the entire fiber-optic cable is designed to absorb light incident on the surface, bend the light to trap it in the cable, and then keep it in the cable. However, light is lost along the length of the cable and the longer the light must travel along the cable, the more light is lost. The active lengths of the PGA-LS20 and PGA-LS30 are 8 m and 18 m respectively. Repeaters are not available as the cost may be too high compared to installing a second fiber-optic sensor. Repeaters may cause timing issues for the sensor-check signal.

How do you test the sensors? Are they fail-safe?

A sensor-check circuit in every Littelfuse Arc-Flash Relays tests the sensor once per second to verify that the sensor assembly is functioning correctly and that it is connected. The signal is sent from the relay along the cable to the sensor which activates an internal LED. A failure in the sensor circuitry or cable would result in a loss of check signal. The PGR-8800, AF0500 and AF0100 recognize this signal loss as a missing sensor and will indicate an error condition on the sensor, relay faceplate and the online or error output will change state. The user can decide what to do with this relay output and whether it will trip the system or simply signal an alarm. The fiber-optic sensor works the same way except that the signal travels through the length of the fiber-optic cable so a break or crimp in that cable is also detected.

For the PGR-8800, sensors can be tested individually by putting the relay into Service mode and shining a bright light source on the sensor. A trip will be indicated if the sensor is able to detect the light but a trip signal will not be sent to the breaker. A high-power flashlight can serve to verify the sensors are properly detecting light. The power required on the flashlight is difficult to quantify because of the way the light is spread and focused, but a 3 million candela flashlight has proven more than sufficient for use on point sensors.

What is the purpose of the Current Transformers (CTs) and are they required?

The purpose of the CTs is to validate an arcing condition, although CTs are not required for operation. The PGR-8800, AF0500 and AF0100 relays can detect light only to send a trip signal. If the CTs are used with the PGR-8800, the relay will only send a trip signal if both light and overcurrent conditions are detected. In applications where high-intensity light is a possible, overcurrent detection can be used to prevent nuisance tripping.

Resistance Grounding

Would a ground fault on the main switchgear act as an arc-flash relay?

HRG systems eliminate arc-flash hazards associated with ground-faults per IEEE Std 141-1993. Even though tests have shown that HRG systems also reduce the arc-flash energy with phase-to-phase arcing faults, it can not be used to reduce PPE. Arc-Flash Relays can be used to identify these arcing conditions and significantly reduce arc-flash hazards. In many applications, both are used to increase uptime and protection.

Can we have more than 5A L-G fault available in HRG in any circumstances?

The maximum ground-fault current is physically limited to the value of the resistor, assuming no resistance in the fault and return path. For example, on a 480V system, for a ground-fault current of 5A, the resistor value is $277V / 5A = 55.4$ ohms. The 55.4 ohm resistor sets a maximum ground-fault current of 5A. However, it is typically lower due to either fault resistance and/or resistance in return path. In some older facilities where the return path is weak, a lower resistance value is used to allow for a higher ground-fault current.

Is there protection (resistance grounding) for delta circuits?

HRG systems are only used on 3-wire systems, either wye with floating neutral or delta. If used on wye systems, the resistor is simply directly connected to the neutral bushing. If it is a delta system, typically a zig-zag transformer is used to create a neutral point (or three single-phase transformers are used). In any case, a neutral point, which is used to connect the resistor.

The code only allows HRG if you didn't have neutral to ground loads (i.e. 277 V).

Would this only be applied on 3-wire systems?

Correct, the NEC prohibits using HRG systems on systems with line-to-neutral loads. The reason is that the elevated neutral voltage, which occurs during a ground fault, may back-feed a circuit causing a dangerous condition. However, CEC allows HRG systems on these systems if the entire system is tripped offline during a ground fault.

How do you address the system-leakage capacitance on HRGs, especially at medium-voltage levels?

You are correct that at medium-voltage, the system leakage capacitive current increases, which is a function of voltage. Fortunately, this has been well documented over the years and tables are used to estimate the leakage current. Depending on this value, the ground-fault on a HRG system may not be recommended to remain on system.

Is it possible to apply HRG to a distribution transformer in order to minimize the arc-flash hazard when working on the secondary of the transformer?

High-Resistance Grounding (HRG) has some limitations. For example, it is difficult to implement on systems with line-to-neutral loads. Another limitation is the amount of current flow during a ground-fault. HRG limits the current to typically 10A or less, which may not be enough to detect on your distribution system. If these are not issues, consider using HRG systems. However, perform a detailed engineering study to ensure other limitations (such as voltage shift) are acceptable.

If you have a neutral-grounding resistor, is an arc-flash relay also recommended?

Yes, because the NGR only reduces or eliminates arcing ground faults. For the other type of arcing faults, phase faults, a Littelfuse Arc-Flash Relay can be used to provide maximum protection. Typically 95% of all faults are ground faults, so the NGR reduces or eliminates most of the risk and the Littelfuse Arc-Flash Relays provides the 5% protection in the switchgear.

Safety Regulations

Do arc-flash relays lower the Personal Protective Equipment (PPE) required?

In order to lower the amount of PPE required, the incident energy must be reduced. There are two ways to lower the incident energy of an arc-flash event, reducing the fault current or the clearing time and reducing the available energy. Reducing the available energy can be achieved by using current-limiting fuses and, for single-phase faults, resistance grounding.

Reducing the clearing time typically is not possible when using overcurrent protection due to system coordination requirements. Current-based protection must have sufficient delay to prevent unnecessary tripping on momentary overload or current spikes, thus losing valuable reaction time.

Arc Flash relays resolve this issue by detecting light, which allows for a fast reaction time. The PGR-8800 and AF0500 relays can detect an arcing condition and send a trip signal to the circuit breaker within 1 ms. The AF0100 can send a trip signal in as low as 3 ms. This detection time is much faster than standard protection and circuit breakers, which means using a Littelfuse Arc Flash relay in combination with a circuit breaker will lower the incident energy. This results in an increase in worker safety, less fault damage, and improved uptime. Since the arc-flash hazard has decreased, the associated PPE may also be lowered. The exact amount will depend on user setpoints, so it must be modeled in the system to determine the new incident energy and PPE.

Can the Littelfuse Arc-Flash Relays eliminate the need for PPE 3 or 4 clothing?

Please use our reduction workbook to learn more about incident energy reduction at Littelfuse.com/ArcFlash.

Can the Littelfuse Arc-Flash Relays reduce PPE required if only walking in front of the equipment, or opening the cabinet to read a nameplate?

If the worker is within the flash protection boundary of the exposed (line of sight) energized part, then the PPE category on the label must be used. If the door is closed or cover is on, check NFPA 70E Table 130.7(C)(15)(a) or (b) for a reduction in PPE category.

What are the regulatory agencies' opinion on arc-flash relays on life safety and critical circuits?

Hospitals and health care facilities are not exempted from OSHA safety requirements. They rely on the experience and reputation of the Professional Engineer's assessment.

When designing a safety protocol, should low-fault current / long clearing-time hazard and a high-fault current / short clearing-time hazard with the same incident energy be treated differently?

If the incident energy is the same, No. However, if the incident energy is more or less, NFPA 70E requires the worker to use arc rated clothing equal to or greater than the possible maximum incident energy.

Is there a recommendation as to how often you need to update the arc-flash label?

NFPA 70E Article 130.5 requires the arc-flash analysis to be updated when major modifications occur and reviewed every 5 years, whichever occurs first.

Our facility completed an arc-flash assessment and there are areas with an incident energy of 40 cal / cm². Will the Littelfuse Arc-Flash Relays reduce those levels and will that allow us to work on energized equipment and reduce the amount of PPE required?

It is possible, but this must be evaluated on a case-by-case basis to determine the resulting reduction in arc-flash energy. We recommend you contact the engineer or engineering firm that performed the assessment and request them to re-run the study at that equipment using the PGR-8800, AF0500 or AF0100 relay to lower the energy and use our Arc-Flash Energy Reduction Workbook, which can be found on Littelfuse.com/ArcFlash.

If using this arc-flash relay as the only method to protect personnel from arc flash, should the arc-flash relay be tested and have a Safety Integrity Level? (SIL)

We don't recommend that the PGR-8800, AF0500 or AF0100 be used as the only method to protect personnel from arc flash. Adequate PPE should be worn based on the results of an arc-flash study. Resistance grounding is highly recommended to eliminate single phase-to-ground arc flashes. Current-limiting fuses and relays such as our Littelfuse Feeder and Motor Protection Relays with maintenance mode settings or dual set-point groups are also highly recommended.

PGR-8800 SERIES (D1000)

Arc-Flash Relay



Description

The PGR-8800 Series is a microprocessor-based relay that limits arc-fault damage by detecting the light from an arc flash and rapidly tripping. Phase-current-transformer inputs are provided for current-constrained arc-flash protection and, when so equipped, a programmable definite-time overcurrent function can be enabled. An optical sensor on the PGR-8800 and adjustable trip level reduce the chance of nuisance tripping by setting a threshold for ambient light. Sensors, inputs, and connections are monitored to ensure fail-safe operation. A secondary solid-state trip circuit provides a redundant trip path. A USB port is used for configuration and access to event logs and graphs.

Simplified Circuit Diagram

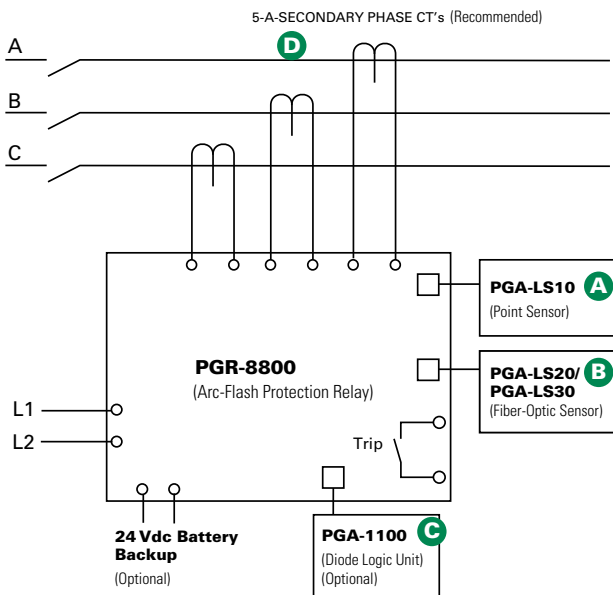

Optical Sensors

The PGR-8800 accepts both PGA-LS10 and PGA-LS20/PGA-LS30 optical sensors, designed to collect light over a wide angle and with high sensitivity. For fast fault location, front-panel and sensor LED's indicate sensor health and which sensor detected an arc fault.

Sensor Placement

The PGR-8800 Arc-Flash Relay and sensors are easily installed in retrofit projects and new switchgear with little or no re-configuration. Even elaborate systems with multiple power sources take minutes to configure using the relay's built-in USB interface software.

Generally, it is recommended to mount 1 or 2 sensors per cubicle to cover all horizontal and vertical bus bars, breaker compartments, drawers, and anywhere that there is potential for an arc-fault. Threading a fiber-optic sensor through the cabinets and in areas where point-sensor coverage is uncertain results in complete coverage and an added level of redundancy. Even if policy is to only work on de-energized systems, all maintenance areas should be monitored to prevent potential damage and additional cost. At least one sensor should have visibility of an arc fault if a person blocks the other sensor(s).

Ordering Information

ORDERING NUMBER	DESCRIPTION
PGR-8800-00 (UL, CE, CSA, RCM)	Arc-Flash Relay
PGR-8800-00-CC (UL, CE, CSA, RCM)	Arc-Flash Relay, Conformally Coated
ACCESSORIES	REQUIREMENT
PGA-LS10	Required*
PGA-LS20, PGA-LS30	Required*
PGA-1100	Optional
Current Transformer	Recommended

*At least one sensor is required. However, the exact number of sensors for proper coverage depends on the application.

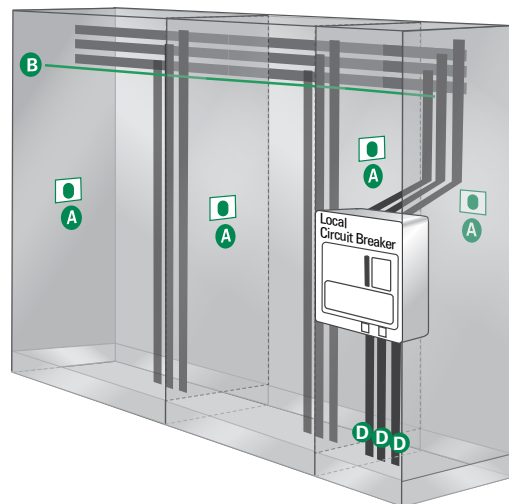

PGR-8800 SERIES (D1000)



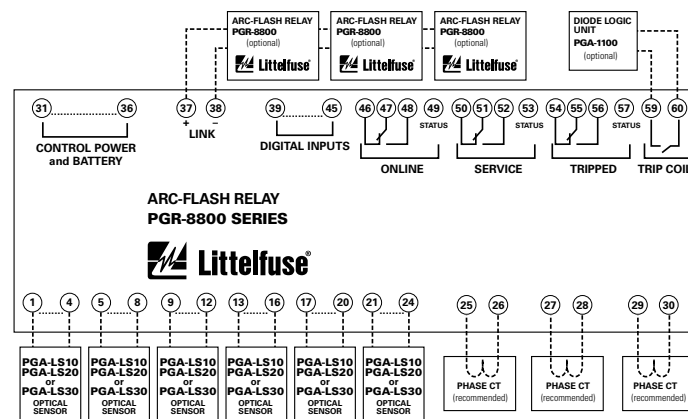

Features & Benefits

FEATURES	BENEFITS
Arc-Flash trip time <1 ms	Limits arc-flash damage and risk of injury
Multiple sensors (up to 24)	Single module can monitor 6 sensors. Up to 4 PGR-8800 units can be linked into one system
Fail-safe system	Continuous monitoring of optical sensors and inputs ensures protection
Redundant trip circuit	Solid-state backup arc-detection circuit adds a second layer of safety
Adjustable light sensitivity	Allows for operation in bright environments and maximum sensitivity in dark environments
LED indication (on unit and each sensor)	18 LEDs provide at-a-glance status for module and I/O state
Current detection	Phase-CT inputs provide overcurrent protection and prevent nuisance trips
Optical detection	Point and fiber-optic sensors provide wide detection area with sensor health trip indication
Digital inputs (6)	Two each: remote trip, inhibit, and reset inputs
Service mode	Allows for system test without tripping
Trip coil contact	Solid-state 24-300 Vdc/24-300 Vac IGBT
Indication contacts	Form C and status outputs
USB interface	Data logging and configuration software uses a USB interface with no drivers or software installation
Built-in sensor	Can be used in single-sensor systems, as a seventh sensor, and for calibration
Universal power supply/Battery backup	100-240 Vac, 14-48 Vdc, or 110-250 Vdc supply accepted. Ability to charge and run off an external, user-supplied 24 Vdc battery
Data logging	On-board event recorder helps with system diagnostics
Modbus	Remotely view measured values, event records & reset trips
Upstream Tripping	Ability to trip upstream device if the local breaker fails to clear the fault

Wiring Diagram



Accessories

- A**  **PGA-LS10 Point Sensor**
Line-of-sight light sensor detects an arc as small as 3 kA within a 2-m half-sphere. Sensor health and trip indication. Dimensions: See PGR-8800 Manual
- B**  **PGA-LS20/PGA-LS30 Fiber-Optic Sensor**
360° light sensor for tricky installations with many shadows or to run along bus bars. Sensor health and trip indication. Dimensions: See PGR-8800 Manual
- C**  **PGA-1100 Diode Logic Unit**
This module allows multiple PGR-8800 relays to trip the same breaker, for example an upstream or a tie-breaker. Dimensions: **H** 80 mm (3.15"); **W** 20 mm (0.79"); **D** 70 mm (2.76")
- D**  **Current Transformers**
Eliminate nuisance arc-flash trips and use for overcurrent protection.

Specifications

- IEEE Device Numbers**
 - Input Voltage**
 - Dimensions**
 - Optical Trip Settings**
 - Current Trip Setting (A)**
 - Indication Contact Mode**
 - Trip Coil Voltage⁽¹⁾**
 - Trip Coil Contact Mode**
 - Redundant Trip Circuit**
 - Input Monitoring**
 - USB Interface**
 - Trip, Reset, Service Buttons**
 - Expandable System**
 - Warranty**
 - Mounting**
 - Approvals**
- Overcurrent (50), Arc Flash (AFD)
100-240 Vac, 14-48 Vdc, and 110-250 Vdc
H 130 mm (5.1"); **W** 200 mm (7.9"); **D** 54 mm (2.1")
9-25 klux, 800 μs-20 s
Programmable
Fail-safe
24-300 Vdc, 24-300 Vac
Selectable fail-safe or non-fail-safe
Standard feature
Standard feature
Standard feature
Link up to 4 PGR-8800 units
5 years
Surface, DIN (with D0050 adapter clips)
UL, CE, CSA, RCM, FCC, DNV type approval, ABS type approval

NOTE (1) - Contact Littelfuse for trip coil voltages higher than 300 Vdc/Vac.

Littelfuse reserves the right to make product changes, without notice. Material in this document is as accurate as known at the time of publication. Visit Littelfuse.com for the most up-to-date information.

AF0500 SERIES

Arc-Flash Relay

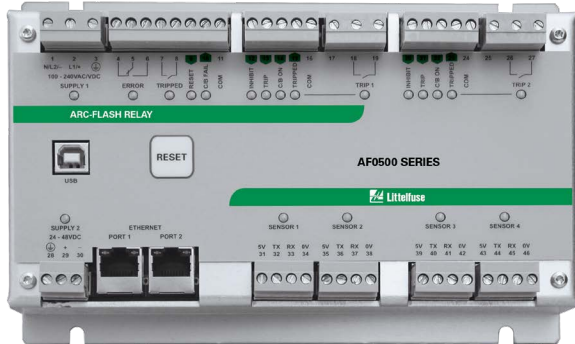

Features & Benefits

FEATURES	BENEFITS
4 arc sensor inputs	Supports both point and fiber sensors
Arc-Flash trip time <1 ms	Limits arc-flash damage and risk of injury
2 IGBT high speed trip outputs	Supports applications such as upstream breaker tripping or tie breaker tripping
Universal Power Supply	100-240 Vac, 24-48 Vdc, or 110-250 Vdc supply
Fail-safe system	Continuous monitoring of optical sensors and inputs ensures protection
LED indication (on unit and each sensor)	Trip and sensor status indicated both on relay and sensors
Discrete wire networking	Multiple AF0500 units can be interconnected to form a system
USB interface	Data logging and configuration software uses a USB interface with no drivers or software installation
Data logging	On-board event recorder for system diagnostics (2048 log lines)
Ethernet interface	Modbus [®] TCP communication

Ordering Information

ORDERING NUMBER	DESCRIPTION
AF0500-00	Arc-Flash Relay
AF0500-00-CC	Arc-Flash Relay, Conformally Coated

ACCESSORIES	REQUIREMENT
PGA-LS10	Required*
PGA-LS20, PGA-LS30	Required*
PGA-1100	Optional

Description

The AF0500 is a microprocessor-based arc-flash relay that limits arc-fault damage by detecting the light from an arc flash and rapidly tripping the feeder breaker. The unit is well suited for switchgear, transformer and power converter applications.

Sensors, inputs, and connections are health monitored to ensure fail-safe operation. A secondary solid-state trip circuit provides a redundant trip path. A USB port is used for configuration and access to event logs.

AF0500 includes an Ethernet interface and supports Modbus[®] TCP communication. Zone tripping, upstream breaker tripping and tie breaker tripping applications can be easily configured.

A number of control inputs allows interconnection of multiple AF0500 units to form a system.

Optical Sensors

The AF0500 accepts both PGA-LS10 point sensors and PGA-LS20/PGA-LS30 fiber-optical sensors. Thus any combination of fiber or point sensors is supported.

For fast fault location, front-panel and sensor LEDs indicate sensor health and which sensor detected an arc fault.

Sensor Placement

The AF0500 Arc-Flash Relay and sensors are easily installed in retrofit projects and new switchgear with little or no re-configuration. Simple applications work straight out of the box with no need of PC configuration. More complex systems with multiple power sources are configured using the relay's built-in USB interface software.

Generally, it is recommended to mount 1 or 2 sensors per cubicle to cover all horizontal and vertical bus bars, breaker compartments, drawers, and anywhere that there is a risk for an arc fault. Threading a fiber-optic sensor through the cabinets and in areas where point-sensor coverage is uncertain results in complete coverage and an added level of redundancy. Even if policy is to only work on de-energized systems, all maintenance areas should be monitored to prevent potential damage and additional cost.

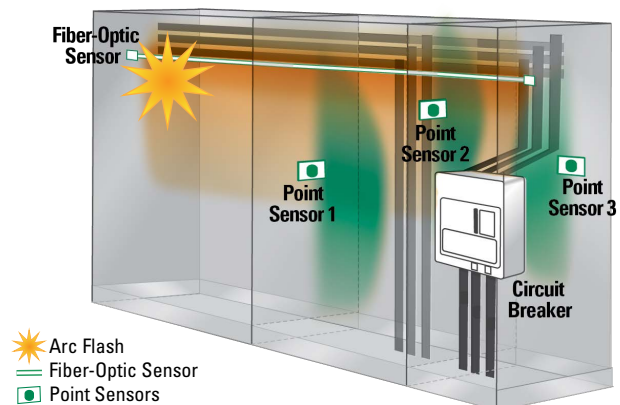

AF0500 SERIES

Applications

Zone Tripping

AF0500 can trip 2 separate zones. Sensors can be assigned to the zones individually through PC configuration.

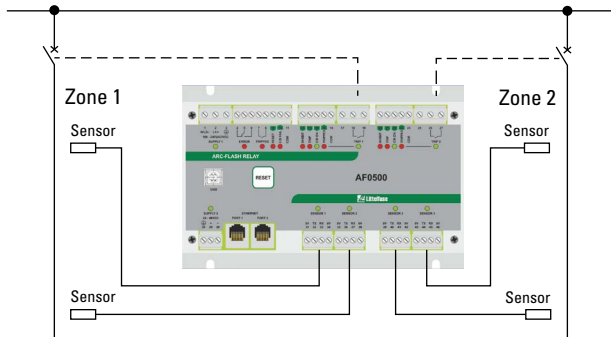

Upstream Breaker Tripping

In case of failure of the local circuit breaker to open, another trip command is sent after a short delay to an upstream breaker to clear the fault.

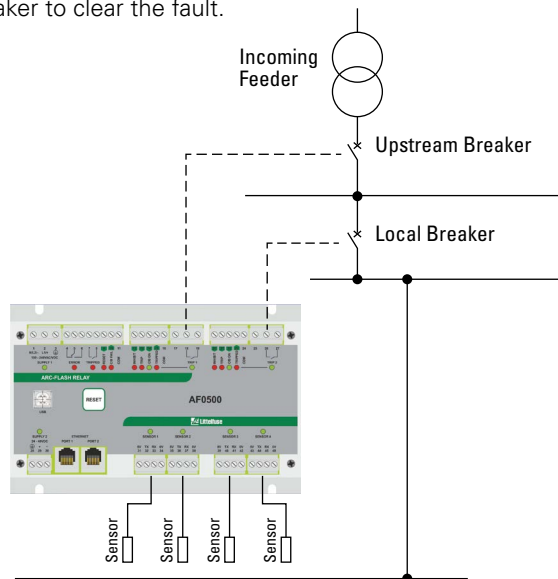

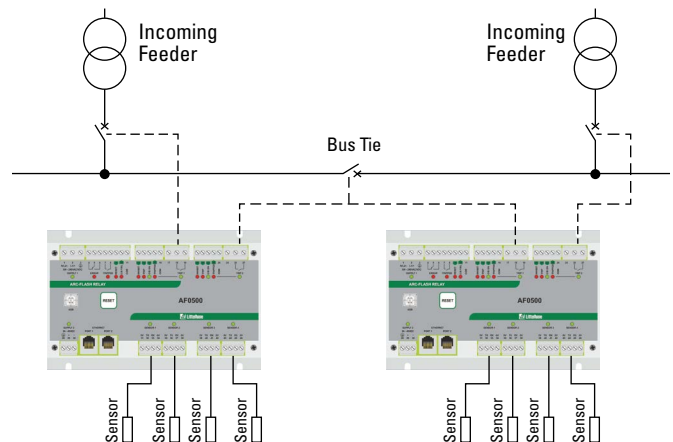

Tie Breaker Tripping

In case of an arc in one section of the switchboard, the AF0500 can trip both the incoming feeder and the tie breaker simultaneously. Thus the affected part of the switchboard is isolated from the non-affected part. Alternatively, a single relay can connect to the tie breaker and the AF0500 relays can communicate a trip to the tie breaker using the digital I/O interface.



Accessories

- 
PGA-LS10 Point Sensor
 Line-of-sight light sensor detects an arc as small as 3 kA within a 2-m half-sphere. Includes Sensor health and trip indication.
- 
PGA-LS20/PGA-LS30 Fiber-Optic Sensor
 360° light sensor to run along bus bars. Sensor health and trip indication.
- 
PGA-1100 Diode Logic Unit
 This module allows multiple arc-flash relays to trip a common breaker, for example a tie-breaker.

Specifications

Power Supply

Universal

100 to 240 Vac (+10%, -15%) 50/60 Hz, 20 VA,
110 to 250 Vdc (+10%, -20%) 8 W

Low Voltage

24 to 48 Vdc (+10%, -20%), 4 W

Sensor Inputs

4 light sensor inputs for PGA-LS10, PGA-LS20
and PGA-LS30 sensors

Trip Outputs

2 IGBT switches

UL Rating

120/240 Vac, 1800 VA, 0.75 A maximum continuous,
125/250 Vdc, 138 VA, 0.75 A maximum continuous

Supplemental Rating

Make/Carry

30 A for 0.2s

Voltage Rating

24 to 300 Vac, 24 to 300 Vdc

Current Rating

20 A for 2 s, 10 A for 5 s

Communication

Ethernet, 2 ports with internal Ethernet switch,
Modbus® TCP

Dimensions

H 130 mm (5.1"); **W** 200 mm (7.9"); **D** 54 mm (2.1")

Shipping Weight

0.9 kg (2 lb.)

Operating Temp.

-40°C to +70°C (-40°F to 158°F)

Approvals

UL Listed (UL508), CE, RCM, FCC, CSA

Warranty

5 years

Mounting

Surface, DIN (with optional D0050 adapter clips)

AF0100 SERIES

Arc-Flash Relay



Simplified Circuit Diagram

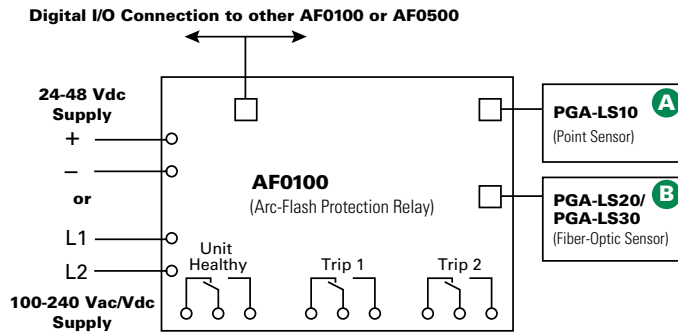

Ordering Information

ORDERING NUMBER	DESCRIPTION
AF0100-00	Arc-Flash Relay, Universal Supply
AF0100-10	Arc-Flash Relay, 24-48 Vdc

Specifications

Input Voltage	100-240 Vac/Vdc, 24-48 Vdc
AF0100-00	100-240 Vac/Vdc, 24-48 Vdc
AF0100-10	24-48 Vdc
Dimensions	H 90 mm (3.5"); W 128 mm (5.0"); D 60 mm (2.4")
Trip, Error Relays	Form C, 250 Vac/30 Vdc, 6 A resistive
Sensitivity	10-25 klux programmable
Mounting	Surface, DIN rail
Operating Temperature	-40°C to +70°C (-40°F to 158°F)
Shipping Weight	1.0 kg (2.2 lb.)
Certifications	Contact factory
Warranty	2 years

Description

The AF0100 Series arc-flash relay is a cost-effective solution that reduces arc-fault damage by detecting the light from an arc flash and rapidly tripping. Two remote light sensors can be connected to one relay and multiple AF0100 and/or AF0500 relays can be connected to monitor additional sensors, providing complete coverage for a wide range of applications. The compact, DIN-rail or surface-mountable body makes this an ideal solution for equipment manufacturers.

Two isolated Form-C contacts are provided for applications with multiple devices that must be tripped. This is especially useful for generator applications where the generator and breaker need to be tripped in case of an arc flash.

The AF0100 accepts PGA-LS10 point sensors and PGA-LS20/PGA-LS30 fiber-optic sensors in any combination. Sensor health is continuously monitored to ensure fail-safe operation. A solid-state redundant trip circuit provides an internal fail-safe mechanism and fast arc-flash response during power up.

Front-panel and sensor LEDs indicate sensor health and fault location.

Features & Benefits

FEATURES	BENEFITS
Compact	Fits into a wide range of arc-flash applications
Two optical sensor types	Point sensors or fiber-optic sensors can be used in any combination for coverage flexibility
Dual sensor inputs	One relay can monitor two arc-flash sensors
Adjustable light sensitivity	Allows for operation in bright environments and maximum sensitivity in dark environments
Discrete wire networking	Multiple AF0100 or AF0500 units can be interconnected to form a system
Fail-safe system	Continuous monitoring of optical sensors and inputs ensures protection
USB interface	Configuration software is easy to use with no drivers or software installation
Unit health	Ensures continuous protection with self diagnostic and remote unit-healthy indication
LED Indication	Trip and sensor status indication both on relay and sensors









Accessories

- A** **PGA-LS10 Point Sensor**
Line-of-sight light sensor detects an arc as small as 3 kA within a 2-m half-sphere. Includes sensor health and trip indication.
- B** **PGA-LS20/PGA-LS30 Fiber-Optic Sensor**
360° light sensor to run along bus bars. Includes sensor health and trip indication.

ARC-FLASH RELAY COMPARISON GUIDE

Reliable Operation with Built-In Redundancies

When you are entrusting a safety device to protect equipment from catastrophic damage, it is important to know that it will operate as expected. Littelfuse Arc-Flash Relays do this by having built-in redundancies and health monitors, making maintenance and installation tasks faster, more efficient and helping to minimize downtime.

	AF0100	AF0500	PGR-8800
 Redundant Internal Trip Path <ul style="list-style-type: none"> Two internal trip paths for added reliability—if the microprocessor trip path fails, the backup analog trip path will seamlessly take over, sending an alarm notification to operators Backup analog trip path initializes very quickly upon power up, ensuring protection is enabled while energizing the system when hazard risk is higher 	✓	✓	✓
 Health Monitoring <ul style="list-style-type: none"> Continuously monitors connection to trip coil to ensure path is intact LED indication of sensors' "Ready" or "Tripped" status on sensor and relay Sensors are durable enough to withstand a detected arc-flash event 	✓	✓	✓
 Reliable Light Detection <ul style="list-style-type: none"> Two types of light sensors (point and fiber-optic) for different applications Adjustable light-level and wide-angle detection add flexibility Durable and flexible sensor design eliminates breakage and re-work 	✓	✓	✓
 High-Speed (<1 ms) Trip <ul style="list-style-type: none"> Rapidly initiate the removal of power to reduce the incident energy of the arc flash 		✓	✓
 Upstream Tripping <ul style="list-style-type: none"> Ability to trip upstream device if the local breaker fails to clear the fault 		✓	✓
 Data Logging <ul style="list-style-type: none"> Quickly assess the factors that led to a trip in order to get back online quickly 		✓	✓
 Optional Current Detection for Fault Verification <ul style="list-style-type: none"> Avoid nuisance tripping with current-supervised arc-flash trips Phase Current Transformers for overcurrent detection Two user-defined definite-time overcurrent protection levels and times 			✓
 Tie Breaker Tripping <ul style="list-style-type: none"> Ability to trip both incoming feeder and tie breaker when arc is detected in one section of a switchboard Affected part of the switchboard is isolated from the non-affected part 		✓	
 Zone Tripping <ul style="list-style-type: none"> Ability to trip 2 separate zones with 1 relay Sensor zone assignment through simple PC configuration and/or digital inputs and outputs 		✓	

For more information, visit
www.littelfuse.com/ArcFlash

Additional technical information and application data for Littelfuse protection relays, fuses and other circuit protection and safety products can be found on www.littelfuse.com/protectionrelays. For questions, contact our Technical Support Group (800-832-3873). Specifications, descriptions and illustrative material in this literature are as accurate as known at the time of publication, but are subject to changes without notice. All data was compiled from public information available from manufacturers' manuals and datasheets.