



Parameter	Rating	Units
Breakdown Voltage BV_{CEO}	30	V
Current Transfer Ratio (Min)	100	%
Saturation Voltage	0.3	V
Input Control Current	0.2	mA

Features

- 100mA Continuous Load Rating
- 1500V_{rms} Input/Output Isolation
- Small 4-Pin SOP Package
- Tape & Reel Version Available
- Flammability Rating UL 94 V-0

Applications

- Loop Detect
- Ringing Detect
- Sensor Circuitry
- Instrumentation
- Multiplexers
- Data Acquisition
- I/O Subsystems
- Industrial Control

Description

CPC1001N is a unidirectional input optocoupler with a single transistor output. Current transfer ratios range from 100% to 800%.

Approvals

- UL Recognized Component: File E76270
- CSA Certified Component: Certificate 1172007
- TUV EN 62368-1: Certificate # B 082667 0008

Ordering Information

Part #	Description
CPC1001N	4-Pin SOP (100/Tube)
CPC1001NTR	4-Pin SOP Surface Mount (2000/Reel)

Pin Configuration

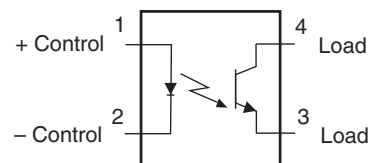

Absolute Maximum Ratings @ 25°C

Parameter	Ratings	Units
Input Power Dissipation ¹	150	mW
Input Control Current Peak (10ms)	5	mA
	1	A
Reverse Input Voltage	5	V
Phototransistor ²	150	mW
Isolation Voltage, Input to Output	1500	V _{rms}
Operational Temperature, Ambient	-40 to +85	°C
Storage Temperature	-40 to +125	°C

¹ Derate linearly 1.33 mW / °C

² Derate linearly 2.00 mW / °C

Absolute Maximum Ratings are stress ratings. Stresses in excess of these ratings can cause permanent damage to the device. Functional operation of the device at conditions beyond those indicated in the operational sections of this data sheet is not implied.

Typical values are characteristic of the device at +25°C, and are the result of engineering evaluations. They are provided for information purposes only, and are not part of the manufacturing testing requirements.

Electrical Characteristics @ 25°C

Parameters	Conditions	Symbol	Min	Typ	Max	Units
Output Characteristics						
Phototransistor Blocking Voltage	I _{CEO} =10μA	BV _{CEO}	30	90	-	V _P
Phototransistor Output (Dark) Current	I _F =0mA, V _{CEO} =5V	I _{CEO}	-	9	500	nA
Saturation Voltage	I _F =1mA, I _C =1mA	V _{CE(sat)}	-	-	0.3	V
Current Transfer Ratio	I _F =0.2mA, V _{CE} =0.5V	CTR	100	330	800	%
Output Capacitance	V _{CEO} =25V, f=1MHz	C _{OUT}	-	6	-	pF
Input Characteristics						
Input Control Current	I _C =0.2mA, V _{CE} =0.5V	I _F	-	0.1	0.2	mA
Input Voltage Drop	I _F =5mA	V _F	0.9	1.2	1.5	V
Input Reverse Current	V _R =5V	I _R	-	-	10	μA
Common Characteristics						
Input to Output Capacitance	-	C _{I/O}	-	3	-	pF

Switching Characteristics @ 25°C

Characteristic	Symbol	Test Condition	Typ	Units
Turn-On Time	t _{on}	I _F =2mA, V _{CC} =5V, R _L =1KΩ	1	μs
Turn-Off Time	t _{off}		30	

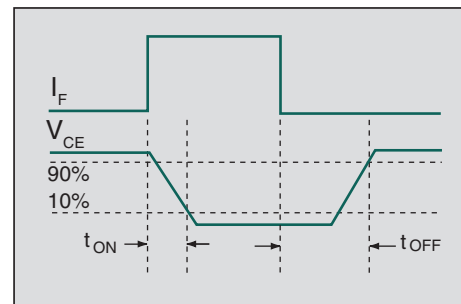
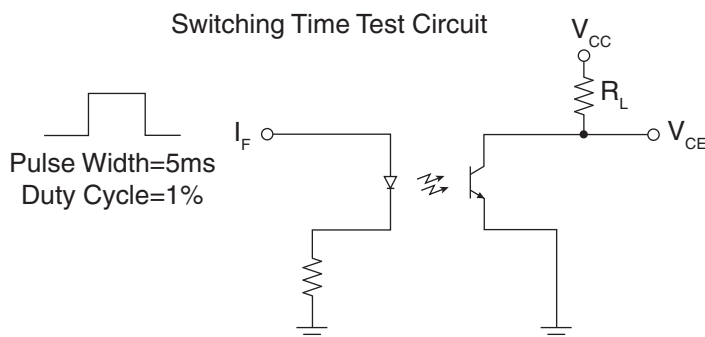

PERFORMANCE DATA*

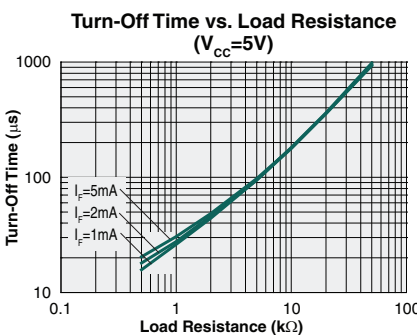
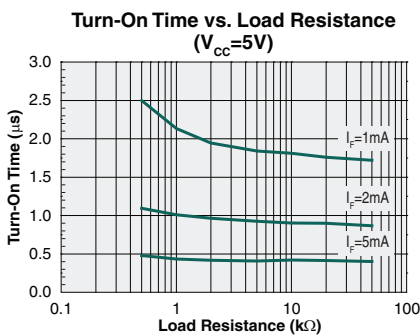
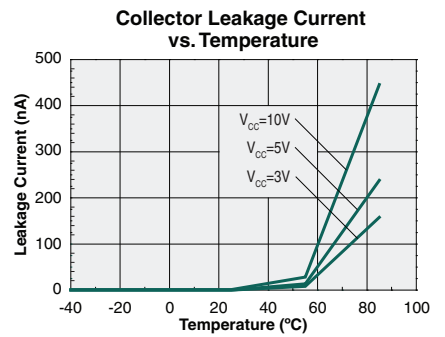
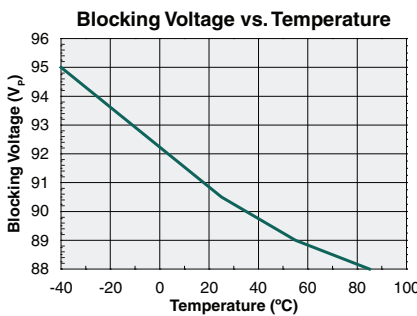
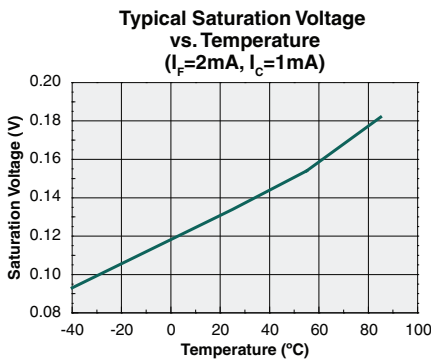
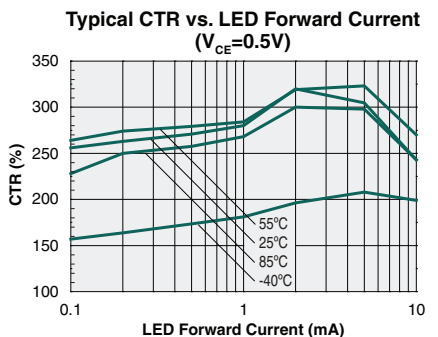
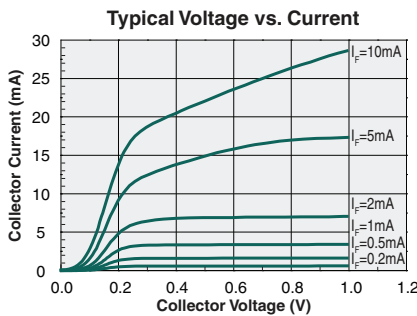
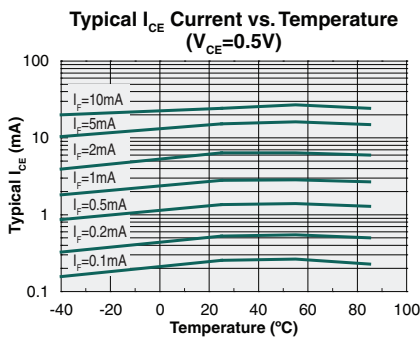
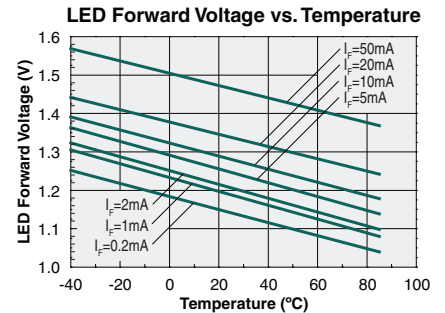
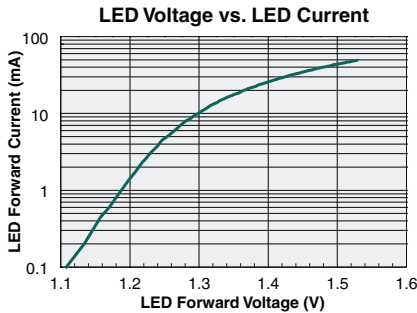
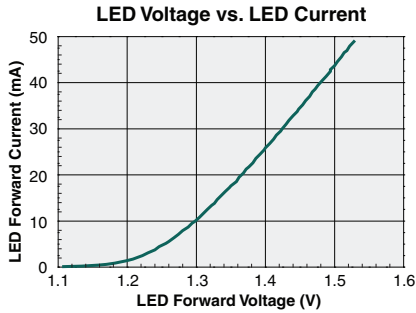

Refer to the Test Circuit on the previous page for these two graphs.

*Unless otherwise noted, data presented in these graphs is typical of device operation at 25°C.

Manufacturing Information

Moisture Sensitivity



All plastic encapsulated semiconductor packages are susceptible to moisture ingress. IXYS Integrated Circuits classifies its plastic encapsulated devices for moisture sensitivity according to the latest version of the joint industry standard, **IPC/JEDEC J-STD-020**, in force at the time of product evaluation. We test all of our products to the maximum conditions set forth in the standard, and guarantee proper operation of our devices when handled according to the limitations and information in that standard as well as to any limitations set forth in the information or standards referenced below.

Failure to adhere to the warnings or limitations as established by the listed specifications could result in reduced product performance, reduction of operable life, and/or reduction of overall reliability.

This product carries a **Moisture Sensitivity Level (MSL)** classification as shown below, and should be handled according to the requirements of the latest version of the joint industry standard **IPC/JEDEC J-STD-033**.

Device	Moisture Sensitivity Level (MSL) Classification
CPC1001N	MSL 3

ESD Sensitivity



This product is ESD Sensitive, and should be handled according to the industry standard **JESD-625**.

Soldering Profile

Provided in the table below is the **IPC/JEDEC J-STD-020** Classification Temperature (T_C) and the maximum dwell time the body temperature of these surface mount devices may be $(T_C - 5)^\circ\text{C}$ or greater. The Classification Temperature sets the Maximum Body Temperature allowed for these devices during reflow soldering processes.

Device	Classification Temperature (T_C)	Dwell Time (t_p)	Max Reflow Cycles
CPC1001N	260°C	30 seconds	3

Board Wash

IXYS Integrated Circuits recommends the use of no-clean flux formulations. Board washing to reduce or remove flux residue following the solder reflow process is acceptable provided proper precautions are taken to prevent damage to the device. These precautions include but are not limited to: using a low pressure wash and providing a follow up bake cycle sufficient to remove any moisture trapped within the device due to the washing process. Due to the variability of the wash parameters used to clean the board, determination of the bake temperature and duration necessary to remove the moisture trapped within the package is the responsibility of the user (assembler). Cleaning or drying methods that employ ultrasonic energy may damage the device and should not be used. Additionally, the device must not be exposed to halide flux or solvents.



MECHANICAL DIMENSIONS

CPC1001N

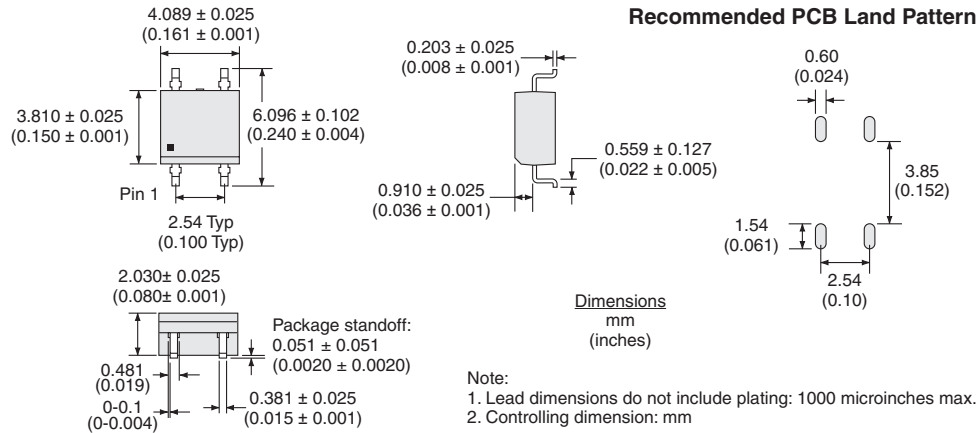

CPC1001NTR Tape & Reel

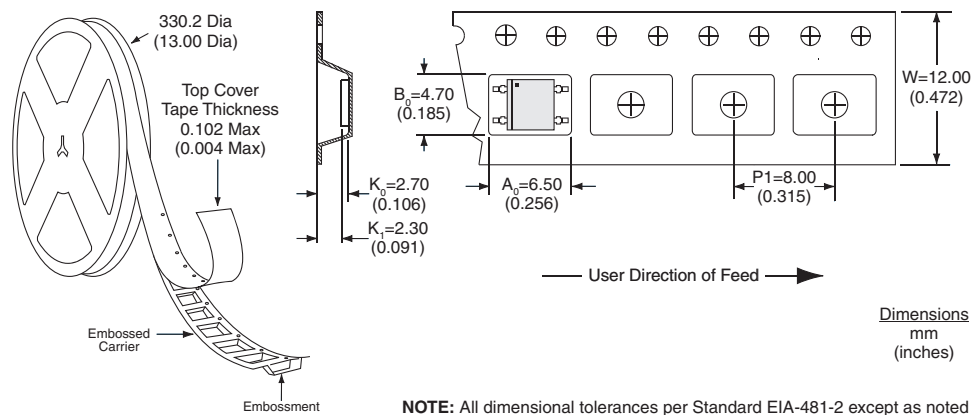

For additional information please visit our website at: <https://www.ixysic.com>