



Parameter	Rating	Units
Load Voltage	350	V_P
Load Current	120	mA_{rms} / mA_{DC}
On-Resistance (max)	25	Ω
Input Control Current	2	mA

Features

- Integrated Active Current-Limit Protection
- Thermal Shutdown
- Guaranteed Turn-On: 2mA Input Control Current
- 350V_P Blocking Voltage
- 3750V_{rms} Input/Output Isolation
- Small Surface Mount Package
- Low Drive Power Requirements
- Arc-Free With No Snubbing Circuits
- No EMI/RFI Generation
- Flammability Rating UL 94 V-0

Applications

- Telephony hook switch
- VoIP gateways, such as VoIP
- IP-PBXs
- Satellite and cable set-top boxes
- V.92 (and other standard) modems
- Fax machines
- Voicemail systems
- Embedded modems for POS terminals, automated banking, remote metering, vending machines, security, and surveillance
- Instrumentation
- Medical equipment—Patient/equipment isolation
- Aerospace
- Industrial controls

Pin Configuration

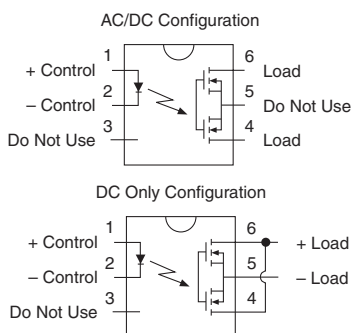

Description

The CPC1540 is a normally open (1-Form-A) Solid State Relay with an integrated current limit feature that can replace electromechanical relays while enhancing the robustness of wireline-interface applications.

Designed specifically to target the hook switch telephony market, the CPC1540 has a load voltage rating of 350V.

The relay is constructed using an efficient infrared LED for actuation control and an integrated monolithic die for the switch output. The die, fabricated in a high-voltage dielectrically isolated technology, comprises a photodiode array, switch control with active current limiting circuitry, and MOSFET switches. Active current-limit circuitry in the CPC1540 provides a thermal shutdown feature, offering excellent power-cross immunity for improved survivability in harsh environments.

These enhancements greatly improve the robustness of end systems using this device compared to systems using relays without the integrated current limit. In addition, the active current limit circuitry enables the CPC1540 to pass FCC 68.302 and other regulatory voltage surge requirements when adequate overvoltage protection is provided. The CPC1540 relay may be used in both AC and DC applications.

Approvals

- UL Certified Component: File E76270
- CSA Certified Component: Certificate 1172007
- EN/IEC 60950-1 Certified Component: Certificate available on our website

Ordering Information

Part #	Description
CPC1540G	6-Pin DIP (50/Tube)
CPC1540GS	6-Pin Surface Mount (50/Tube)
CPC1540GSTR	6-Pin Surface Mount, Tape & Reel (1000/Reel)

Switching Characteristics of Normally Open Devices

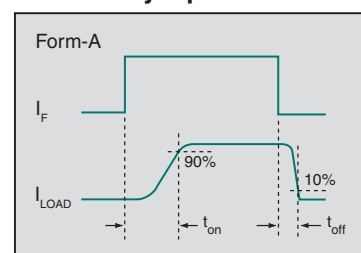

Absolute Maximum Ratings @ 25°C

Parameter	Ratings	Units
Blocking Voltage	350	V _P
Reverse Input Voltage	5	V
Input Control Current	50	mA
Peak (10ms)	1	A
Input Power Dissipation ¹	150	mW
Total Power Dissipation ²	800	mW
Isolation Voltage, Input to Output (60 Seconds)	3750	V _{rms}
Operational Temperature	-40 to +85	°C
Storage Temperature	-40 to +125	°C

¹ Derate linearly 3.33 mW / °C

² Derate linearly 6.67 mW / °C

Absolute Maximum Ratings are stress ratings. Stresses in excess of these ratings can cause permanent damage to the device. Functional operation of the device at conditions beyond those indicated in the operational sections of this data sheet is not implied.

Typical values are characteristic of the device at +25°C, and are the result of engineering evaluations. They are provided for information purposes only, and are not part of the manufacturing testing requirements.

Recommended Operating Conditions

Parameter	Symbol	Configuration	Min	Nominal	Max	Units
Load Current, Continuous	I _L	AC/DC	-	-	120	mA _{rms} / mA _{DC}
		DC-Only	-	-	250	mA _{DC}
Input Control Current	I _F	-	3	5	10	mA
Operating Temperature	-	-	-40	-	+85	°C

Electrical Characteristics @ 25°C

Parameter	Conditions	Symbol	Min	Typ	Max	Units
Output Characteristics						
Current Limit						
AC/DC Configuration	I _F =5mA, V _L =13V, t=5ms	I _{LMT}	190	225	285	mA
DC Configuration	I _F =5mA, V _L =6.5V, t=5ms		360	430	570	
On-Resistance						
AC/DC Configuration	I _F =5mA, I _L =120mA	R _{ON}	12	18.2	25	Ω
DC Configuration	I _F =5mA, I _L =220mA		3	4.2	6.75	
Off-State Leakage Current	V _L =350V	I _{LEAK}	-	-	1	μA
Switching Speeds						
Turn-On	I _F =5mA, I _L =100mA	t _{on}	-	0.72	2	ms
Turn-Off		t _{off}	-	0.3		
Output Capacitance	I _F =0mA, V _L =20V, f=1MHz	C _O	-	14	-	pF
Input Characteristics						
Input Control Current to Activate	I _L =100mA	I _F	-	0.8	2	mA
Input Control Current to Deactivate	I _L <1μA	I _F	0.2	0.6	-	mA
LED Forward Voltage	I _F =5mA	V _F	0.9	1.24	1.5	V
Reverse Input Current	V _{IN} = -5V	I _R	-	-	10	μA
Common Characteristics						
Input to Output Capacitance	V _{IO} =0V, f=1MHz	C _{IO}	-	0.5	-	pF

PERFORMANCE DATA*

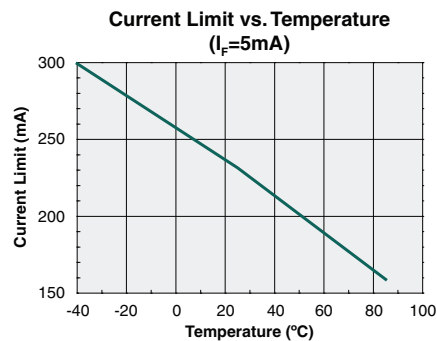
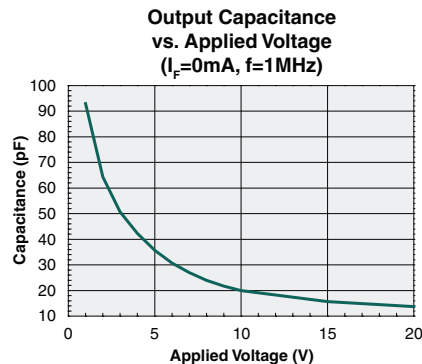
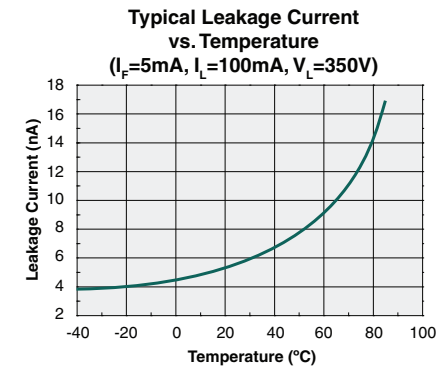
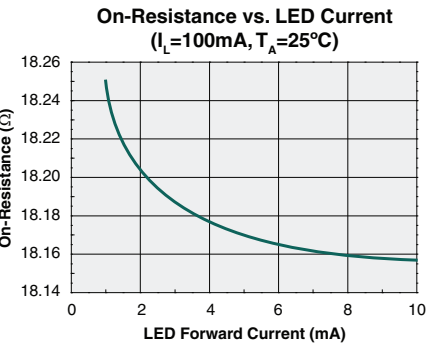
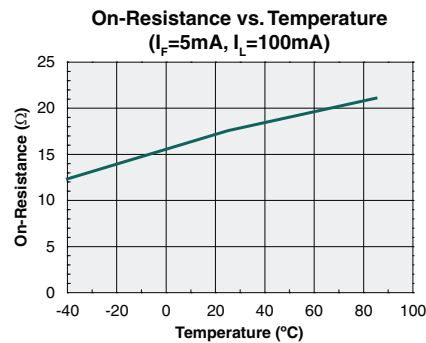
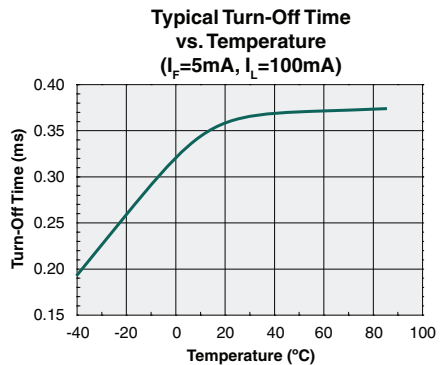
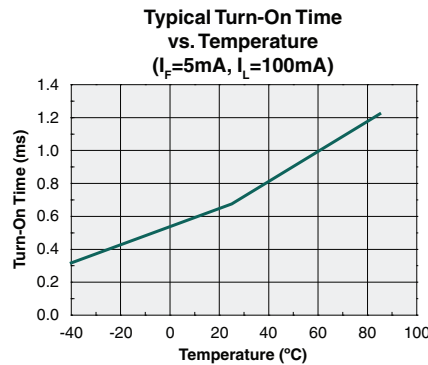
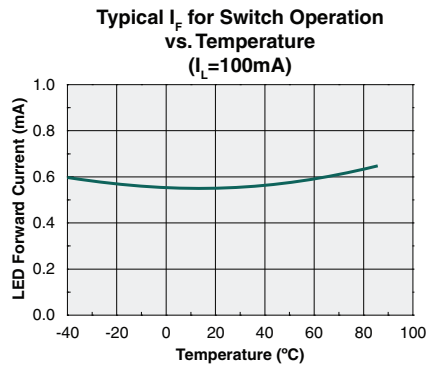
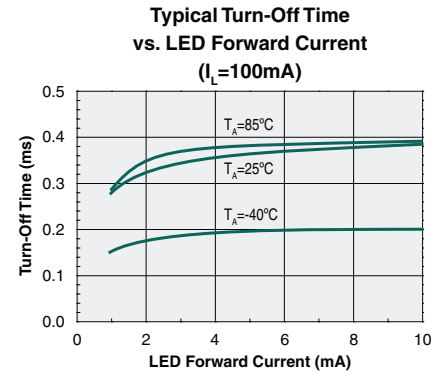
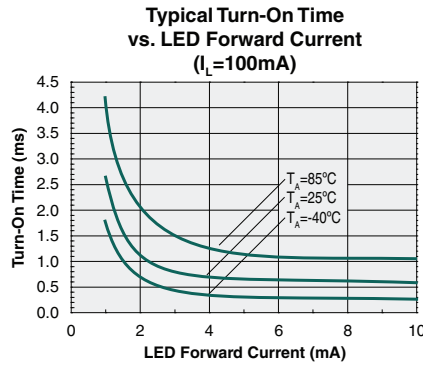
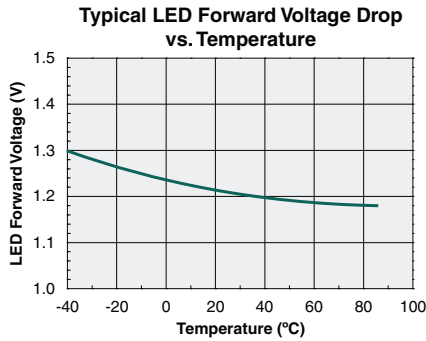

*Unless otherwise noted, data presented in these graphs is typical of device operation at 25°C. For guaranteed parameters not indicated in the written specifications, please contact our application department.

Manufacturing Information

Moisture Sensitivity



All plastic encapsulated semiconductor packages are susceptible to moisture ingress. IXYS Integrated Circuits classifies its plastic encapsulated devices for moisture sensitivity according to the latest version of the joint industry standard, **IPC/JEDEC J-STD-020**, in force at the time of product evaluation. We test all of our products to the maximum conditions set forth in the standard, and guarantee proper operation of our devices when handled according to the limitations and information in that standard as well as to any limitations set forth in the information or standards referenced below.

Failure to adhere to the warnings or limitations as established by the listed specifications could result in reduced product performance, reduction of operable life, and/or reduction of overall reliability.

This product carries a Moisture Sensitivity Level (MSL) classification as shown below, and should be handled according to the requirements of the latest version of the joint industry standard **IPC/JEDEC J-STD-033**.

Device	Moisture Sensitivity Level (MSL) Classification
CPC1540G / CPC1540GS	MSL 1

ESD Sensitivity



This product is **ESD Sensitive**, and should be handled according to the industry standard **JESD-625**.

Soldering Profile

Provided in the table below is the Classification Temperature (T_C) of this product and the maximum dwell time the body temperature of this device may be ($T_C - 5$)°C or greater. The classification temperature sets the Maximum Body Temperature allowed for this device during lead-free reflow processes. For through-hole devices, and any other processes, the guidelines of **J-STD-020** must be observed.

Device	Classification Temperature (T_C)	Dwell Time (t_p)	Max Reflow Cycles
CPC1540G	250°C	30 seconds	1
CPC1540GS	250°C	30 seconds	3

Board Wash

IXYS Integrated Circuits recommends the use of no-clean flux formulations. Board washing to reduce or remove flux residue following the solder reflow process is acceptable provided proper precautions are taken to prevent damage to the device. These precautions include, but are not limited to: using a low pressure wash and providing a follow up bake cycle sufficient to remove any moisture trapped within the device due to the washing process. Due to the variability of the wash parameters used to clean the board, determination of the bake temperature and duration necessary to remove the moisture trapped within the package is the responsibility of the user (assembler). Cleaning or drying methods that employ ultrasonic energy may damage the device and should not be used. Additionally, the device must not be exposed to flux or solvents that are Chlorine- or Fluorine-based.



MECHANICAL DIMENSIONS

CPC1540G

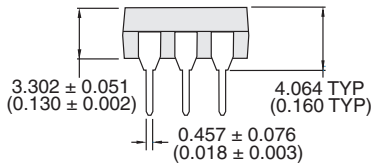
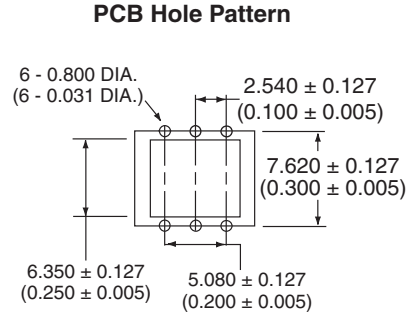
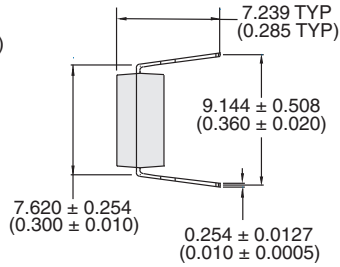
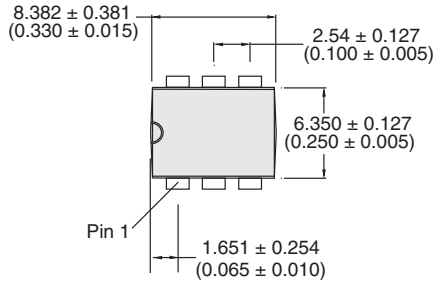

Dimensions
mm
(inches)

CPC1540GS

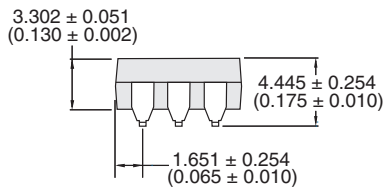
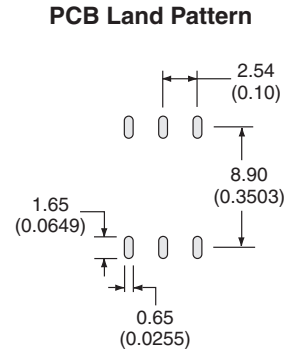
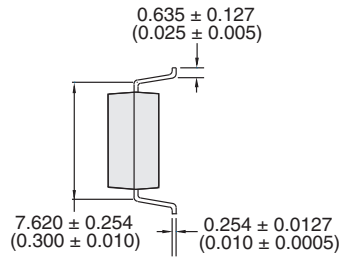
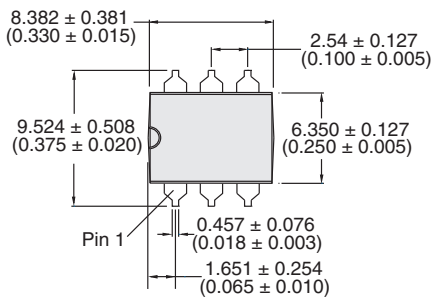

Dimensions
mm
(inches)

MECHANICAL DIMENSIONS

CPC1540GSTR Tape & Reel

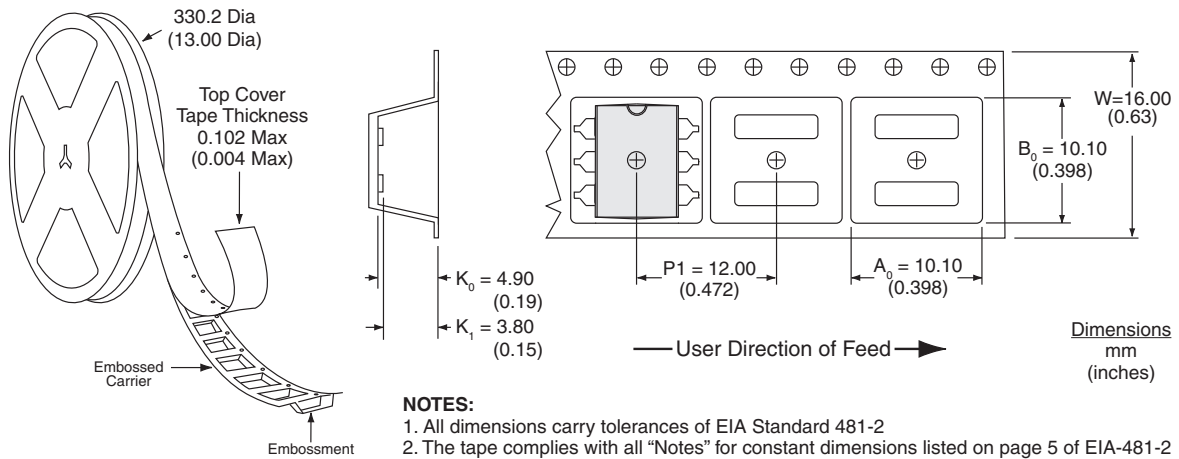

For additional information please visit our website at: www.ixysic.com

IXYS Integrated Circuits makes no representations or warranties with respect to the accuracy or completeness of the contents of this publication and reserves the right to make changes to specifications and product descriptions at any time without notice. Neither circuit patent licenses nor indemnity are expressed or implied. Except as set forth in IXYS Integrated Circuits' Standard Terms and Conditions of Sale, IXYS Integrated Circuits assumes no liability whatsoever, and disclaims any express or implied warranty, relating to its products including, but not limited to, the implied warranty of merchantability, fitness for a particular purpose, or infringement of any intellectual property right.

The products described in this document are not designed, intended, authorized or warranted for use as components in systems intended for surgical implant into the body, or in other applications intended to support or sustain life, or where malfunction of IXYS Integrated Circuits' product may result in direct physical harm, injury, or death to a person or severe property or environmental damage. IXYS Integrated Circuits reserves the right to discontinue or make changes to its products at any time without notice.

The information below supercedes any previously presented material.

For additional information please visit our website at: <https://www.littelfuse.com>



Disclaimer Notice - Information furnished is believed to be accurate and reliable. However, users should independently evaluate the suitability of and test each product selected for their own applications. Littelfuse products are not designed for, and may not be used in, all applications. Read complete Disclaimer Notice at www.littelfuse.com/disclaimer-electronics.