



Parameter	Rating	Units
AC Operating Voltage	20 - 240	V_{rms}
Load Current	3	A_{rms}
On-State Voltage Drop	0.8	V_{rms} (at $I_L = 3A_{rms}$)
Blocking Voltage	800	V_P

Features

- Load Current up to $3A_{rms}$
- $800V_P$ Blocking Voltage
- 5mA Sensitivity
- $5000V_{rms}$ Input to Output Isolation
- Off-State dV/dt : $1000V/\mu s$ Minimum
- 12.5mm External Creepage Distance with Appropriate Layout
- Zero-Cross Switching
- DC Control, AC Output
- Optically Isolated
- TTL and CMOS Compatible
- Low EMI and RFI Generation
- High Noise Immunity

Applications

- Programmable Control
- Process Control
- Power Control Panels
- Remote Switching
- Gas Pump Electronics
- Contactors
- Large Relays
- Solenoids
- Motors
- Heaters

Description

CPC1966B is an AC Solid State Switch utilizing dual power SCR outputs. This device also includes zero-cross turn-on circuitry and is specified with a blocking voltage of $800V_P$.

In addition, the tightly controlled zero-cross circuitry ensures low noise switching of AC loads by minimizing the generation of transients. The optically coupled input and output circuits provide $5000V_{rms}$ of isolation and noise immunity between the control and load circuits. As a result, the CPC1966B is well suited for industrial environments where electromagnetic interference would disrupt the operation of plant facility communication and control systems.

Approvals

- UL 508 Certified Component: File E69938
- CSA Industrial Control Switches Approval: Pending

Ordering Information

Part #	Description
CPC1966B	8-Pin Power SOIC (25/Tube)

Pin Configuration

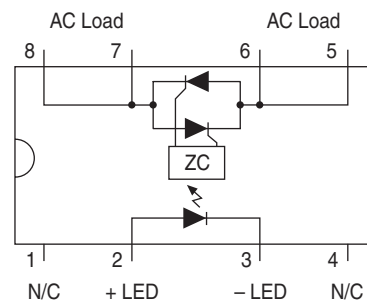

Absolute Maximum Ratings @ 25°C

Parameter	Ratings	Units
Blocking Voltage (V_{DRM})	800	V_P
Reverse Input Voltage	5	V
Input Control Current	50	mA
Peak (10ms)	1	A
Input Power Dissipation ¹	150	mW
Total Power Dissipation ²	2400	mW
Isolation Voltage Input to Output	5000	V_{rms}
ESD, Human Body Model	8	kV
Operational Temperature	-40 to +85	°C
Storage Temperature	-40 to +125	°C

¹ Derate linearly 1.33 mW / °C

² Derate linearly 20 mW / °C

Absolute Maximum Ratings are stress ratings. Stresses in excess of these ratings can cause permanent damage to the device. Functional operation of the device at conditions beyond those indicated in the operational sections of this data sheet is not implied.

Electrical Characteristics @ 25°C

Parameters	Conditions	Symbol	Min	Typ	Max	Units
Output Characteristics						
Load Current, Continuous	$V_L=120-240V_{rms}$	I_L	0.1	-	3	A_{rms}
Maximum Surge Current	$t \leq 16ms$	I_P	-	-	30	A_P
Off State Leakage Current	V_{DRM}	I_{LEAK}	-	-	100	μA_P
On-State Voltage Drop ¹	$I_L=2A_P$	-	-	0.88	1.1	V_P
Off-State dV/dt	$I_F=0mA$	dV/dt	1000	-	-	V/ μs
Switching Speeds	$I_F = 5 mA$	t_{on}	-	-	0.5	cycles
Turn-on						
Turn-off	1st half cycle	-	-	5	20	V
Zero-Cross Turn-On Voltage ²						
Holding Current	-	I_H	-	44	50	mA
Latching Current	-	I_L	-	48	75	mA
Operating Frequency	-	-	20	-	500	Hz
Load Power Factor for Guaranteed Turn-On ³	60Hz	PF	0.25	-	-	-
Input Characteristics						
Input Control Current ⁴	f=60Hz, $I_L=1A$ Resistive	I_F	-	-	5	mA
Input Drop-out Voltage	-	-	0.8	-	-	V
Input Voltage Drop	$I_F=5mA$	V_F	0.9	1.2	1.4	V
Reverse Input Current	$V_R=5V$	I_R	-	-	10	μA
Common Characteristics						
Input to Output Capacitance	-	$C_{i/O}$	-	-	3	pF

¹ Tested at a peak value equivalent.

² Zero Cross 1st half cycle @ <100Hz.

³ Snubber circuits may be required at low power factors.

⁴ For high-noise environments, or for high-frequency operation, use $I_F \geq 10mA$.

Performance Data (@ 25°C Unless Otherwise Noted) *

LED Forward Voltage Distribution
(N=50, $I_F=5\text{mA}$)

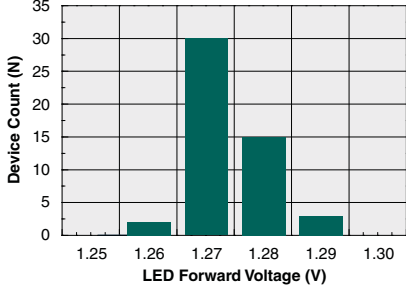

LED Current to Operate Distribution
(60Hz Resistive Load)
(N=50, $V_L=120V_{AC}$)

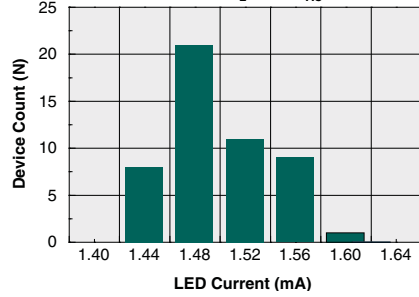

Zero Cross Voltage Distribution
(N=50, $I_F=5\text{mA}$)

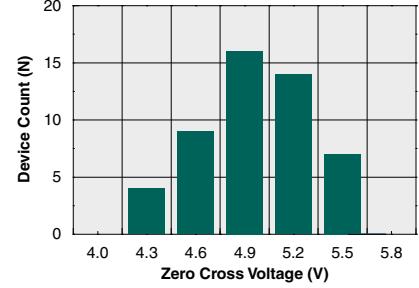

Typical SCR Forward Voltage Distribution
(N=50, $I_F=5\text{mA}$, $I_L=2\text{A}$)

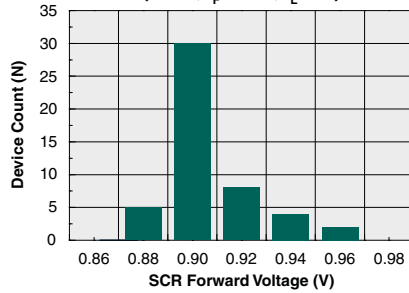

Typical Blocking Voltage Distribution
(N=50)

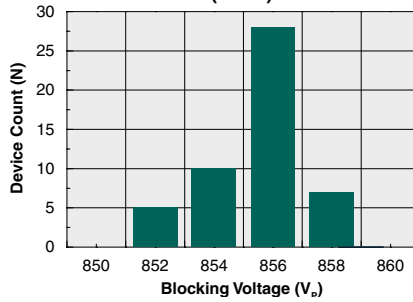

LED Forward Voltage vs. Temperature

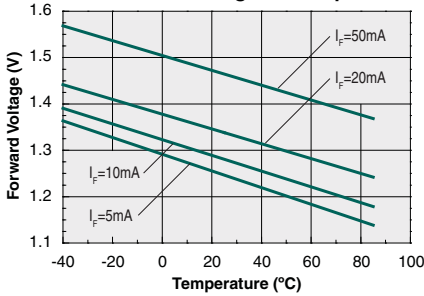

LED Current to Operate vs. Load Frequency
($V_L=140V_{rms}$, $R_L=400\Omega$)

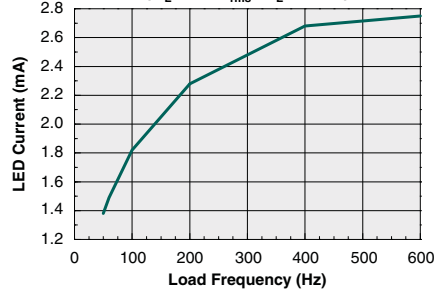

LED Current to Operate
($f_o=60\text{Hz}$)

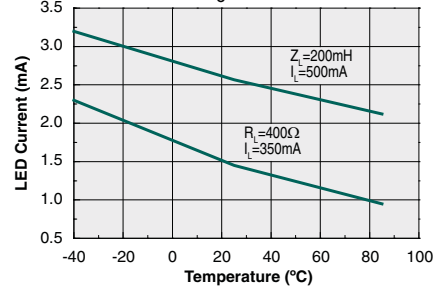

* The Performance data shown in the graphs above is typical of device performance. For guaranteed parameters not indicated in the written specifications, please contact our application department.

Performance Data (@ 25°C Unless Otherwise Noted) *

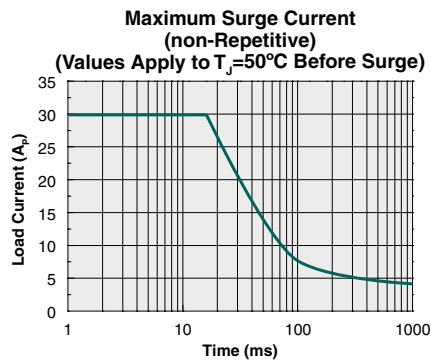
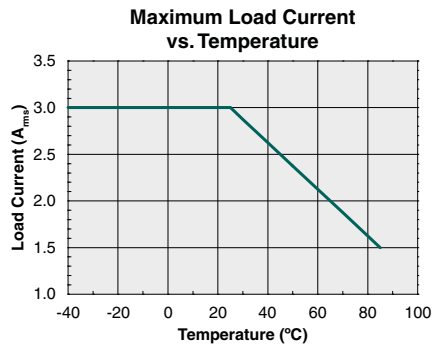
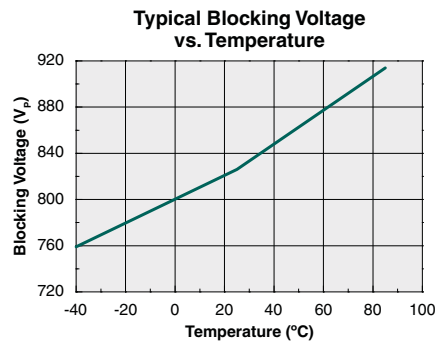
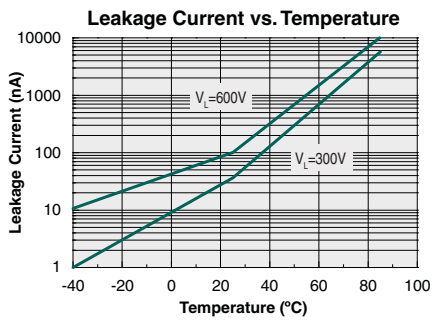
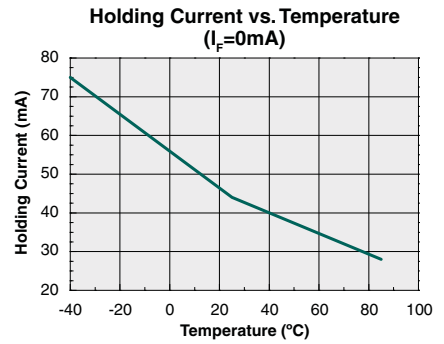
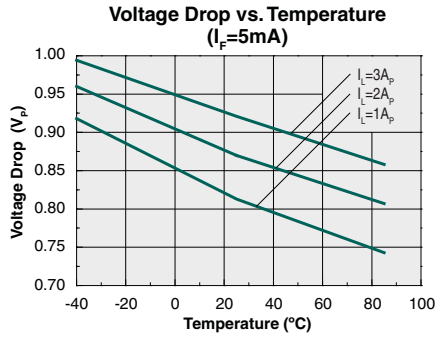
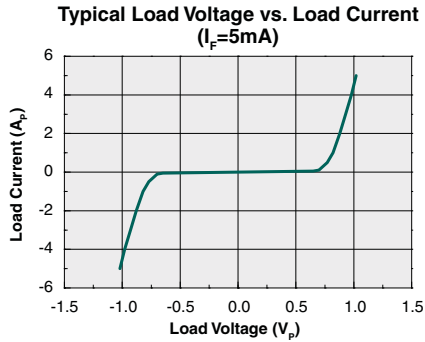

* The Performance data shown in the graphs above is typical of device performance. For guaranteed parameters not indicated in the written specifications, please contact our application department.

Manufacturing Information

Moisture Sensitivity



All plastic encapsulated semiconductor packages are susceptible to moisture ingress. IXYS Integrated Circuits Division classified all of its plastic encapsulated devices for moisture sensitivity according to the latest version of the joint industry standard, **IPC/JEDEC J-STD-020**, in force at the time of product evaluation. We test all of our products to the maximum conditions set forth in the standard, and guarantee proper operation of our devices when handled according to the limitations and information in that standard as well as to any limitations set forth in the information or standards referenced below.

Failure to adhere to the warnings or limitations as established by the listed specifications could result in reduced product performance, reduction of operable life, and/or reduction of overall reliability.

This product carries a **Moisture Sensitivity Level (MSL) rating** as shown below, and should be handled according to the requirements of the latest version of the joint industry standard **IPC/JEDEC J-STD-033**.

Device	Moisture Sensitivity Level (MSL) Rating
CPC1966B	MSL 1

ESD Sensitivity



This product is **ESD Sensitive**, and should be handled according to the industry standard **JESD-625**.

Reflow Profile

This product has a maximum body temperature and time rating as shown below. All other guidelines of **J-STD-020** must be observed.

Device	Maximum Temperature x Time
CPC1966B	245°C for 30 seconds

Board Wash

IXYS Integrated Circuits Division recommends the use of no-clean flux formulations. However, board washing to remove flux residue is acceptable. Since IXYS Integrated Circuits Division employs the use of silicone coating as an optical waveguide in many of its optically isolated products, the use of a short drying bake could be necessary if a wash is used after solder reflow processes. Chlorine- or Fluorine-based solvents or fluxes should not be used. Cleaning methods that employ ultrasonic energy should not be used.



MECHANICAL DIMENSIONS

CPC1966B

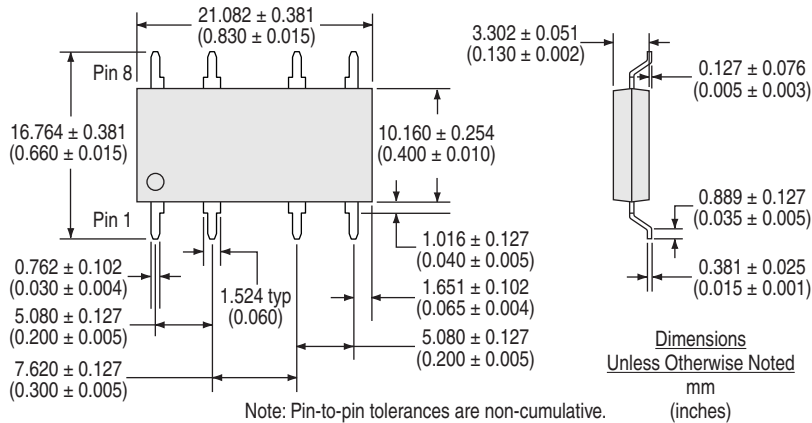

Recommended PCB Pattern

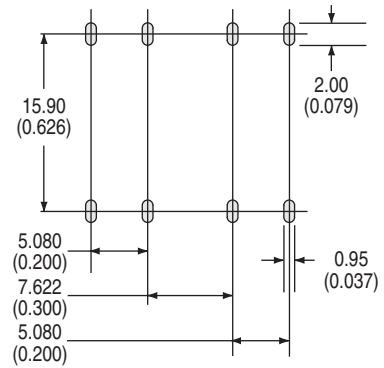

For additional information please visit our website at: www.ixysic.com

IXYS Integrated Circuits Division makes no representations or warranties with respect to the accuracy or completeness of the contents of this publication and reserves the right to make changes to specifications and product descriptions at any time without notice. Neither circuit patent licenses nor indemnity are expressed or implied. Except as set forth in IXYS Integrated Circuits Division's Standard Terms and Conditions of Sale, IXYS Integrated Circuits Division assumes no liability whatsoever, and disclaims any express or implied warranty, relating to its products including, but not limited to, the implied warranty of merchantability, fitness for a particular purpose, or infringement of any intellectual property right.

The products described in this document are not designed, intended, authorized or warranted for use as components in systems intended for surgical implant into the body, or in other applications intended to support or sustain life, or where malfunction of IXYS Integrated Circuits Division's product may result in direct physical harm, injury, or death to a person or severe property or environmental damage. IXYS Integrated Circuits Division reserves the right to discontinue or make changes to its products at any time without notice.

The information below supercedes any previously presented material.

For additional information please visit our website at: <https://www.littelfuse.com>



Disclaimer Notice - Information furnished is believed to be accurate and reliable. However, users should independently evaluate the suitability of and test each product selected for their own applications. Littelfuse products are not designed for, and may not be used in, all applications. Read complete Disclaimer Notice at www.littelfuse.com/disclaimer-electronics.