

Characteristics

Parameter	Rating	Units
AC Operating Voltage	20-280	V_{AC} (V_{rms})
Load Current		A_{rms}
With 5°C/W Heat Sink	20	
No Heat Sink	5	
On-State Voltage Drop	1.1	V_P (at $I_L=2A_P$)
Blocking Voltage	800	V_P
Thermal Impedance, Junction-to-Case, θ_{JC}	0.35	°C/W

Features

- Load Current up to $20A_{rms}$ with 5°C/W Heat Sink
- 800V_P Blocking Voltage
 - Creepage Pin 1 to Pin 2 of 0.225 inch (5.715 mm)
- 5mA Control Current
- Zero-Cross Switching
- 2500V_{rms} Isolation, Input to Output
 - Creepage Pin 2 to Pin 3 of 0.375 inch (9.525 mm)
- DC Control, AC Output
- Optically Isolated
- Low EMI and RFI Generation
- High Noise Immunity
- Flammability Rating UL 94 V-0

Applications

- Lighting
 - Tungsten Load: 4.75A (Free Air), 15A (Heat Sink)
 - Electrical Ballast: 5A (Free Air), 15A (Heat Sink)
- Programmable Control
- Process Control
- Power Control Panels
- Remote Switching
- Gas Pump Electronics
- Contactors
- Large Relays
- Solenoids
- Motors: 1/3HP (Free Air), 1/2HP (Heat Sink)
- Heaters

Approvals

- UL 508 Recognized Component: File E69938
See “UL Approved Ratings” on page 4.



Description

CPC40055ST is an AC Solid State Switch utilizing dual power SCR outputs. This device includes zero-cross turn-on circuitry and is specified with an 800V_P blocking voltage.

Tightly controlled zero-cross circuitry ensures low noise switching of AC loads by minimizing the generation of transients. The optically coupled input and output circuits provide exceptional noise immunity and 2500V_{rms} of isolation. As a result, the CPC40055ST is well suited for industrial environments where electromagnetic interference would disrupt the operation of communications and control systems.

The unique SuperSIP package pioneered by IXYS Integrated Circuits allows Solid State Relays to achieve the highest load current currently available in any similar-sized package. This package features a unique process in which the silicon chips are soft soldered onto the ceramic Direct Copper Bond (DCB) substrate instead of the traditional copper leadframe. The DCB ceramic, the same substrate used in high power modules, not only provides 2500V_{rms} isolation but also very low junction-to-case thermal impedance (0.35 °C/W).

Ordering Information

Part	Description
CPC40055ST	SuperSIP Package (13 per tube)

Pin Configuration & Waveforms

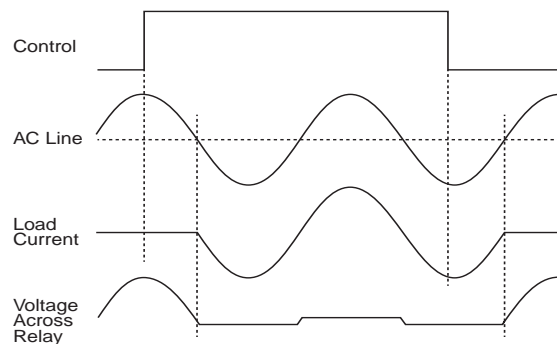
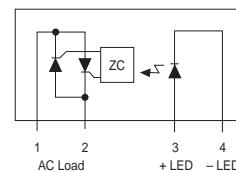

1 .Specifications

1.1 Absolute Maximum Ratings @ 25°C

Symbol	Min	Max	Units
Blocking Voltage	-	800	V _P
Reverse Input Voltage	-	5	V
Input Control Current	-	50	mA
Peak (10ms)	-	1	A
Input Power Dissipation ¹	-	150	mW
Total Power Dissipation ²	-	4.4	W
I ² t for Fusing (1/2 Sine Wave, 60Hz)	-	200	A ² s
Isolation Voltage, Input to Output 60 Seconds	-	2500	V _{rms}
ESD, Human Body Model	-	4	kV
Junction Temperature (T _J)	-	150	°C
Operational Temperature	-40	+85	°C
Storage Temperature	-40	+125	°C

¹ Derate linearly 1.33mW / °C.

² Free air, no heat sink.

Absolute maximum ratings are stress ratings. Stresses in excess of these ratings can cause permanent damage to the device. Functional operation of the device at conditions beyond those indicated in the operational sections of this data sheet is not implied.

Typical values are characteristic of the device at +25°C, and are the result of engineering evaluations. They are provided for information purposes only, and are not part of the manufacturing testing requirements.

1.2 Electrical Characteristics @ 25°C

Parameter	Conditions	Symbol	Minimum	Typical	Maximum	Units
Output Characteristics						
Load Current	No Heat Sink, V _L =20-280V _{rms} T _C =25°C	I _L	0.1	-	5	A _{rms}
Continuous			0.1	-	40	
Maximum Surge Current	1/2 Sine Wave, 60Hz	I _P	-	-	150	A
Off-State Leakage Current	V _L =800V	I _{LEAK}	-	-	100	μA _P
On-State Voltage Drop	I _L =2A _P	-	-	0.85	1.1	V _P
Off-State dV/dt	I _F =0mA	dV/dt	1000	-	-	V/μs
Switching Speeds	I _F =5mA	t _{on}	-	-	0.5	cycles
Turn-On		t _{off}	-	-	0.5	
Turn-Off						
Zero-Cross Turn-On Voltage ¹	1 st half-cycle	-	-	6.8	20	V
	subsequent half-cycle	-	-	-	5	
Holding Current	-	I _H	-	-	50	mA
Latching Current	-	I _L	-	-	75	mA
Operating Frequency	-	-	20	-	500	Hz
Load Power Factor for Guaranteed Turn-On ²	f=60Hz	PF	0.25	-	-	-
Input Characteristics						
LED Current to Activate ³	I _L =1A Resistive, f=60Hz	I _F	-	-	5	mA
Input Voltage to Deactivate	-	-	0.8	-	-	V
Input Voltage Drop	I _F =5mA	V _F	0.9	1.2	1.5	V
Reverse Input Current	V _R =5V	I _R	-	-	10	μA
Input/Output Characteristics						
Capacitance, Input-to-Output	V _{IO} =0V, f=1MHz	C _{IO}	-	-	3	pF

¹ Zero-cross first half-cycle @ < 100Hz.

² Snubber circuits may be required at low power factors.

³ For high-noise environments, or high-frequency operation (>60Hz), or for applications with a high inductive load, a minimum LED drive current of 10mA is recommended.

2 Thermal Characteristics

Parameter	Conditions	Symbol	Rating	Units
Thermal Impedance (Junction to Case)	-	θ_{JC}	0.35	$^{\circ}\text{C}/\text{W}$
Thermal Impedance (Junction to Ambient)	Free Air	θ_{JA}	27	$^{\circ}\text{C}/\text{W}$
Junction Temperature (Operating)	-	T_J	-40 to +150	$^{\circ}\text{C}$

2.1 Heat Sink Calculation

Higher load currents are possible by using lower thermal impedance heat sink combinations.

Heat Sink Rating

$$\theta_{CA} = \frac{(T_J - T_A)}{P_D} - \theta_{JC}$$

T_J = Junction Temperature ($^{\circ}\text{C}$), $T_J \leq 150^{\circ}\text{C}$ *

T_A = Ambient Temperature ($^{\circ}\text{C}$)

θ_{JC} = Thermal Impedance, Junction to Case ($^{\circ}\text{C}/\text{W}$) = $0.35^{\circ}\text{C}/\text{W}$

θ_{CA} = Thermal Impedance of Heat Sink & Thermal Interface Material, Case to Ambient ($^{\circ}\text{C}/\text{W}$)

P_D = On-State Voltage (V_{rms}) • Load Current (A_{rms})

* Elevated junction temperature reduces semiconductor lifetime.

NOTE: The exposed surface of the DCB substrate is not to be soldered.

2.2 Thermal Performance Data

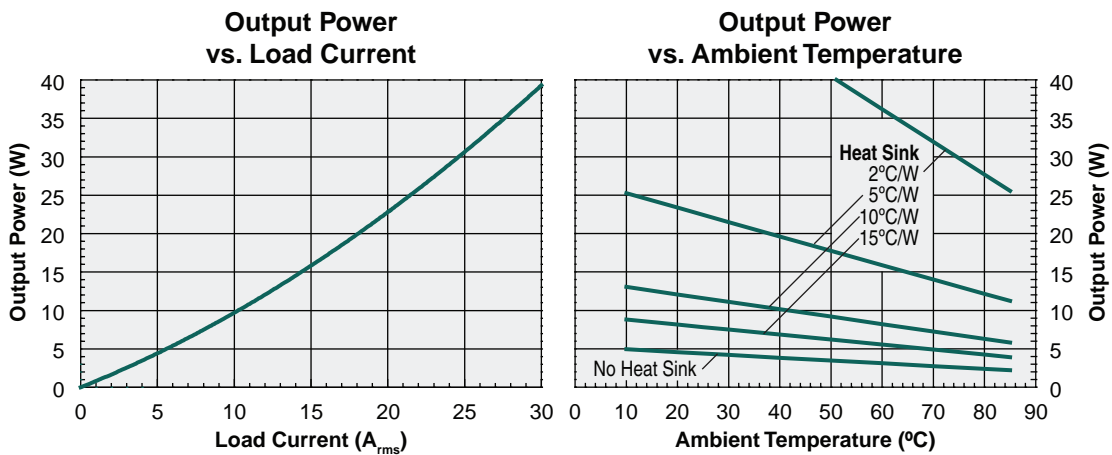

3 UL Approved Ratings

3.1 General Loads

Voltage (V _{AC})	Current (A)	Surrounding Air Temperature (°C)
20 - 280	4.75	40
20 - 280	2.5	80
51 - 150	15 (with Heat Sink*)	40
51 - 150	11.75 (with Heat Sink*)	65

3.2 Tungsten Lamp Load

Voltage (V _{AC})	Current (A)	Surrounding Air Temperature (°C)
20 - 280	4.75	40
20 - 280	2.5	80
51 - 150	15 (with Heat Sink*)	40
51 - 150	11.75 (with Heat Sink*)	65

3.3 Motor Load

Voltage (V _{AC})	Current	Surrounding Air Temperature (°C)
220 - 240	1/3 HP, 3.6 FLA	40
220 - 240	1/6 HP, 2.2 FLA	80
110 - 120	1/2 HP, 9.8 FLA (with Heat Sink*)	40
110 - 120	1/2 HP, 9.8 FLA (with Heat Sink*)	65

3.4 Electronic Ballast Load

Voltage (V _{AC})	Current (A)	Surrounding Air Temperature (°C)
120	5	30
120	15 (with Heat Sink*)	40
120	10 (with Heat Sink*)	65

Note: *Heat Sink Used for UL Testing: Ohmite MA-302-55E

4 Performance Data*

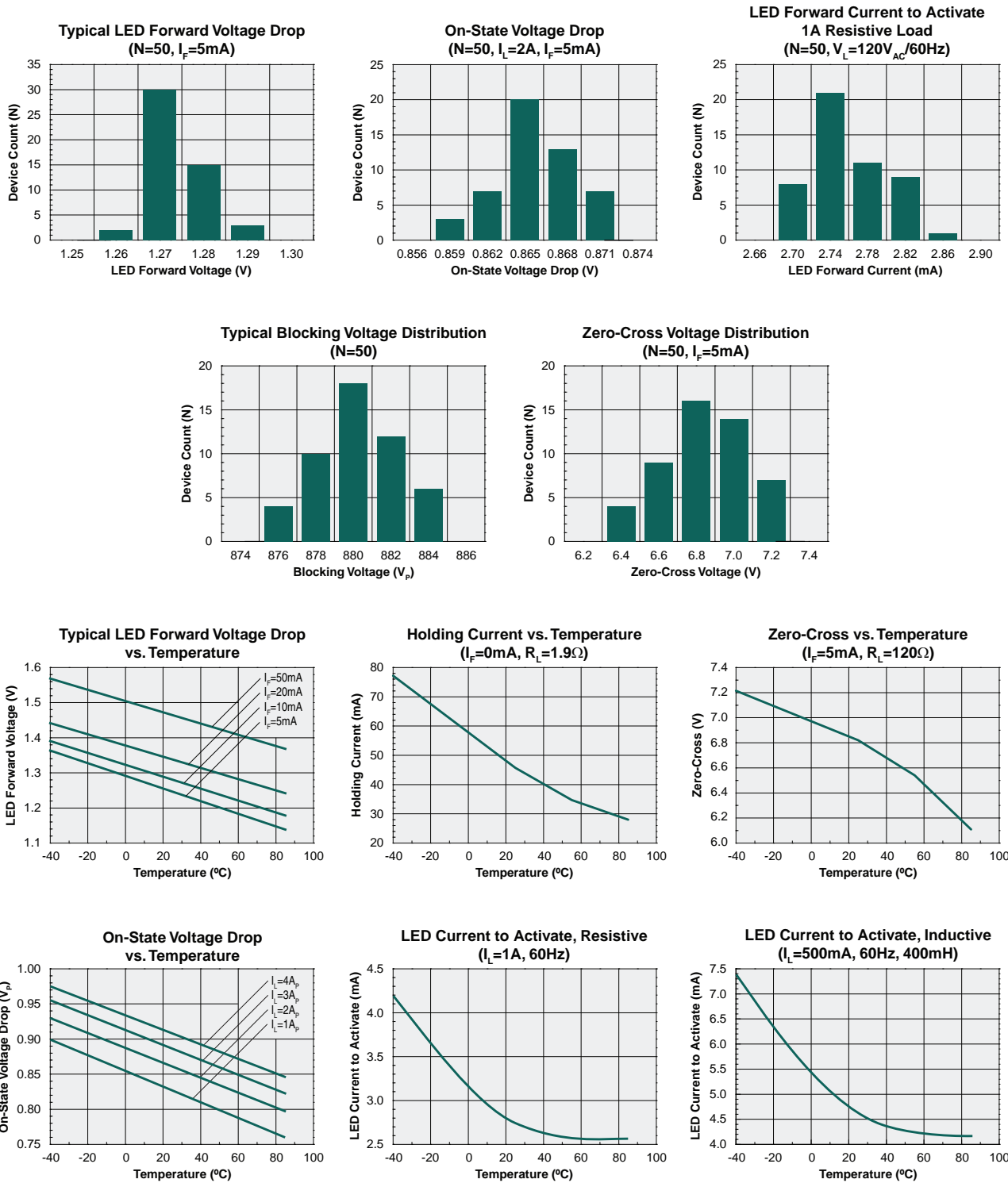

*Unless otherwise noted, data presented in these graphs is typical of device operation at 25°C. For guaranteed parameters not indicated in the written specifications, please contact our application department.

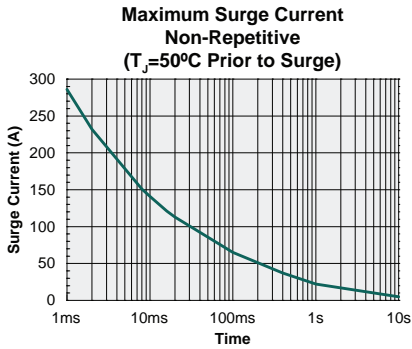
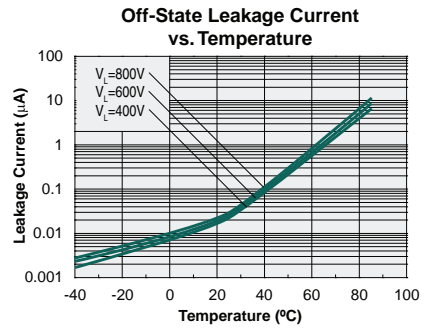
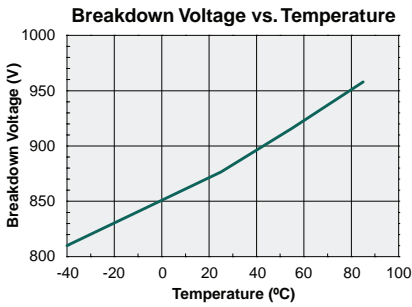
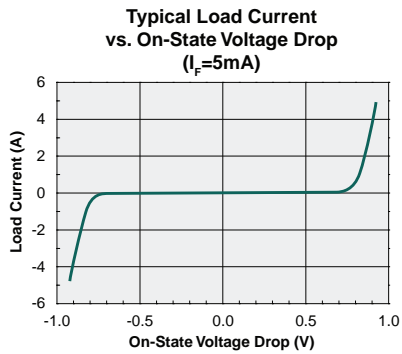
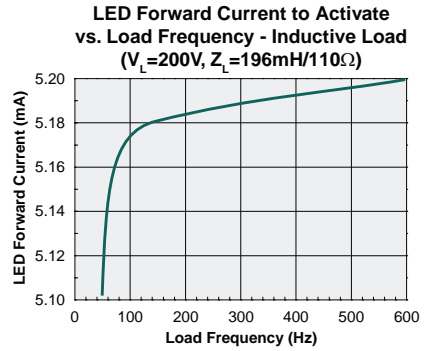
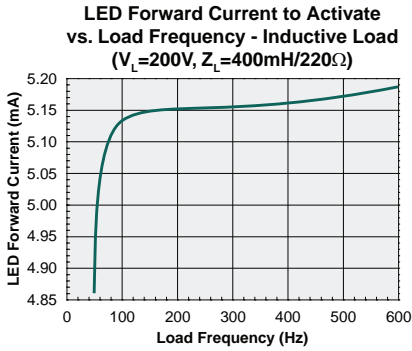
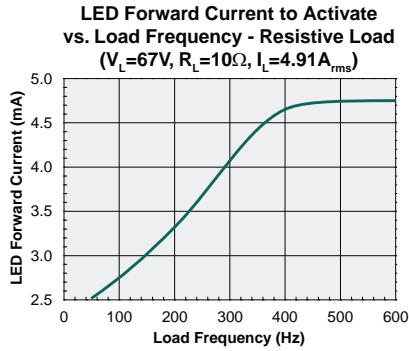

*Unless otherwise noted, data presented in these graphs is typical of device operation at 25°C.
For guaranteed parameters not indicated in the written specifications, please contact our application department.

5 Manufacturing Information

5.1 Moisture Sensitivity



All plastic encapsulated semiconductor packages are susceptible to moisture ingress. IXYS Integrated Circuits classifies its plastic encapsulated devices for moisture sensitivity according to the latest version of the joint industry standard, **IPC/JEDEC J-STD-020**, in force at the time of product evaluation. We test all of our products to the maximum conditions set forth in the standard, and guarantee proper operation of our devices when handled according to the limitations and information in that standard as well as to any limitations set forth in the information or standards referenced below.

Failure to adhere to the warnings or limitations as established by the listed specifications could result in reduced product performance, reduction of operable life, and/or reduction of overall reliability.

This product carries a **Moisture Sensitivity Level (MSL)** classification as shown below, and should be handled according to the requirements of the latest version of the joint industry standard **IPC/JEDEC J-STD-033**.

Device	Moisture Sensitivity Level (MSL) Classification
CPC40055ST	MSL 1

5.2 ESD Sensitivity



This product is **ESD Sensitive**, and should be handled according to the industry standard **JESD-625**.

5.3 Soldering Profile

Provided in the table below is the Classification Temperature (T_C) of this product and the maximum dwell time the body temperature of this device may be ($T_C - 5$)°C or greater. The classification temperature sets the Maximum Body Temperature allowed for this device during lead-free reflow processes. For through-hole devices, and any other processes, the guidelines of **J-STD-020** must be observed.

Device	Classification Temperature (T_C)	Dwell Time (t_p)	Max Reflow Cycles
CPC40055ST	245°C	30 seconds	1

NOTE: The exposed surface of the DCB substrate is not to be soldered.

5.4 Board Wash

IXYS Integrated Circuits recommends the use of no-clean flux formulations. Board washing to reduce or remove flux residue following the solder reflow process is acceptable provided proper precautions are taken to prevent damage to the device. These precautions include but are not limited to: using a low pressure wash and providing a follow up bake cycle sufficient to remove any moisture trapped within the device due to the washing process. Due to the variability of the wash parameters used to clean the board, determination of the bake temperature and duration necessary to remove the moisture trapped within the package is the responsibility of the user (assembler). Cleaning or drying methods that employ ultrasonic energy may damage the device and should not be used. Additionally, the device must not be exposed to flux or solvents that are Chlorine- or Fluorine-based.



5.5 Mechanical Dimensions

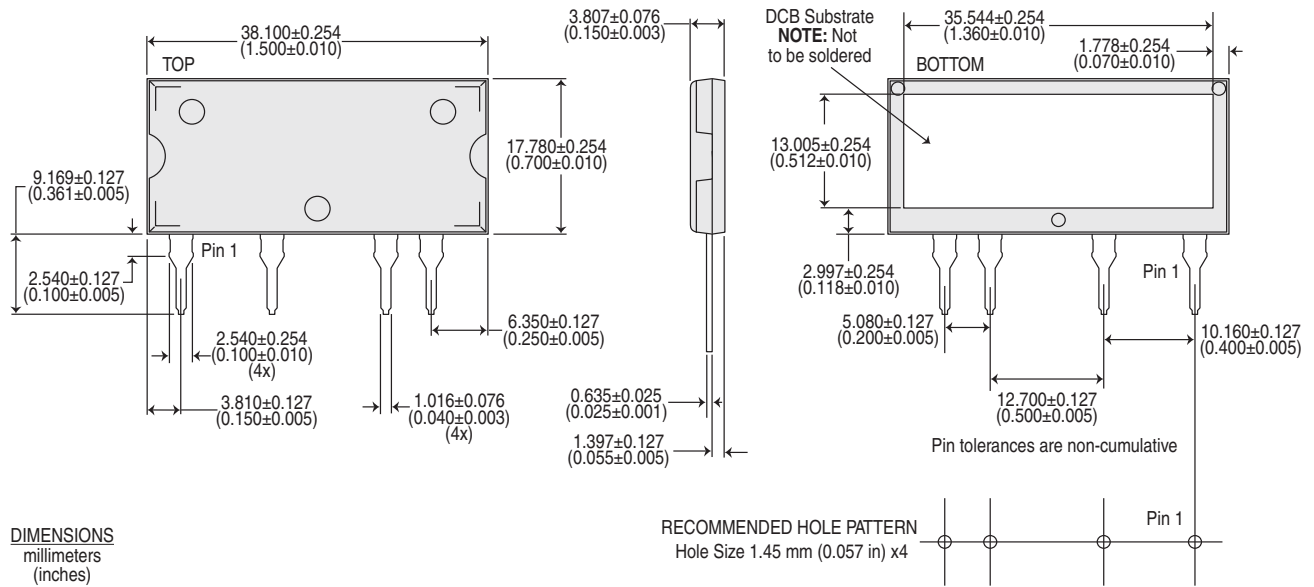

For additional information please visit our website at: www.ixysic.com

IXYS Integrated Circuits makes no representations or warranties with respect to the accuracy or completeness of the contents of this publication and reserves the right to make changes to specifications and product descriptions at any time without notice. Neither circuit patent licenses nor indemnity are expressed or implied. Except as set forth in IXYS Integrated Circuits' Standard Terms and Conditions of Sale, IXYS Integrated Circuits assumes no liability whatsoever, and disclaims any express or implied warranty, relating to its products including, but not limited to, the implied warranty of merchantability, fitness for a particular purpose, or infringement of any intellectual property right.

The products described in this document are not designed, intended, authorized or warranted for use as components in systems intended for surgical implant into the body, or in other applications intended to support or sustain life, or where malfunction of IXYS Integrated Circuits' product may result in direct physical harm, injury, or death to a person or severe property or environmental damage. IXYS Integrated Circuits reserves the right to discontinue or make changes to its products at any time without notice.

Specification: DS-CPC40055ST-R04
©Copyright 2018, IXYS Integrated Circuits
All rights reserved. Printed in USA.
6/29/2018

The information below supercedes any previously presented material.

For additional information please visit our website at: <https://www.littelfuse.com>



Disclaimer Notice - Information furnished is believed to be accurate and reliable. However, users should independently evaluate the suitability of and test each product selected for their own applications. Littelfuse products are not designed for, and may not be used in, all applications. Read complete Disclaimer Notice at www.littelfuse.com/disclaimer-electronics.