

Parameter	Rating	Units
Open Circuit Voltage	12.2	V
Short Circuit Current	9.1	μA

Features

- Dual Independent, Floating Outputs for Parallel, Series, or Isolated Configurations
- 24.4V Open Circuit Voltage in Series Configuration
- 18.2 μA Short Circuit Current in Parallel Configuration
- 5mA Input Control Current
- Integrated Turn-Off Circuitry
- High Input to Output Isolation: 3750V_{rms}
- Replacement of Discrete Components
- No EMI/RFI Generation
- Surface Mount Tape & Reel Version Available
- Flammability Rating UL 94 V-0

Applications

- MOSFET Driver
- Programmable Control
- Process Control
- Instrumentation
- Telecommunications
- Solid State Relays
- Isolated Switching
- Floating Power Supplies

Description

The FDA217 is a dual photovoltaic MOSFET driver. Each independent driver consists of an LED that is optically coupled to a photodiode array.

The driver output is controlled by means of the highly effective infrared LED at the input. When input current is applied to the LED, the emitted light activates the photodiode array, which generates the voltage at the output.

The photodiode array is capable of generating a floating power source with voltage and current sufficient to drive high-power MOSFET transistors. Each photodiode array contains an integrated turn-off circuit that discharges the external MOSFET gate when LED current is removed. This eliminates the need to use external components to facilitate the discharge. The optically coupled technology provides 3750V_{rms} of input to output isolation.

The FDA217 is well suited for use in discrete solid state relay designs and in other isolated switching applications.

Approvals

- EN 62368-1: TUV Certificate # B 082667 0008

Ordering Information

Part #	Description
FDA217	8-Lead DIP (50/tube)
FDA217S	8-Lead Surface Mount (50/tube)
FDA217STR	8-Lead Surface Mount (1000/reel)

Pin Configuration

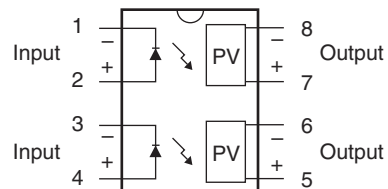

Absolute Maximum Ratings @ 25°C

Parameter	Ratings	Units
Reverse Input Voltage	5	V
Input Control Current	50	mA
Peak (10ms)	1	A
Input Power Dissipation ¹	140	mW
Total Power Dissipation ²	500	mW
ESD Rating, Human Body Model	8	kV
Isolation Voltage, Input to Output	3750	V _{rms}
Operational Temperature, Ambient	-40 to +85	°C
Storage Temperature	-40 to +125	°C

¹ Derate linearly 1.33 mW / °C

² Derate output power linearly 6.67 mW / °C

Absolute Maximum Ratings are stress ratings. Stresses in excess of these ratings can cause permanent damage to the device. Functional operation of the device at conditions beyond those indicated in the operational sections of this data sheet is not implied.

Typical values are characteristic of the device at the specified temperatures and are the result of engineering evaluations. They are provided for information purposes only and are not part of the manufacturing testing requirements.

Electrical Characteristics @ 25°C

Parameter	Conditions	Symbol	Min	Typ	Max	Units
Output Characteristics						
Open Circuit Voltage	I _F =5mA	V _{OC}	10.5	11.75	15.3	V
	I _F =10mA		10.5	12.2	15.3	
Short Circuit Current	I _F =5mA	I _{SC}	2.5	4.5	-	μA
	I _F =10mA		5	9.1		
	I _F =15mA		7.5	13.5		
	I _F =20mA		10	18.5		
	I _F =30mA		15	27		
Switching Speeds	I _F =5mA, V _{LOAD} =5V, C _{LOAD} =200pF	t _{on}	-	-	2	ms
		t _{off}	-	-	0.5	
Offstate Clamping Resistance	V _L =1V	R _{CL}	100	770	3300	Ω
Input Characteristics						
LED Current to Activate	I _{SC} =2.5μA	I _F	-	3.8	5	mA
Input Voltage Drop	I _F =5mA	V _F	0.9	1.36	1.5	V
Reverse Input Current	V _R =5V	I _R	-	-	10	μA
Common Characteristics						
Capacitance, Input to Output	-	C _{IO}	-	3	-	pF

PERFORMANCE DATA

Typical LED Forward Voltage Drop
(N=50, $I_F=5\text{mA}$)

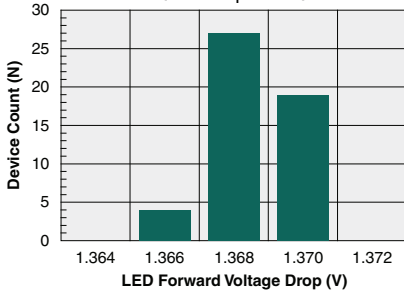

Typical Open-Circuit Voltage
(N=50, $I_F=10\text{mA}$)

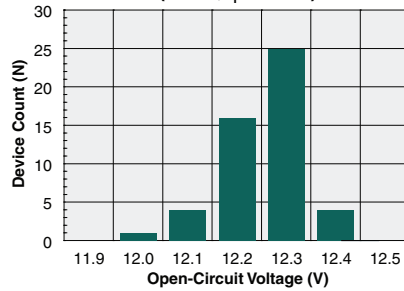

Typical Short-Circuit Current
(N=50, $I_F=10\text{mA}$)

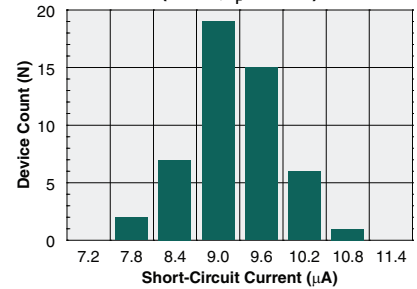

Typical LED Forward Voltage vs. Forward Current

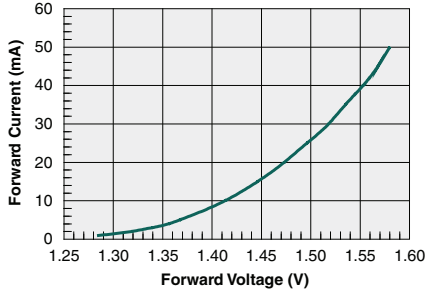

Turn-On Time vs. Load Capacitance
($V_{OUT}=5\text{V}$)

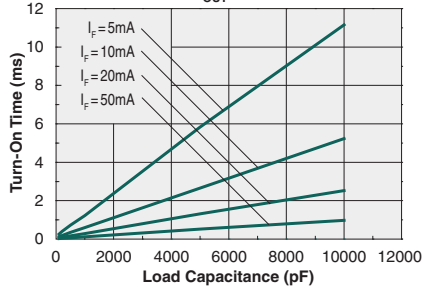

Turn-Off Time vs. Load Capacitance
($V_{OUT}=5\text{V}$)

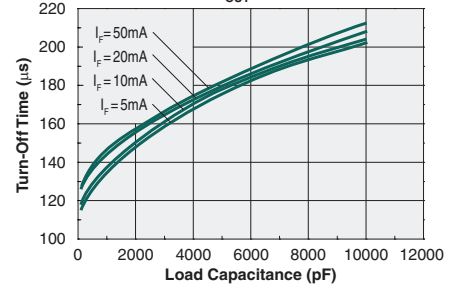

Typical LED Forward Voltage Drop vs. Ambient Temperature

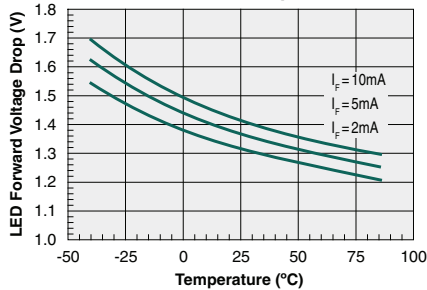

Turn-On Time vs. Ambient Temperature
($V_{out}=5\text{V}$, $C_L=200\text{pF}$)

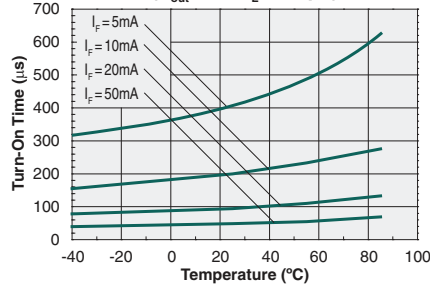

Turn-Off Time vs. Ambient Temperature
($V_{out}=5\text{V}$, $C_L=200\text{pF}$)

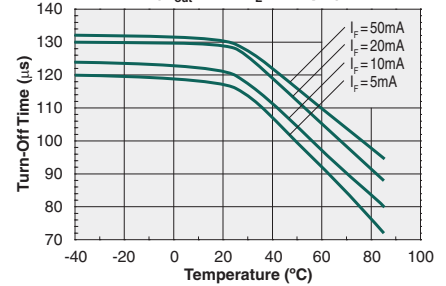

Open-Circuit Voltage vs. Ambient Temperature

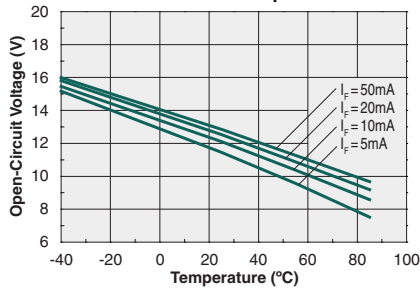

Short-Circuit Current vs. Ambient Temperature

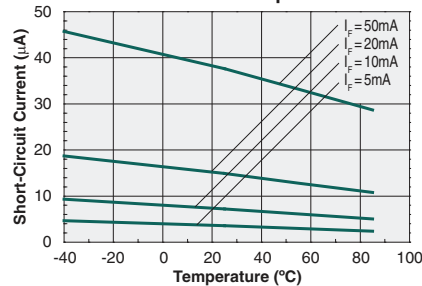

Offstate Clamping Resistance vs. Ambient Temperature
($V_L=1\text{V}$)

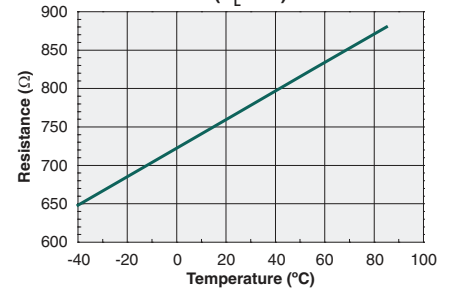

*Unless otherwise noted, data presented in these graphs is typical of device operation at 25°C.

Manufacturing Information

Moisture Sensitivity



All plastic encapsulated semiconductor packages are susceptible to moisture ingress. Littelfuse classifies its plastic encapsulated devices for moisture sensitivity according to the latest version of the joint industry standard, **IPC/JEDEC J-STD-020**, in force at the time of product evaluation. We test all of our products to the maximum conditions set forth in the standard, and guarantee proper operation of our devices when handled according to the limitations and information in that standard as well as to any limitations set forth in the information or standards referenced below.

Failure to adhere to the warnings or limitations as established by the listed specifications could result in reduced product performance, reduction of operable life, and/or reduction of overall reliability.

This product carries a **Moisture Sensitivity Level (MSL)** classification as shown below, and should be handled according to the requirements of the latest version of the joint industry standard **IPC/JEDEC J-STD-033**.

Device	Moisture Sensitivity Level (MSL) Classification
FDA217S	MSL 1

ESD Sensitivity



This product is ESD Sensitive, and should be handled according to the industry standard **JESD-625**.

Soldering Profile

Provided in the table below is the **IPC/JEDEC J-STD-020** Classification Temperature (T_c) and the maximum dwell time (t_p) the body temperature of these surface mount devices may be ($T_c - 5$)°C or greater. The Classification Temperature sets the Maximum Body Temperature allowed for these devices during reflow soldering processes.

Device	Classification Temperature (T_c)	Dwell Time (t_p)	Max Reflow Cycles
FDA217S	250°C	30 seconds	3

For through-hole devices, the wave soldering maximum lead (pin) temperature and the maximum dwell time the leads (pins) are at the peak soldering temperature is given in the table below. Maximum wave soldering parameters are shown below.

Device	Pin Temperature	Body Temperature	Dwell Time	Wave Cycles
FDA217	260°C	250°C	10 seconds	1

Board Wash

Littelfuse recommends the use of no-clean flux formulations. Board washing to reduce or remove flux residue following the solder reflow process is acceptable provided proper precautions are taken to prevent damage to the device. These precautions include but are not limited to: using a low pressure wash and providing a follow up bake cycle sufficient to remove any moisture trapped within the device due to the washing process. Due to the variability of the wash parameters used to clean the board, determination of the bake temperature and duration necessary to remove the moisture trapped within the package is the responsibility of the user (assembler). Cleaning or drying methods that employ ultrasonic energy may damage the device and should not be used. Additionally, the device must not be exposed to halide flux or solvents.



Mechanical Dimensions

FDA217

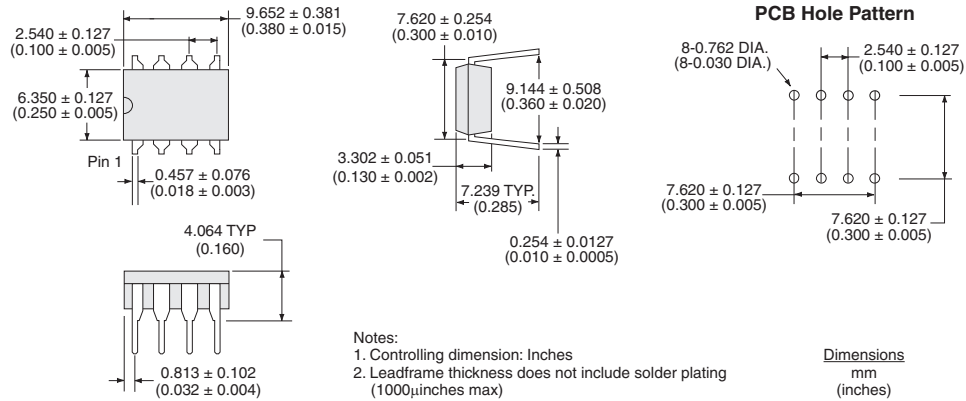

FDA217S

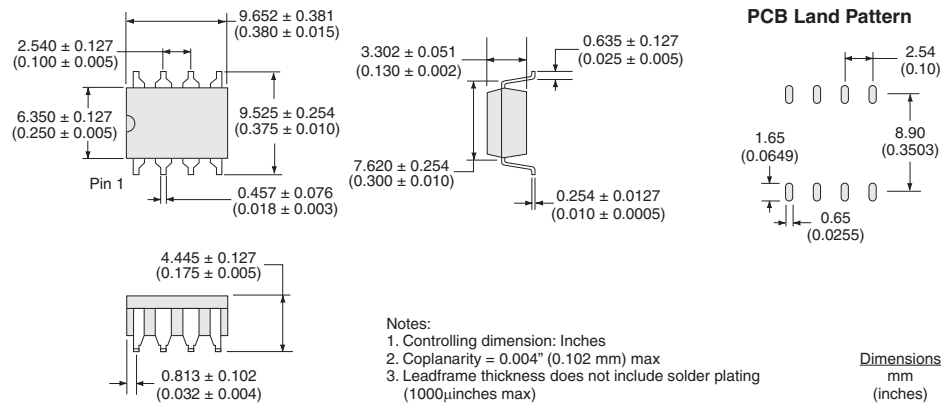

FDA217STR Tape & Reel

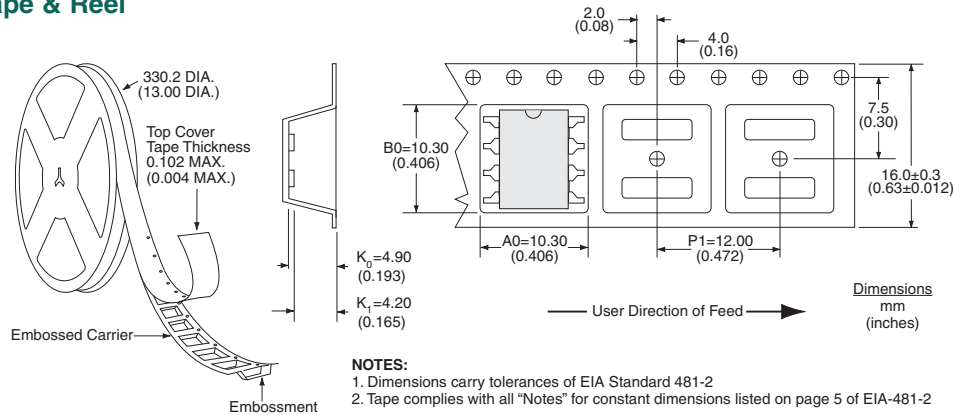

For additional information please visit our website at: <https://www.littelfuse.com>