

Parameter	Rating	Units
Blocking Voltage	350	$V_P$
Load Current	100	$mA_{rms} / mA_{DC}$
On-Resistance (max)	35	$\Omega$

### Features

- 3750V<sub>rms</sub> Input/Output Isolation
- Three Functions in One Package
- Bidirectional Current Sensing
- Bidirectional Current Switching
- FCC Compatible
- No EMI/RFI Generation
- Small 16-Pin SOIC Package
- Tape & Reel Version Available

### Applications

- Telecommunications
  - Telecom Switching
  - Tip/Ring Circuits
  - Modem Switching (Laptop, Notebook, Pocket Size)
  - Hook Switch
  - Dial Pulsing
  - Ground Start
  - Ringing Injection
- Instrumentation
- Multiplexers
- Data Acquisition
- Electronic Switching
- I/O Subsystems
- Meters (Watt-Hour, Water, Gas)
- Medical Equipment-Patient/Equipment Isolation
- Security
- Industrial Controls

### Description

The IAA110P Multifunction Telecom switch combines two 350V normally open (1-Form-A) relays and one optocoupler in a single package. The relays use optically coupled MOSFET technology to provide 3750V<sub>rms</sub> of input to output isolation. The efficient MOSFET switches and photovoltaic die use IXYS Integrated Circuits Division's patented OptoMOS architecture while the inputs' highly efficient infrared LEDs control the outputs. The IAA110P allows telecom circuit designers to combine three discrete functions in a single component that occupies less space than traditional discrete component solutions.

### Approvals

- UL Recognized Component: File E76270
- CSA Certified Component: Certificate 1305490
- EN62368-1 Certified Component:  
TUV Certificate: B 082667 0008 Rev 00

### Ordering Information

Part #	Description
IAA110P	16-Pin SOIC (50/Tube)
IAA110PTR	16-Pin SOIC (1000/Reel)

### Pin Configuration

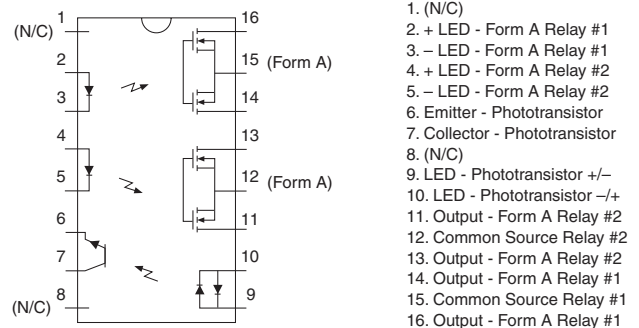

### Switching Characteristics of Normally Open Devices

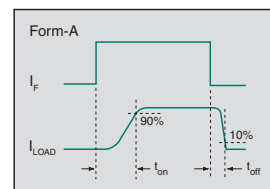

**Absolute Maximum Ratings @ 25°C**

Parameter	Symbol	Ratings	Units
Input Control Current, Relay	$I_F$	50	mA
Total Package Dissipation <sup>1</sup>	$P_T$	1	W
Isolation Voltage, Input to Output	$V_{ISO}$	3750	$V_{rms}$
Operational Temperature	$T_A$	-40 to +85	°C
Storage Temperature	$T_{STG}$	-40 to +125	°C

<sup>1</sup> Derate linearly 1.67 mW / °C

Absolute Maximum Ratings are stress ratings. Stresses in excess of these ratings can cause permanent damage to the device. Functional operation of the device at conditions beyond those indicated in the operational sections of this data sheet is not implied.

Typical values are characteristic of the device at +25°C, and are the result of engineering evaluations. They are provided for information purposes only, and are not part of the manufacturing testing requirements.

**Electrical Characteristics @25°C: Relay Section**

Parameter	Conditions	Symbol	Min	Typ	Max	Units
<b>Output Characteristics</b>						
Blocking Voltage (Peak)	$I_L=1\mu A$	$V_L$	-	-	350	$V_P$
Load Current						
Continuous	-	$I_L$	-	-	100	$mA_{rms} / mA_{DC}$
Peak	$t=10ms$	$I_{LPK}$	-	-	350	$mA_P$
On-Resistance	$I_L=100mA$	$R_{ON}$	-	-	35	$\Omega$
Off-State Leakage Current	$V_L=350V, T_J=25^\circ C$	$I_{LEAK}$	-	-	1	$\mu A$
<b>Switching Speeds</b>						
Turn-On	$I_F=5mA, V_L=10V$	$t_{on}$	-	-	3	ms
Turn-Off		$t_{off}$	-	-	3	ms
Output Capacitance	$V_L=50V, f=1MHz$	$C_{OUT}$	-	25	-	pF
<b>Input Characteristics</b>						
Input Control Current to Activate	$I_L=100mA$	$I_F$	-	-	5	mA
Input Control Current to Deactivate	$I_L=1mA$	$I_F$	0.4	-	-	mA
Input Voltage Drop	$I_F=5mA$	$V_F$	0.9	1.2	1.4	V
Reverse Input Voltage	-	$V_R$	-	-	5	V
Reverse Input Current	$V_R=5V$	$I_R$	-	-	10	$\mu A$

**Electrical Characteristics @25°C: Detector Section**

Parameter	Conditions	Symbol	Min	Typ	Max	Units
<b>Output Characteristics</b>						
Phototransistor Blocking Voltage	$I_C=10\mu A$	$BV_{CEO}$	20	50	-	V
Phototransistor Dark Current	$V_{CE}=5V, I_F=0mA$	$I_{CEO}$	-	50	500	nA
Saturation Voltage	$I_C=2mA, I_F=16mA$	$V_{SAT}$	-	0.3	0.5	V
Current Transfer Ratio	$I_F=6mA, V_{CE}=0.5V$	CTR	33	-	-	%
<b>Input Characteristics</b>						
Input Control Current	$I_C=2mA, V_{CE}=0.5V$	$I_F$	-	2	6	mA
Input Voltage Drop	$I_F=5mA$	$V_F$	0.9	1.2	1.4	V
Input Current (Detector Must be Off)	$I_C=1\mu A, V_{CE}=5V$	-	5	25	-	$\mu A$
Capacitance, Input to Output	$V_L=50V, f=1MHz$	$C_{I/O}$	-	3	-	pF
Isolation, Input to Output	-	$V_{I/O}$	3750	-	-	$V_{rms}$

COMMON PERFORMANCE DATA\*

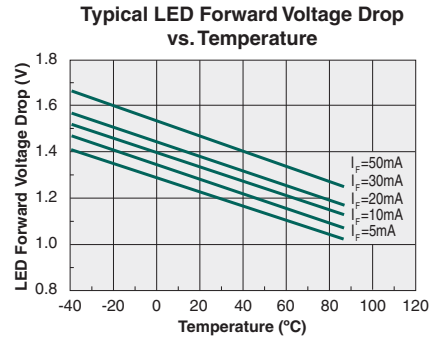
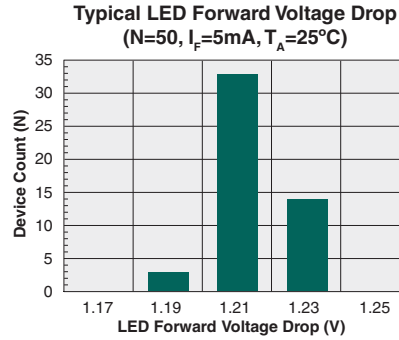

RELAY PERFORMANCE DATA\*

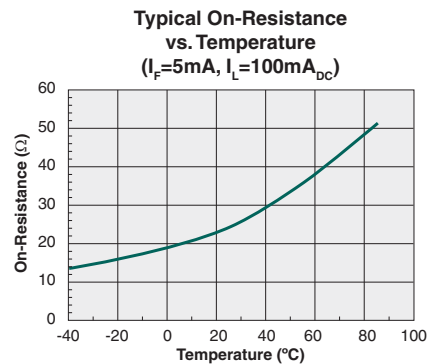
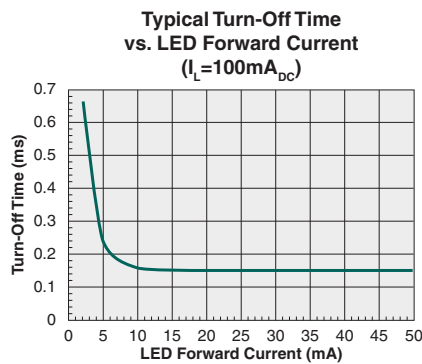
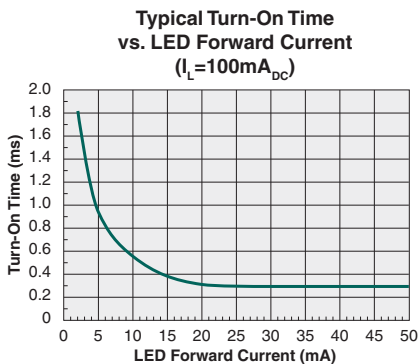
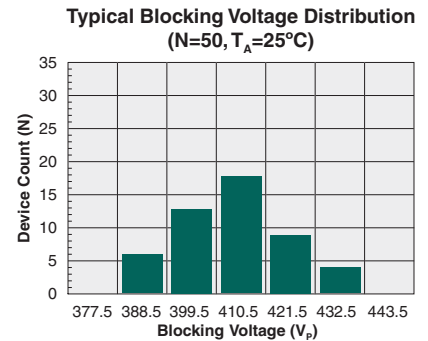
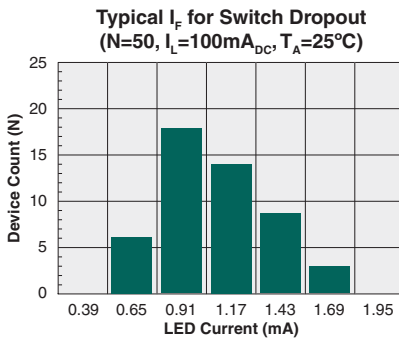
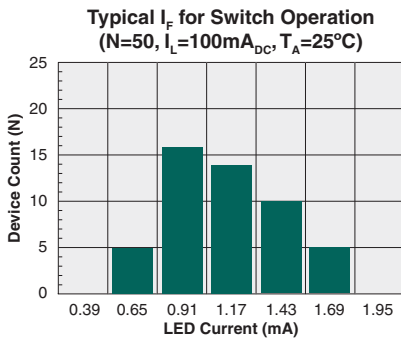
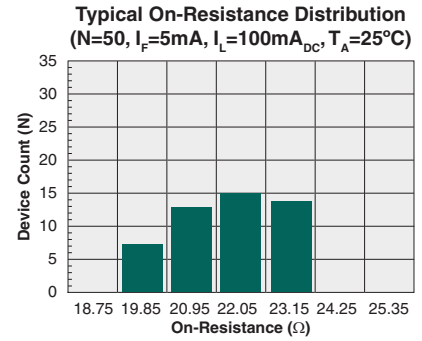
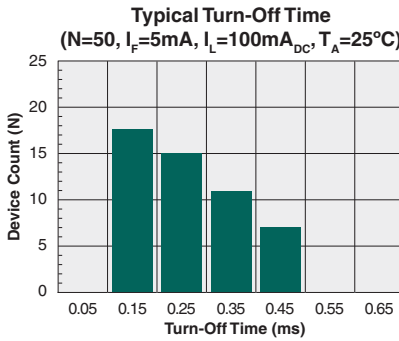
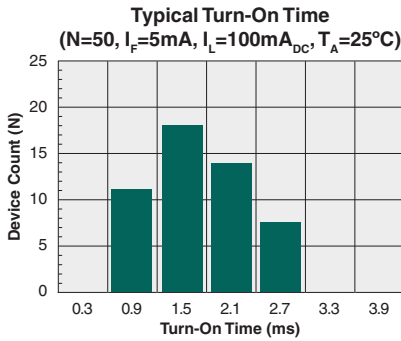

\* Unless otherwise noted, data presented in these graphs is typical of device operation at 25°C.

**RELAY PERFORMANCE DATA (cont.)\***

**Typical Turn-On Time vs. Temperature**  
( $I_L=100\text{mA}_{DC}$ )

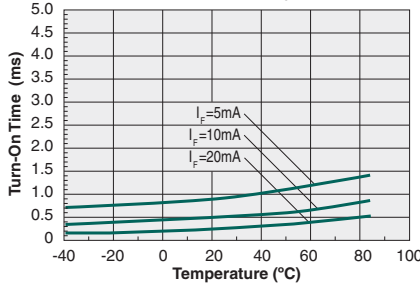

**Typical Turn-Off Time vs. Temperature**  
( $I_F=5\text{mA}$ ,  $I_L=100\text{mA}_{DC}$ )

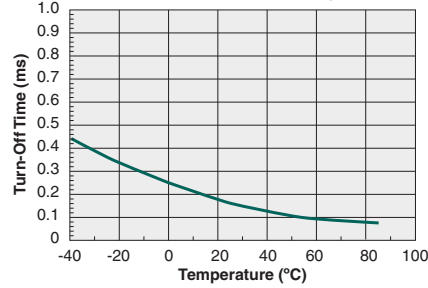

**Maximum Load Current vs. Temperature**

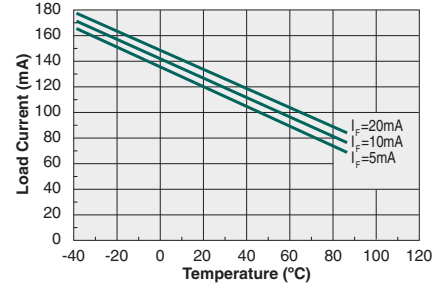

**Typical  $I_F$  for Switch Operation vs. Temperature**  
( $I_L=100\text{mA}_{DC}$ )

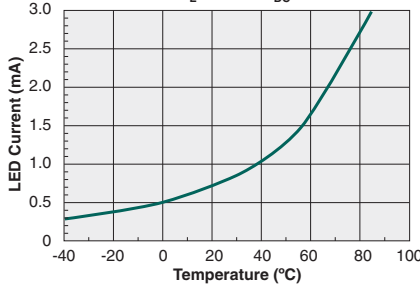

**Typical  $I_F$  for Switch Dropout vs. Temperature**  
( $I_L=100\text{mA}_{DC}$ )

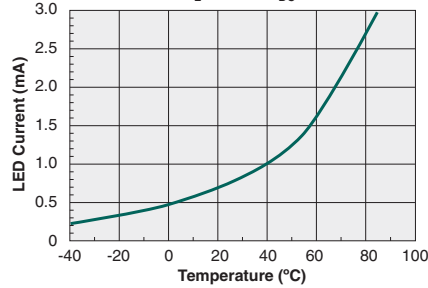

**Typical Load Current vs. Load Voltage**  
( $I_F=5\text{mA}$ ,  $T_A=25^\circ\text{C}$ )

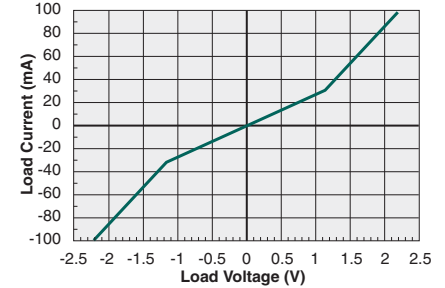

**Typical Blocking Voltage vs. Temperature**

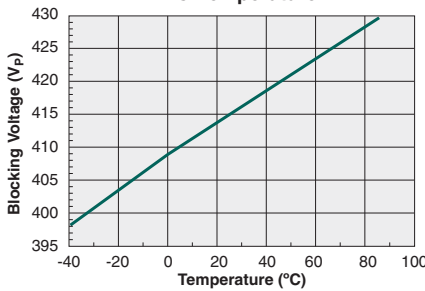

**Typical Leakage vs. Temperature Measured Across Pins 14&16 or 11&13**

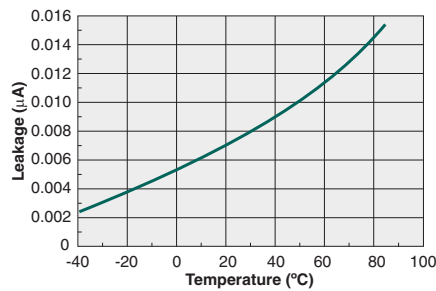

**Energy Rating Curve**

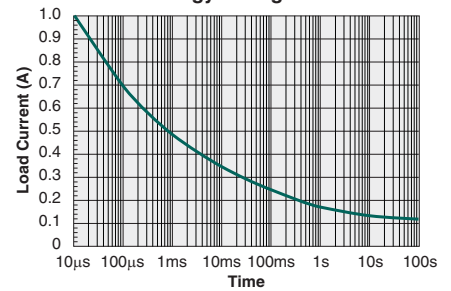

**DETECTOR PERFORMANCE DATA \***

**Typical Normalized CTR vs. Forward Current**  
( $V_{CE}=0.5\text{V}$ )

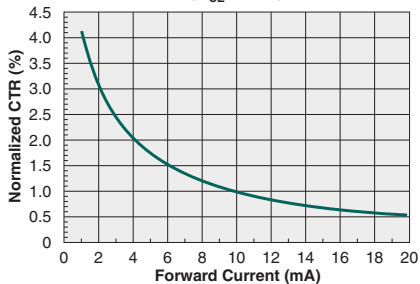

**Typical Normalized CTR vs. Temperature**  
( $V_{CE}=0.5\text{V}$ )

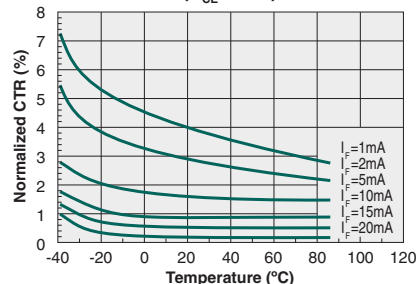

**Typical Collector Current vs. Forward Current**  
( $V_{CE}=0.5\text{V}$ )

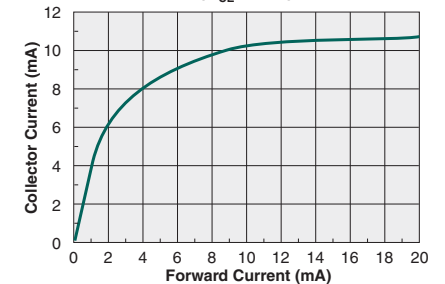

\* Unless otherwise noted, data presented in these graphs is typical of device operation at 25°C.

**Manufacturing Information**

**Moisture Sensitivity**



All plastic encapsulated semiconductor packages are susceptible to moisture ingress. IXYS Integrated Circuits classifies its plastic encapsulated devices for moisture sensitivity according to the latest version of the joint industry standard, **IPC/JEDEC J-STD-020**, in force at the time of product evaluation. We test all of our products to the maximum conditions set forth in the standard, and guarantee proper operation of our devices when handled according to the limitations and information in that standard as well as to any limitations set forth in the information or standards referenced below.

Failure to adhere to the warnings or limitations as established by the listed specifications could result in reduced product performance, reduction of operable life, and/or reduction of overall reliability.

This product carries a **Moisture Sensitivity Level (MSL)** classification as shown below, and should be handled according to the requirements of the latest version of the joint industry standard **IPC/JEDEC J-STD-033**.

Device	Moisture Sensitivity Level (MSL) Classification
IAA110P	MSL 3

**ESD Sensitivity**



This product is ESD Sensitive, and should be handled according to the industry standard **JESD-625**.

**Soldering Profile**

Provided in the table below is the **IPC/JEDEC J-STD-020** Classification Temperature ( $T_C$ ) and the maximum dwell time the body temperature of these surface mount devices may be ( $T_C - 5$ )°C or greater. The Classification Temperature sets the Maximum Body Temperature allowed for these devices during reflow soldering processes.

Device	Classification Temperature ( $T_C$ )	Dwell Time ( $t_p$ )	Max Reflow Cycles
IAA110P	245°C	30 seconds	3

**Board Wash**

IXYS Integrated Circuits recommends the use of no-clean flux formulations. Board washing to reduce or remove flux residue following the solder reflow process is acceptable provided proper precautions are taken to prevent damage to the device. These precautions include but are not limited to: using a low pressure wash and providing a follow up bake cycle sufficient to remove any moisture trapped within the device due to the washing process. Due to the variability of the wash parameters used to clean the board, determination of the bake temperature and duration necessary to remove the moisture trapped within the package is the responsibility of the user (assembler). Cleaning or drying methods that employ ultrasonic energy may damage the device and should not be used. Additionally, the device must not be exposed to halide flux or solvents.



MECHANICAL DIMENSIONS

IAA110P

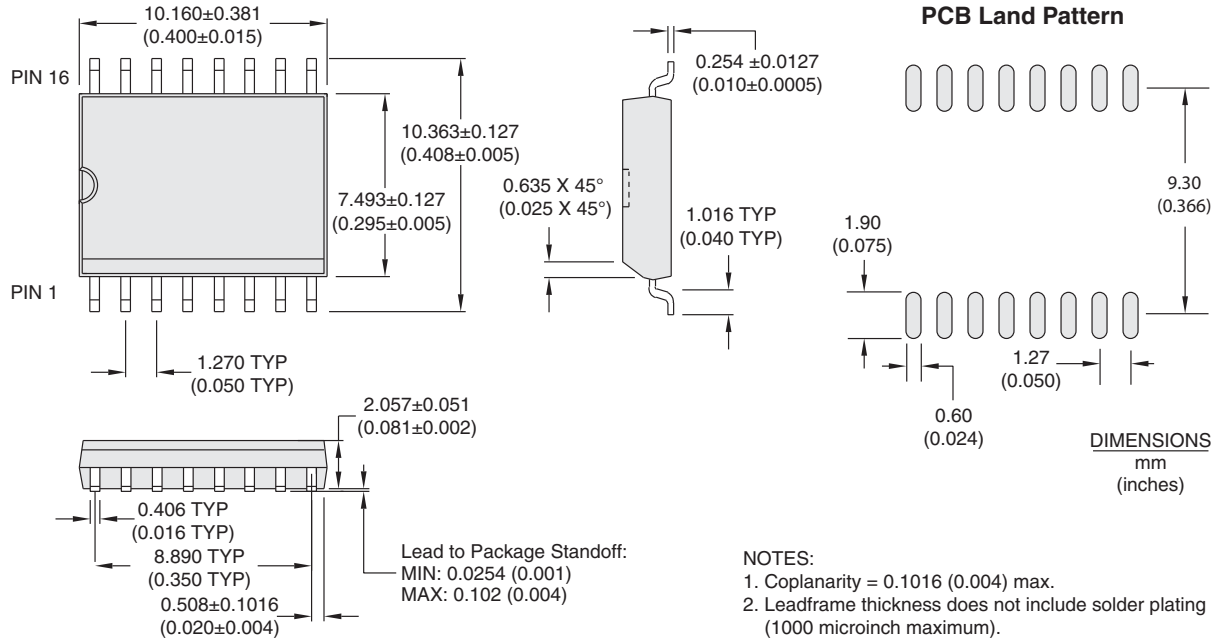

IAA110PTR Tape & Reel

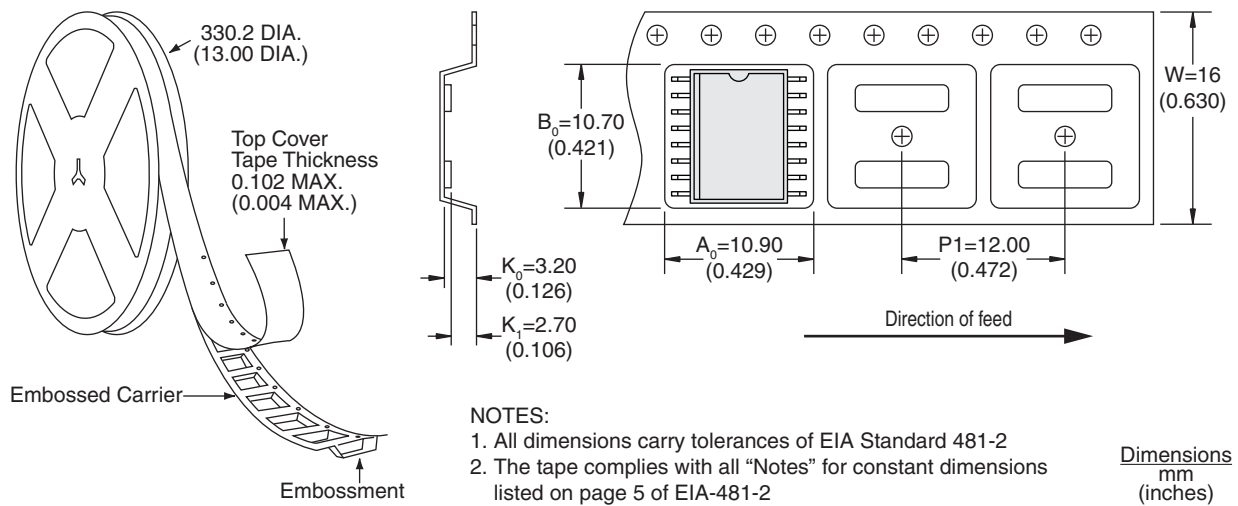

For additional information please visit our website at: <https://www.ixysic.com>