

INSTALLATION INSTRUCTIONS

Revision B1
Rapid City, SD, USA, 02/2010

Motorsaver®
ELECTRONIC MOTOR
CONTROL & PROTECTION

MODELS 201A-AU 201-575-AU



II-201A-AU-B

DANGER!



HAZARDOUS VOLTAGES MAY BE PRESENT DURING INSTALLATION.

Electrical shock can cause death or serious injury.

Installation should be done by qualified personnel following all national, state and local electrical codes.



**BE SURE POWER IS DISCONNECTED PRIOR TO INSTALLATION!
FOLLOW NATIONAL, STATE AND LOCAL CODES.
READ THESE INSTRUCTIONS ENTIRELY BEFORE INSTALLATION.**

SymCom's MotorSaver[®] Model 201A-AU is an auto ranging plug-in voltage / phase monitor designed to protect 3-phase motors regardless of size. It is used on 190-480VAC (475-600 for Model 201-575-AU), 50/60 Hz motors to prevent damage caused by single-phasing, low voltage, high voltage, phase reversal, or voltage unbalance conditions.

CONNECTIONS

1. Locate a convenient location in or near the motor control panel. If the location is wet or dusty, the MotorSaver[®] should be mounted in a NEMA 4 or 12 enclosure.
2. Mount an 8-pin socket to the motor control back panel (SymCom P/N OT08-PC, sold separately, is required for UL rating).
3. Connect L1, L2 and L3 (terminals 3, 4 & 5 on the relay socket) to the LINE SIDE of the motor starter as shown in Figure 1.
4. Connect the output relay to the circuitry to be controlled. For motor control, connect the normally open contact in series with the magnetic coil of the motor starter, and for alarm operation, connect the normally closed contact in series with the control circuit. See Figure 1 for details.
5. Plug the MotorSaver[®] into the socket.

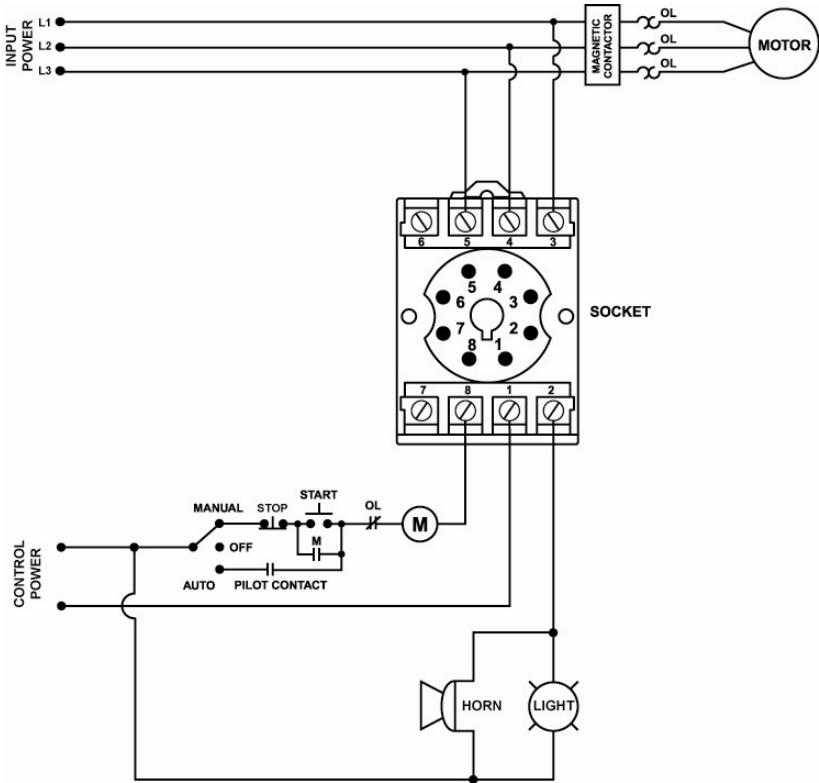

Figure 1: Typical Wiring Diagram for Control and Alarm

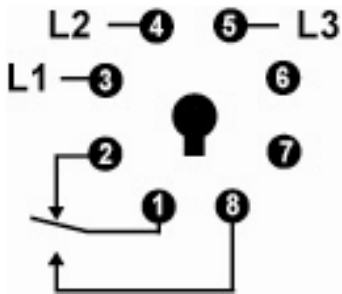

Figure 2: Pin-Out Diagram

SETTINGS

Rotate the knobs to the appropriate setting for the application following the guidelines below. Do **not** apply excessive force when adjusting settings.

Line Voltage

Rotate the VOLT ADJ. (VAC) knob to the nominal 3-phase line voltage feeding the motor to be protected.

Restart Delay

Rotate the RESTART (SEC) knob to the desired position. The restart delay is the time between the MotorSaver® measuring acceptable voltage and closing its output contacts. For compressor applications, the restart delay should be set for the approximate time it takes for the head pressure to bleed off of the compressor. For other applications, the restart delay is typically set between 10 and 20 seconds.

Trip Delay

Rotate the TRIP DELAY (SEC) knob to the desired setting. This setting does not affect the trip delay on single-phasing faults (See SPECIFICATIONS Table). Typically, the trip delay is set between 1 and 5 seconds. In areas where voltage fluctuations are frequent, the trip delay may be set greater than 10 seconds.

Voltage Unbalance

Rotate the UNBALANCE TRIP (NEMA%) knob to the desired unbalance trip level. The NEMA MG1 standard does not recommend operating a motor above 1% voltage unbalance without derating the motor. The NEMA MG1 standard also recommends against operating a motor above a 5% voltage unbalance under any circumstances. SymCom recommends consulting the motor manufacturer for specific tolerances.

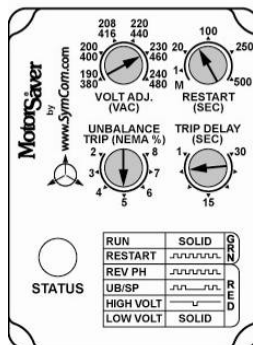

Figure 3: Adjustment Knobs

Calculating Voltage Unbalance

NEMA MG1 Unbalance Formula

$$\% \text{ Voltage Unbalance} = \frac{\text{Maximum Deviation from the Average}}{\text{Average}} \times 100\%$$

Example: The measured line-to-line voltages are 203, 210, and 212.

$$\text{Average} = \frac{203 + 210 + 212}{3} = 208.3$$

The maximum deviation from the average is the largest difference between the average voltage (208.3) and any one voltage reading.

$$208.3 - 203 = 5.3 \quad 210 - 208.3 = 1.7 \quad 212 - 208.3 = 3.7$$

The maximum deviation from the average is 5.3.

$$\% \text{ voltage unbalance} = \frac{5.3}{208.3} \times 100 = 2.5\% \text{ unbalance}$$

OPERATION

After applying power to the MotorSaver[®], the green RUN light will blink during the restart delay. After the restart delay time has expired, the MotorSaver[®] will energize its output contacts (open the normally closed and close the normally open contacts) and the RUN light will turn solid green.

Automatic Reset Mode

Set the RESTART (SEC) knob to the desired restart delay time. Apply 3-phase power to the motor. The MotorSaver's green RUN light will blink during the restart delay. Once the restart delay time has expired, the MotorSaver[®] will energize its output contacts and the green RUN light will illuminate.

Manual Reset Mode

Once power has been applied to the MotorSaver[®], set the RESTART (SEC) knob to **M** to operate in manual reset mode. When the MotorSaver[®] trips on a fault, the red STATUS light will display the fault code until the condition clears and the unit is reset by turning the RESTART (SEC) knob away from the **M** position until the STATUS light turns green. The RESTART (SEC) knob can then be turned back to the **M** position, requiring a manual reset after the next fault occurs. If power is lost before the MotorSaver[®] is reset, the fault code will again be displayed once power is reapplied. This allows for identification of the last fault even after power conditions have returned to normal.

If the contacts do not energize and the RUN light does not turn solid green, see the TROUBLESHOOTING section.











<u>STATUS</u>	INDICATOR LIGHT
GREEN	RUN
 GREEN	RESTART DELAY (Automatic Reset Mode)
 GREEN	MANUAL RESET REQUIRED (Manual Reset Mode)
 RED	REVERSE PHASE
 RED	UNBALANCE / SINGLE PHASE
 RED	HIGH VOLTAGE
RED	LOW VOLTAGE

Table 1: Diagnostic Indicator Lights

TROUBLESHOOTING

SYMPTOM	LIGHT PATTERN	SOLUTION
No lights are on - the unit seems completely dead	N/A	Verify L1, L2 & L3 are connected to terminals 3, 4 & 5. Measure the three line-to-line voltages. If any of the voltages are below the specified operating voltage, the MotorSaver® does not have enough power to operate its internal electronics. If the voltages are correct, call SymCom at (800) 843-8848 or (605) 348-5580.
Red light is blinking (on initial power-up)	 RED	Turn off the 3-phase power. Swap any two leads powering the MotorSaver® (L1, L2, or L3). There is a 50-50 chance of connecting L1, L2 and L3 correctly the first time. Reapply 3-phase power.
Red light is blinking (after the motor has been running)	 RED	The incoming lines have been reverse-phased. The MotorSaver® is preventing the motor from running backwards. Correct the phase sequence.
Red light is blinking in this pattern	 RED	The voltage is unbalanced or single-phased. Measure the incoming line voltages and calculate the % unbalance according to the procedure outlined earlier in this document. If the voltage unbalance does not exceed the % unbalance reset value, call SymCom at (800) 843-8848 or (605) 348-5580.
Red light is blinking in this pattern	 RED	The voltage is high. Measure the three line-to-line voltages. Calculate the average according to the NEMA unbalance formula. If the average voltage is 7% above the nominal voltage as selected by the LINE VOLTAGE ADJUST setting, the MotorSaver® is functioning properly. If the voltage is within 7%, call SymCom at (800) 843-8848 or (605) 348-5580.
Red light is on steady	RED	The voltage is low. Measure the three line-to-line voltages. Calculate the average according to the NEMA unbalance formula. If the average voltage is 7% below the nominal voltage as selected by the LINE VOLTAGE ADJUST setting, the MotorSaver® is functioning properly. If the voltage is within 7%, call SymCom at (800) 843-8848 or (605) 348-5580.
Green light blinks and motor is not running	 GREEN	The MotorSaver® is timing through the restart delay and will energize its contacts when finished, or the MotorSaver® is in manual reset mode and requires a manual reset to energize its contacts.
Green light is on steady, but motor does not start	GREEN	The MotorSaver® is in run mode. Ensure other control devices are allowing the motor to start. Check control circuit for loose wires or malfunctioning switches.

DIMENSIONS

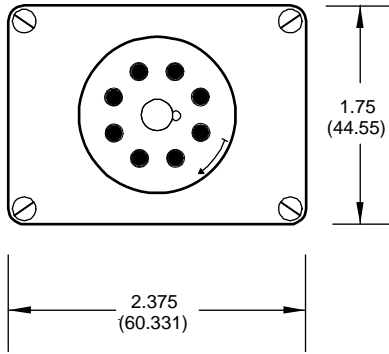

BOTTOM

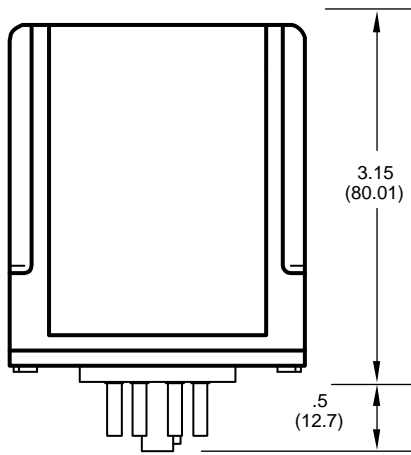

SIDE

NOTE: Use of the OT08-PC or RB08-PC octal socket, manufactured by Custom Connector Corp., is required for the MotorSaver to qualify as a UL Listed device. The OT08-PC is 35mm DIN rail compatible.

MOTORSAVER® 201A-AU SPECIFICATIONS

Functional Characteristics	
Low Voltage	
Trip	90% of setting
Reset	93% of setting
High Voltage	
Trip	110% of setting
Reset	107% of setting
Voltage Unbalance	
Trip	2-8%
Reset	Trip setting - 1% (5-8%) Trip setting - 0.5% (2-4%)
Trip Delay	
High/Low Voltage and Unbalance	1-30 seconds, adjustable
Single-Phasing	1 second, fixed
Restart Delay	1-500 seconds, adjustable; Manual
Input Characteristics	
Line Supply Voltage	
201A-AU	190-480VAC
201-575-AU	475-600VAC
Frequency	50/60Hz
Output Characteristics	
Output Contact Rating	
Pilot Duty	480VA @ 240VAC
General Purpose	10A @ 240VAC
General Characteristics	
Environmental	
Ambient Operating Temperature ¹	-40° to 70°C (-40° to 158°F)
Relative Humidity	10-95%, non-condensing per IEC 68-2-3
Maximum Input Power	5 W
Standards Passed	
Electrostatic Discharge (ESD)	IEC 61000-4-2, Level 3, 6kV contact, 8kV air
Radio Frequency Immunity, Radiated	150 MHz, 10V/m
Fast Transient Burst	IEC 61000-4-4, Level 4, 4kV input power and controls
Surge Immunity	
IEC	IEC 61000-4-5, Level 4, 4kV line-to-line; Level 4, 4kV line-to-ground
ANSI/IEEE	C62.41 Surge and Ring Wave Compliance to a level of 6kV line-to-line
Hi-Potential Test	Meets UL508 (2 x rated V +1000 V for 1 minute)
Safety Marks	
UL listed (OT08 octal socket required)	UL508 (File #E68520)
CE	IEC 60947-6-2
Dimensions	1.750" H x 2.375" W x 4.125" D (with socket)
Weight	9 oz.
Enclosure	Polycarbonate
Mounting Method	Plugs into OT08 Socket
Wire Gauge	12-22 AWG Solid or Stranded
Terminal Torque for P/N OT08 Socket	12 in. - lb

¹ The ambient air temperature is the air temperature directly surrounding the product.

NOTES

NOTES

For warranty information, please see **Terms and Conditions** at
www.symcom.com

*Visit us at www.symcom.com to see
our complete product listing!*

Need something special?

*Contact SymCom today
for your custom solution!
800-843-8848*