



INSTALLATION INSTRUCTIONS FOR SYMCOM'S MODEL 777-ACCUPOWER w/4-20mA

POWER MONITOR
MOTOR PROTECTION RELAY
OVERLOAD RELAY

**BE SURE POWER IS DISCONNECTED PRIOR TO INSTALLATION!
FOLLOW NATIONAL, STATE AND LOCAL CODES!
READ THESE INSTRUCTIONS ENTIRELY BEFORE INSTALLATION.**

The Model 777-AccuPower is a fully-programmable, solid-state power monitor/motor protection relay for use on 3-phase systems with operating voltages of 190–480VAC. The Model 777-AccuPower allows motor hp rating, full load amps, efficiency, and power factor to be entered and will accurately calculate and display motor output power. The 777-AccuPower can be used with SymCom's 4–20mA output module to give an analog signal proportional to this output power. The Model 777-AccuPower can be programmed prior to installation by applying 120VAC to terminals L1 and L2. The unit CANNOT be tested for proper operation using this voltage. For testing purposes, 3-phase power must be used with a minimum voltage of 190VAC.

! DANGER !

HAZARDOUS VOLTAGES MAY BE PRESENT DURING INSTALLATION.

Electrical shock can cause death or serious injury.

Installation should be done by qualified personnel following all national, state and local electrical codes.



CONNECTIONS

1. Disconnect power and verify power is off.
2. Using the four corner tabs or the DIN rail mount, mount the Model 777-AccuPower directly above or below the contactor. To use the DIN rail mount, hook the top clip first then apply downward pressure until the lower clip snaps onto the rail.
3. A) For amperage ranging from 25–90 amps (2–9 amps for -LR model), insert the motor conductors through the hole marked A, B, and C. Make certain the conductor through each hole corresponds to the right motor conductor, i.e. the A phase conductor should go through the A round hole. See Figure 1 for a typical wiring diagram.
B) For amperage less than 25 amps (1–2 amps for -LR model), loop the motor conductors according to Table 1. Figure 2 shows an example of the looping required for current ranging from 8.1 to 12 amps (MULT=3).
C) For amperage greater than 90 amps, external CTs (current transformers) are required. SymCom recommends using CTs with terminals to simplify installation. All CT secondaries must make five passes through the round holes on the PumpSaver. See Figure 3 for a typical wiring diagram using external CTs.

NOTE: Pay close attention to this diagram to eliminate any power factor errors that will create errors in the horsepower measurements.

4. Connect the 3-phase power from the line side of the contactor to terminals L1, L2, and L3 using 12–18 AWG copper wire (See Figure 1). Figure 1 is drawn for a power system wired in ABC phase sequence. For power systems with ACB phase sequence, switch L1 and L3 connections to the Model 777-AccuPower.
5. Connect the control circuit wires to the appropriate terminals. The device is designed to be fail safe so the NO (normally open) contact should be in series with the coil on the contactor for motor control (see Figure 1), and the NC (normally closed) contact in series with the alarm circuitry.



www.SymCom.com

...your electronic control & protection specialists

222 Disk Drive, Rapid City, SD 57701
(800) 843-8848 www.symcom.com

Model	Recommended Full Load Amps	OC Range (Amps)	# of Passes through each Window	MULT (CT Ratio)	
777-LR-AccuPower	1-2	1.00-5.00	2	2	
	2-9	2.00-10.0	1	1	
777-AccuPower	2-2.5	2.00-10.0	10	10	
	2.5-3	2.22-11.1	9	9	
	3-3.5	2.50-12.5	8	8	
	3.5-4	2.85-14.2	7	7	
	4-5	3.33-16.6	6	6	
	5-6	4.00-20.0	5	5	
	6-8	5.00-25.0	4	4	
	8-12	6.66-33.3	3	3	
	12-25	10.0-50.0	2	2	
	25-90	20.0-100	1	1	
	∪ External CTs Required ∪				
	80-110	80-140	5	100 (100:5)	
	110-160	120-210	5	150 (150:5)	
	160-220	160-280	5	200 (200:5)	
	220-320	240-420	5	300 (300:5)	
320-420	320-560	5	400 (400:5)		
400-520	400-700	5	500 (500:5)		
480-600	480-840	5	600 (600:5)		
540-700	560-980	5	700 (700:5)		
560-800	640-992	5	800 (800:5)		

Table 1. Wiring Configuration Based on Motor Full Load Amps

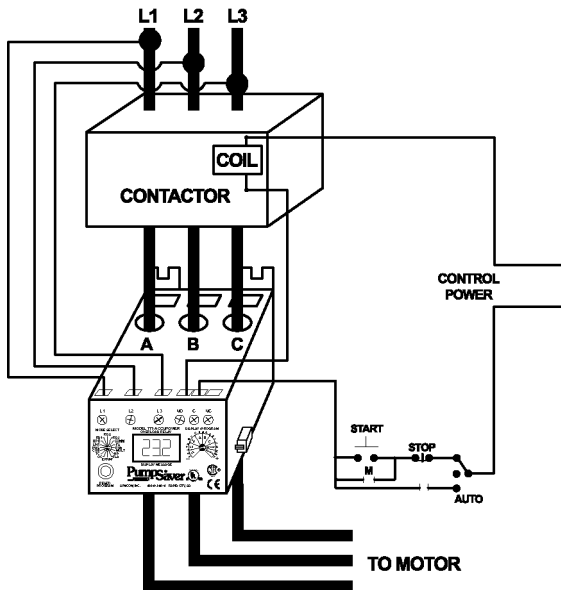
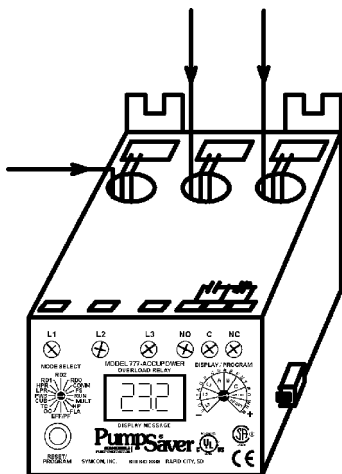

Figure 1. Typical Wiring Diagram for FLA of 25-90 (ABC phase sequence*)

*For input power configuration of ACB phase sequence, switch L1 and L3 on the Model 777-AccuPower's input terminals.



**Figure 2. Looping Example Showing Three Conductors (MULT=3 from Table 1)
(No other necessary connections are shown.)**

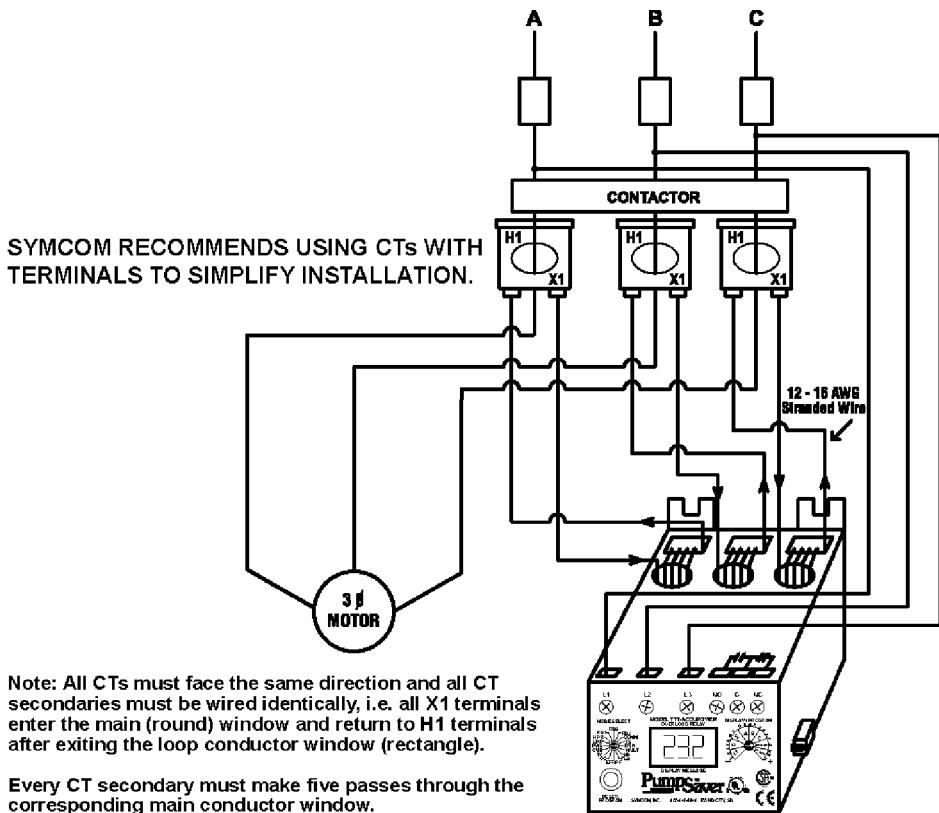

Figure 3. Typical Wiring Diagram Using External CTs

! WARNING !

UNEXPECTED OUTPUT ACTUATION CAN OCCUR.
Use hard-wired safety interlocks where personnel and/or equipment hazards exist.
Failure to follow this instruction can result in death, injury or equipment damage.

PROGRAMMABLE PARAMETERS

The following settings **MUST** be programmed by the user in order to provide proper protection for the application. All parameters are actual values except for CUB, which is programmed as a percentage. The programmable range for each parameter can be found on the specifications table on page 13. See page 9 for a programming example.

MULT - MULT (multiplier) is determined by the current the unit will be monitoring and can be found in Table 1. This allows the unit to display the correct current. Changing this setting will also change the OC, and FLA setpoints.

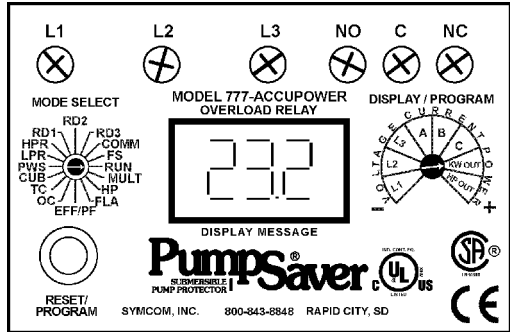

HP - HP (horsepower) should be set according to the hp rating on the nameplate of the motor. This setting is required for proper operation of the Model 777-AccuPower. The unit can be set from .10-50hp; dial in the closest available setting (select 50 if the motor is greater than 50hp.)

FLA- FLA (full load amps) is the current drawn while the motor is running normally and can be read from the nameplate. EFF is automatically calculated and set when HP and FLA are programmed, so if FLA is not entered, EFF must be programmed manually.

EFF/PF- EFF/PF (efficiency/power factor) can be found on the motor's nameplate or manufacturer's specification sheet. If the efficiency rating is available, it is best to enter it; and FLA should be set to 0. If the efficiency is not available, it will automatically be calculated and set according to the HP and FLA settings. Power factor can also be entered according to the motor's nameplate or manufacturer's specification sheet, and should be entered if available.

OC - OC (overcurrent) is usually set at the service factor amperage (typically 100-115% of motor FLA) of the motor, which is determined by the motor manufacturer. If any one leg of current exceeds the OC setting, the unit will follow its overload trip curve (see Figure 4).

TC - TC (trip class) is the parameter used to determine when the unit will trip when an overload condition is detected. For standard motors, the TC is typically set at 20. The motor manufacturer should be contacted for exact TC settings. Table 4 and Figure 4 show the range of TC settings and trip times.

CUB - CUB (current unbalance) is factory set to 7%. SymCom recommends the motor manufacturer be contacted for an exact setting.

The CUB is calculated as follows:

$$\% \text{ CUB} = [(\text{Maximum deviation from the average})/\text{Average}] \times 100\%$$

Example: Measured line currents = 38, 41, and 39, so the average = $(38+41+39)/3 = 39.7$. The maximum deviation for the average is the biggest difference between the average current (39.7) and any one current reading, $39.7-38=1.7$, $41-39.7=1.3$, and $39.7-39=.7$, therefore, the maximum deviation from the average is 1.7. The CUB is then $1.7/39.7 \times 100 = 4.3\%$.

The CUB protection can be disabled by programming 999 in this setting. This will disable current unbalance protection and current single phasing protection.

PWS - PWS (power scale) is the range setting for the LPR and HPR settings.

LPR- LPR (low power setting) is used to shut down the motor or pump on an underload condition. Setting LPR to 0 disables the underload trip feature. LPR is set in either kilowatts (kW) or horsepower (hp) depending on the PWS setting.

NOTE: PWS must be set before setting LPR.

PWS	LPR & HPR RANGE
1	.01-.99 kW
2	1.00-9.95 kW
3	10.0-99.5 kW
4	100-650 kW
5	.01-1.32 hp
6	1.34-13.3 hp
7	13.4-133 hp
8	134-871 hp

HPR- HPR (high power setting) is used to shut down the motor or pump on an overpower condition; unit will display "HPR." The high power trip uses the motor cool down timer (RD2) to delay restarts. The Model 777-AccuPower is shipped from the factory with this feature disabled ("OFF").

RD1 - RD1 (restart delay one) is the rapid-cycle timer in seconds. This timer is initiated when power is first applied to the unit. If no SP or RP conditions exist when power is applied to the device, the output relay will energize (the NO contact will close and the NC will open) once the RD1 timer expires. Typically, this is set to 20-30 seconds. This will provide adequate protection for successive power outages or short cycling caused by other motor controls. This timer is also initiated when another control shuts the motor off (current goes to zero). If the user does not want the unit's relay to de-energize when another control shuts the motor off, then RD1 should be set to zero. This will also ensure when an alarm circuit is used, the alarm will sound only when there is a true problem or when power is lost.

RD2 - RD2 (restart delay two) is the restart timer used when the unit has shut off due to current unbalance, current single-phasing, overload, or high power condition. This timer is known as a motor cool-down timer. RD2 can be set from 2-500 minutes or 0, which will require a manual reset for these fault conditions. A setting of 5-10 minutes will give most motors adequate time to cool down after an overload condition. The motor manufacturer should be contacted for an exact value.

RD3- RD3 (restart delay three/dry-well recovery timer) can be set from 2-500 minutes or to “A” to enable the Automatic Dry-Well Recovery Calculator. The RD3 timer causes a restart delay after an underload (LPR) trip. Setting RD3 to 0 will require a manual reset when there is a LPR trip.

The Automatic Dry-Well Recovery Calculator allows the Model 777-AccuPower to automatically select a restart delay based on the run time of the last run cycle. Table 2 shows the next restart delay vs. run time. In general, a longer run time produces a shorter restart delay. This feature allows the Model 777-AccuPower to optimize running and rest times automatically.

Run Time	Next Restart Delay (min)	Starts/Hr
> 1 hr	6	10
30 min. – 59.99 min.	15	4
15 min. – 29.99 min.	30	2
< 15 min.	60	1

Table 2. Automatic Dry-Well Recovery Timer

COMM - COMM (communications) can be set to OP1 to use the 4-20 mA module or to set the Modbus address: A01-A99.

FS - FS (full scale) setting is required when utilizing a 4-20 mA module. PWS should already be set according to the correct hp/kW operating range of the motor; this will automatically establish the range for FS. Set FS according to the desired mA output. The module output, 4-20 mA, is directly proportional to the shaft power of the motor. A 4 mA output is always given when shaft power is zero and 20 mA when shaft power equals FS.

If a motor is running at .6 kW, PWS should be 1 (0.01-0.99 kW). To give 20 mA output when the motor is running at .6 kW, set FS to .6. The relationship of shaft power to output current is linear until the FS setpoint; shaft power usage above FS will give 20 mA. If, for example, a 16 mA typical output is desired (to give up to 20 mA if the motor is running at higher kW), set FS to .8.

$$\frac{\text{Desired mA output} - 4}{20 - 4} = X$$

$$\frac{\text{Running hp/kW}}{X} = \text{FS}$$

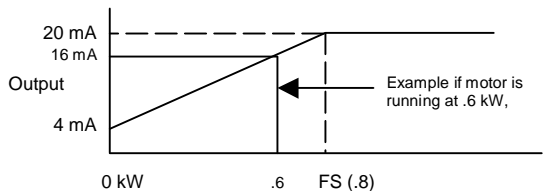

HP, FLA, PF and EFF PROGRAMMING CONSIDERATIONS

When programming the 777-AccuPower, the accuracy of the motor output power is dependent on the motor information entered into the unit.

When the horsepower (HP), full load amps (FLA), or power factor (PF) of the motor are programmed, the 777-AccuPower calculates the motor efficiency. If the rated efficiency of the motor is known, EFF should be manually programmed—this will provide the most accurate motor output power estimation. **If EFF is programmed, FLA and PF should be left at 0 and P00.**

Table 3 shows output power accuracy—most to least—based on programmed motor information.

HP	FLA	PF	EFF	MOTOR OUTPUT POWER
Required	0	P00	Manually Programmed	MOST ACCURATE
Required	Entered	Entered	Automatically Calculated	BETTER
Required	Entered	P00	Automatically Calculated	BETTER
Required	0	P00	Automatically Calculated	LEAST ACCURATE

Table 3. Motor Output Power Accuracy

PROGRAMMING

1. Rotate the MODE SELECT switch to the parameter to be programmed. SymCom recommends that MULT be programmed first, then move clockwise through the positions to complete the process.
2. Press and hold the RESET/PROGRAM button.
3. Rotate the DISPLAY/PROGRAM knob until the proper setting for the parameter that is being programmed is displayed.
4. Release the RESET/PROGRAM button. This stores the new parameter in the nonvolatile memory. **If a setting jumps back to its previous setpoint when changed, the tamper guard is locked** and must be unlocked before programming can be completed (see page 14 for tamper guard procedures).
5. Continue steps 1-4 until all parameters are programmed.

OPERATION

The relay operation of the Model 777-AccuPower is designed to be fail safe. This means when everything is within the limits programmed into the unit, the relay will energize; the NO (normally open) contact will close and the NC (normally closed) contact will open. Once the unit has been wired and programmed, the unit is ready to operate. Turn MODE SELECT to RUN. The display will show "run" alternating with some number (the numbers displayed will be the number corresponding to where the DISPLAY/PROGRAM knob is pointed). It will do this for the amount of time programmed into RD1. After this time has expired, the relay will energize (NO contact will close and NC contact will open). If something else is displayed, see the TROUBLESHOOTING section for more information. If MODE SELECT is turned out of the RUN position, the relay will de-energize.

Trip Class	Application Description
5	Small fractional horsepower motors where acceleration times are almost instantaneous or where extremely quick trip times are required.
10	(Fast Trip) Hermetic refrigerant motors, compressors, submersible pumps and general-purpose motors that reach rated speed in less than 4 seconds.
15	Specialized applications
20	(Standard Trip) Most NEMA-rated, general-purpose motors will be protected by this setting.
30	(Slow Trip) Motors with long acceleration times (>10 seconds) or high inertia loads.
J prefix	Programming any of the trip classes with the J Prefix will enable jam protection. This additional protection is enabled 1 minute after the motor starts and provides a 2-second trip time for motors exceeding 400% of the OC setting, regardless of trip class.

Table 4. Trip Class Descriptions

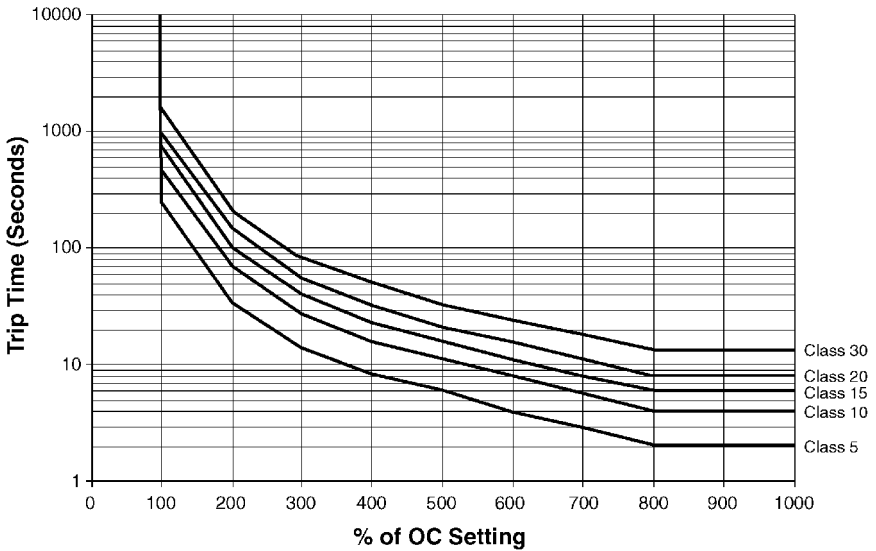

Figure 4. Overload Trip Curves

PROGRAMMING EXAMPLE

Pump to be protected: 3-phase, 460 Volt, 5 hp magnetic drive pump with a full load amperage rating of 7.1A and maximum service factor amps of 8.2. Use the following calculations and reasoning to determine the appropriate settings for this application.

MULT-	From Table 1 (pg.2), MULT = 4
HP -	5
FLA -	7.0 (closest available setting)
EFF/PF -	The Model 777-AccuPower assumes a PF and calculates efficiency to E75 (P00 will show for PF). If PF is manually set, a new efficiency is calculated. For example, if a PF of 76 is programmed into the Model 777-AccuPower (P76), a new EFF of .88 appears (E88).
OC-	Service Factor Amperage = 8.2
TC-	General purpose motor = 20
CUB-	Standard NEMA motor = 5
PWS-	2 = 1.0-9.95
LPR -	Normal pumping operation reads 2.86 kW Pump with a momentarily restricted flow (dead head) reads 1.8 kW Therefore setting is 2.0 kW (see PWS for proper range)
HPR -	Typically not used, set to OFF.
RD1 -	To protect the pump from accidental rapid cycling, RD = 20 seconds.
RD2 -	Because the motor may be hot from running in an unbalance, high power or single-phase condition, a motor cool-down time of 10 minutes, RD2 = 10, should be appropriate.
RD3 -	An underload condition is common, a 30-minute delay before restarting is necessary.
COMM -	OP1 to use 4-20 mA output module.
FS -	3.50 kW to monitor up to overpower trip point.

SYSTEM DISPLAY

The output display can show one of the following parameters when MODE SELECT is at RUN: kW or hp, each line current, or each individual line-to-line voltage. The display is also used for programming the operating parameters of the device. The display also identifies what caused the unit to de-energize its relay or what is keeping the unit from energizing its relay. The last fault, not the current fault, can be displayed by pressing and holding the RESET/PROGRAM button while the MODE SELECT switch is in the RUN position. When the unit trips off or is holding the motor off, the current fault condition will be shown in the display without pressing the button. Table 5 below lists the fault codes the unit could display.

Displayed Message	Fault
oc	Tripped on overcurrent
SP	Tripped on current single-phasing or unit won't start because the voltage is single phased
ub	Tripped on current unbalance
LPR	Tripped on low power
HPR	Tripped on high power
CF	Tripped on contact failure
RP	Incoming phases have been reversed, motor may run backwards if started
OFF	A stop command was issued from a remote source

Table 5. Fault Codes

COMMUNICATIONS PORT/REMOTE RESET

The unit comes with a 9-pin, sub-D connector for remote communications and/or for using a remotely located reset button.

If communication is desired, a communication module (part number RS485MS-2W) needs to be plugged into this 9-pin connector (this is mandatory when communicating with the unit). This module provides isolation, signal conditioning for compatibility with Modbus RTU and RS-485 networks, and provides terminals for terminating the shielded communications cable. Up to 99 units can be installed on one RS-485 network. Further information can be obtained at <http://www.symcom.com> or by calling at 1-800-843-8848.

A remote reset button can be hooked up to the communications module (pn RS485MS-2W) or can be hooked directly to the 9-pin connector using a male sub-D connector. It should be wired as shown in Figure 5.

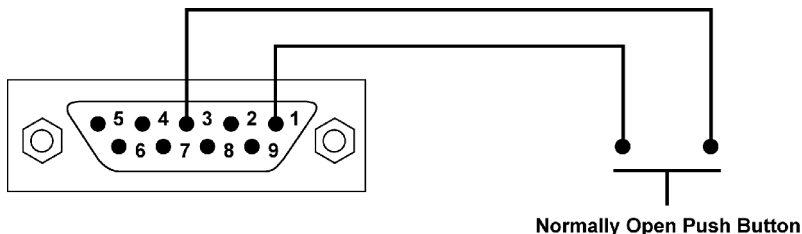

Figure 5. Remote Reset Button Wiring Diagram

TROUBLESHOOTING

The PumpSaver® will display a fault code alternating with a number or with “run” when it is in a trip condition. If the unit is showing a fault code (see Table 5) alternating with the word “run”, it has tripped on a current (amperage) condition. If the fault code is alternating with some number (voltage reading or zero), the unit will not allow the motor to start because there is a problem with the incoming voltage. If the display is showing just a fault code, the unit is in a mode that requires a manual reset. This could be because the number of restarts has expired or is not allowed. If the display is showing “off,” a stop command was issued through the communications network.

PROBLEM	SOLUTION
The unit will not start. Display alternates “rP” with the DISPLAY/PROGRAM switch parameter value.	The voltage inputs are reverse phased. If this is the initial start up, swap the leads connected to L1 and L3 on the Model 777-AccuPower to correct the problem. If the overload relay has been previously running, the power system has been reverse phased. Check the phase sequence of the incoming power lines. Note: L1 must be tapped from conductor Phase A, L2 from B, and L3 from C for correct kilowatt measurements.
Display alternates “SP”, “ub”, or “oc” with “run”	The overload relay has tripped on the fault shown on the LED display and is timing down RD2 before restarting.
Display alternates “LPR” with “run”	The overload relay has tripped on low power (LPR) and is timing down RD3 before restarting. If LPR is not a normal condition for this installation, check for loss of liquid, closed valves, broken belts, etc.
Display is showing a solid “SP”, “ub”, or “oc”	The unit has tripped on the fault shown and a manual reset is required because the programmed setting in RD2 is 0. Check the system for problems that would produce the single-phase, overload or current unbalance fault—such as a jam.
Display is showing a solid “LPR”	The unit has tripped on low power and a manual reset is required because the setting in RD3 is 0. Check the system for problems that would produce a loss of load like a broken belt or a pump is out of liquid.
Display is showing a solid “CF”	Contactor failure – the unit has tripped on a single-phasing of the current, but was not single-phased by the incoming voltage. Check for damaged contacts or loose wiring.
Unit displays currents when the motor starts but reads “0” kW or HP and trips on LPR after 4 seconds.	The unit is not wired properly to calculate correct power factor. See Figures 1, 2 & 3 for proper wiring and review step 4 in connection instructions (page 1).
Display alternates “HPR” with “run”	The overload has tripped on high power and is timing down RD2.
Display is showing solid “HPR”	The overload has tripped on high power and requires a manual reset.
Unable to change parameters	See TAMPER GUARD section on page 14

Table 6. Troubleshooting

MODEL 777-ACCUPOWER SPECIFICATIONS

Electrical

Input Voltage	200–480VAC 480–600VAC (777-575-AccuPower)
Frequency	50/60Hz
Motor Full Load Amp Range	2–25 Amps (looped) 25–90 Amps (direct) 80–800 Amps (external CTs) 1–2 Amps (777-LR-AccuPower– looped) 2–9 Amps (777-LR-AccuPower– direct)
Power Consumption	10 Watts (max.)
Output Contact Rating SPDT (Form C)	Pilot duty rating: 480VA @ 240VAC General purpose: 10A @ 240VAC

Expected Life

Mechanical	1 x 10 ⁶ operations
Electrical	1 x 10 ⁵ operations at rated load

Accuracy at 25° C (77° F)

Measured horsepower/kilowatt	±3%**
Voltage	±1%
Current	±3% (<100 amps direct)
GF Current	±15%
Timing	5% ±1 second

Repeatability

Voltage	±0.5% of nominal voltage
Current	±1% (<100 amps direct)

Current Unbalance Trip Times

<u>% Over Setpoint</u>	<u>Trip time</u>	<u>% Over Setpoint</u>	<u>Trip time</u>
1%	30 seconds	5%	6 seconds
2%	15 seconds	6%	5 seconds
3%	10 seconds	10%	3 seconds
4%	7.5 seconds	15%	2 seconds

Safety Marks

UL	UL508, UL1053
CSA	LR46510
CE	IEC 60947-1, IEC 60947-5-1

Standards Passed

Electrostatic Discharge (ESD)	IEC 1000-4-2, Level 3, 6kV contact, 8kV air
Radio Frequency Immunity (RFI), Conducted	IEC 1000-4-6, Level 3 10V/m
Radio Frequency Immunity (RFI), Radiated	IEC 1000-4-3, Level 3 10V/m
Fast Transient Burst	IEC 1000-4-4, Level 3, 3.5 kV input power

Surge

IEC	1000-4-5, Level 3, 2kV line-to-line; Level 4, 4kV line-to-ground
ANSI/IEEE	C62.41 Surge and Ring Wave Compliance to a level of 6kV line-to-line
Hi-potential Test	Meets UL508 (2 x rated V +1000V for 1 minute)
Vibration	IEC 68-2-6, 10-55Hz, 1mm peak-to-peak, 2 hours, 3 axis
Shock	IEC 68-2-27, 30g, 3 axis, 11ms duration, half-sine pulse

Mechanical	
Dimensions	3.0"H x 5.1"D x 3.6"W
Terminal Torque	7 in.-lbs.
Enclosure Material	Polycarbonate
Weight	1.2 lbs.
Maximum Conductor Size	0.65" with insulation
Environmental	
Temperature Range	Ambient Operating: -40° to 70°C (-40° to 158°F) Ambient Storage: -40° to 80° C (-40° to 176°F)
Pollution Degree	3
Class of Protection	IP20, NEMA 1
Relative Humidity	10-95%, non-condensing per IEC 68-2-3
Programmable Operating Points	Range
MULT- # of Conductors or CT Ratio (XXX:5)	1–10 Conductors or 100–800 Ratio
HP	.1–50
FLA	0, (20–207A) ÷ MULT or 0, 80–140% of CT primary (992 max.)
EFF/PF	E00–E99, P00–P99
OC- Overcurrent Threshold	(20–100A) ÷ MULT or 80–140% of CT Primary (992 max.)
TC- Overcurrent Trip Class *	5, J5, 10, J10, 15, J15, 20, J20, 30, J30
CUB- Current Unbalance Threshold	2–25% or 999%
PWS- Power Setpoint Range (for LPR and HPR setpoints)	1 = 0.01–0.99 kW 2 = 1.00–9.95 kW 3 = 10.0–99.5 kW 4 = 100–650 kW 5 = 0.01–1.30 hp 6 = 1.34–13.3 hp 7 = 13.4–133 hp 8 = 134–871 hp
NOTE: LPR can be set to "0" and HPR to "off" to disable these features	
LPR- Low Power	Range determined by PWS
HPR- High Power	Range determined by PWS
RD1- Rapid Cycle Timer	0, 2–500 Seconds
RD2- Restart Delay After All Faults Except Underload (motor cool-down timer)	0, 2–500 Minutes
RD3- Restart Delay After Underload (low-flow recovery timer)	0, 2–500 Seconds, A (Automatic)
COMM- RS485 Address	A01–A99 or OP1 for 4–20mA output
FS- Full Scale (required when using 4-20 mA module)	Full Scale Range (determined by PWS)
PWS =1	.4–1.39 kW
2	1.4–14.0 kW
3	14.0–138 kW
4	140–654 kW
5	.53–1.86 hp
6	1.87–18.7 hp
7	18.7–185 hp
8	187–877 hp

NOTES: SymCom's Power Monitor/Motor Protection Relay can be programmed prior to installation by applying 120VAC between the L1 and L2 terminals (except 575 Volt model). Power applied must be 110VAC or greater.

* If a J prefix is displayed in trip class setting, jam protection is enabled.

** on a well-balanced system within recommended current range

CLEARING LAST FAULT

To clear the last fault stored on the PumpSaver®:

1. Rotate MODE SELECT to FS.
2. Press and hold RESET/PROGRAM. Adjust DISPLAY/PROGRAM until "cLr" appears on the display. Release the RESET/PROGRAM button to verify the last fault was cleared, turn MODE SELECT to RUN. Press and hold the RESET/PROGRAM button, "cLr" should be on the display.

TAMPER GUARD

To protect the PumpSaver® from unauthorized program changes by locking in the setpoints:

1. Rotate MODE SELECT to FS.
2. Rotate DISPLAY/PROGRAM fully clockwise.
3. Press and hold the RESET button. Adjust DISPLAY/PROGRAM until "Loc" appears in the display.
4. Release the RESET button.
5. Turn MODE SELECT to RUN.

The program is now locked, but all settings can be viewed. The unit can be unlocked by following the procedure above except step three; adjust DISPLAY/PROGRAM until "unL" appears.

SymCom warrants its microcontroller-based products against defects in material or workmanship for a period of five (5) years from the date of manufacture. All other products manufactured by SymCom shall be warranted against defects in material and workmanship for a period of two (2) years from the date of manufacture. For complete information on warranty, liability, terms, returns, and cancellations, please refer to the SymCom Terms and Conditions of Sale document.

INSTALLATION INSTRUCTIONS FOR SYMCOM'S 4-20mA OUTPUT MODULE

MODULE FUNCTIONS

The 4-20mA output module provides an analog output that is proportional to a selected parameter, such as current or power. It must be used with a Model 777-AccuPower.

The 4-20mA module serves two very important functions. Its primary purpose is to convert the communications signals from the microprocessor's 5-volt levels into 4-20mA output, and to electrically isolate the 4-20mA circuit from the high voltages present in SymCom's units.

SymCom's units are connected to high AC voltages with a floating ground circuit. As long as there are three balanced line voltages present, the resulting ground level will often be near case ground. However, if one phase is lost or if the line voltages become unbalanced, the floating ground may be as much as 480 volts above the case ground. The 4-20mA module has optical isolation chips to isolate the 4-20mA output from the AC line voltages.

The signals from the microprocessor go through resistors to provide current limiting before connecting to the 9-pin external connector. Therefore, the 9-pin SUB D connector on the SymCom unit provides un-isolated CMOS signals and is NOT RS232 or TTL compatible.

Note: Do not plug a modem or other PC compatible device directly into the 9-pin SUB D connector on SymCom's units.

WIRING

The 4-20mA output module must be plugged in to the 9-pin connector on the Model 777-AccuPower. Connect the + and - terminals to the load using 18-24 AWG twisted-pair cable. Connect the shield to the terminal marked "S." The 4-20mA output module is self-powered; no external connections are required to energize the 4-20mA loop.

Terminal	Function
+	Positive 4-20 mA Output Connection
-	Negative 4-20 mA Output Connection
S	Shield Connection
	Do Not Use
	Do Not Use
	Do Not Use
	Do Not Use
	Do Not Use
	Do Not Use

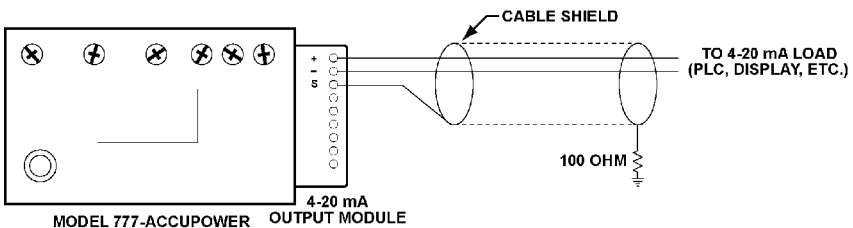

Figure 6. 4-20mA Output Module Wiring Diagram

***Visit our website at www.symcom.com for our
complete catalog and new product listings!***