

GigaMOS™ TrenchT2
HiperFET™
Power MOSFET

IXFK360N15T2
IXFX360N15T2

V_{DSS} = 150V
I_{D25} = 360A
R_{DS(on)} ≤ 4.0mΩ
t_{rr} ≤ 150ns

N-Channel Enhancement Mode
 Avalanche Rated
 Fast Intrinsic Diode

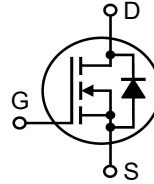

TO-264
(IXFK)

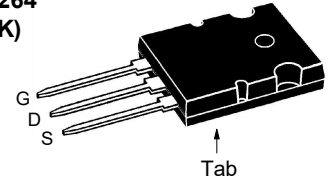

PLUS247
(IXFX)

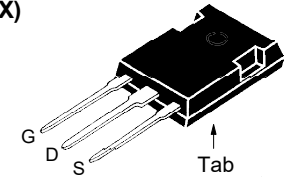

G = Gate D = Drain
 S = Source Tab = Drain

Symbol	Test Conditions	Maximum Ratings	
V _{DSS}	T _J = 25°C to 175°C	150	V
V _{DGR}	T _J = 25°C to 175°C, R _{GS} = 1MΩ	150	V
V _{GSS}	Continuous	± 20	V
V _{GSM}	Transient	± 30	V
I _{D25}	T _C = 25°C (Chip Capability)	360	A
I _{L(RMS)}	External Lead Current Limit	160	A
I _{DM}	T _C = 25°C, Pulse Width Limited by T _{JM}	900	A
I _A	T _C = 25°C	100	A
E _{AS}	T _C = 25°C	2.5	J
P _D	T _C = 25°C	1670	W
dV/dt	I _S ≤ I _{DM} , V _{DD} ≤ V _{DSS} , T _J ≤ 175°C	20	V/ns
T _J		-55 ... +175	°C
T _{JM}		175	°C
T _{stg}		-55 ... +175	°C
T _L	Maximum Lead Temperature for Soldering 1.6 mm (0.062 in.) from Case for 10s	300	°C
M _d	Mounting Torque (TO-264)	1.13/10	Nm/lb.in.
F _C	Mounting Force (PLUS247)	20..120 /4.5..27	N/lb.
Weight	TO-264	10	g
	PLUS247	6	g

Symbol	Test Conditions (T _J = 25°C Unless Otherwise Specified)	Characteristic Values		
		Min.	Typ.	Max.
BV _{DSS}	V _{GS} = 0V, I _D = 3mA	150		V
V _{GS(th)}	V _{DS} = V _{GS} , I _D = 8mA	2.5		5.0 V
I _{GSS}	V _{GS} = ± 20V, V _{DS} = 0V			± 200 nA
I _{DSS}	V _{DS} = V _{DSS} , V _{GS} = 0V T _J = 150°C			50 μA 5 mA
R _{DS(on)}	V _{GS} = 10V, I _D = 60A, Note 1			4.0 mΩ

Features

- International Standard Packages
- High Current Handling Capability
- Fast Intrinsic Diode
- Avalanche Rated
- Low R_{DS(on)}

Advantages

- Easy to Mount
- Space Savings
- High Power Density

Applications

- Synchronous Rectification
- DC-DC Converters
- Battery Chargers
- Switched-Mode and Resonant-Mode Power Supplies
- DC Choppers
- AC Motor Drives
- Uninterruptible Power Supplies
- High Speed Power Switching Applications

Symbol	Test Conditions ($T_J = 25^\circ\text{C}$ Unless Otherwise Specified)	Characteristic Values		
		Min.	Typ.	Max.
g_{fs}	$V_{DS} = 10\text{V}, I_D = 60\text{A}$, Note 1	140	230	S
C_{iss}	$V_{GS} = 0\text{V}, V_{DS} = 25\text{V}, f = 1\text{MHz}$		47.5	nF
C_{oss}			3060	pF
C_{rss}			665	pF
$t_{d(on)}$	Resistive Switching Times $V_{GS} = 10\text{V}, V_{DS} = 0.5 \cdot V_{DSS}, I_D = 100\text{A}$ $R_G = 1\Omega$ (External)		50	ns
t_r			170	ns
$t_{d(off)}$			115	ns
t_f			265	ns
$Q_{g(on)}$	$V_{GS} = 10\text{V}, V_{DS} = 0.5 \cdot V_{DSS}, I_D = 0.5 \cdot I_{D25}$		715	nC
Q_{gs}			185	nC
Q_{gd}			200	nC
R_{thJC}			0.09	$^\circ\text{C/W}$
R_{thCS}		0.15		$^\circ\text{C/W}$

Source-Drain Diode

Symbol	Test Conditions ($T_J = 25^\circ\text{C}$, Unless Otherwise Specified)	Characteristic Values		
		Min.	Typ.	Max.
I_S	$V_{GS} = 0\text{V}$			360 A
I_{SM}	Repetitive, Pulse Width Limited by T_{JM}			1440 A
V_{SD}	$I_F = 60\text{A}, V_{GS} = 0\text{V}$, Note 1			1.2 V
t_{rr}	$I_F = 160\text{A}, -di/dt = 100\text{A}/\mu\text{s}$ $V_R = 60\text{V}, V_{GS} = 0\text{V}$		0.50	150 ns
Q_{RM}				μC
I_{RM}				9.00 A

Note 1. Pulse test, $t \leq 300\mu\text{s}$; duty cycle, $d \leq 2\%$.

Littelfuse reserves the right to change limits, test conditions, and dimensions.

LF MOSFETs and IGBTs are covered by one or more of the following U.S. patents:	4,835,592	4,931,844	5,049,961	5,237,481	6,162,665	6,404,065 B1	6,683,344	6,727,585	7,005,734 B2	7,157,338 B2
	4,860,072	5,017,508	5,063,307	5,381,025	6,259,123 B1	6,534,343	6,710,405 B2	6,759,692	7,063,975 B2	
	4,881,106	5,034,796	5,187,117	5,486,715	6,306,728 B1	6,583,505	6,710,463	6,771,478 B2	7,071,537	

Fig. 1. Output Characteristics @ $T_J = 25^\circ\text{C}$

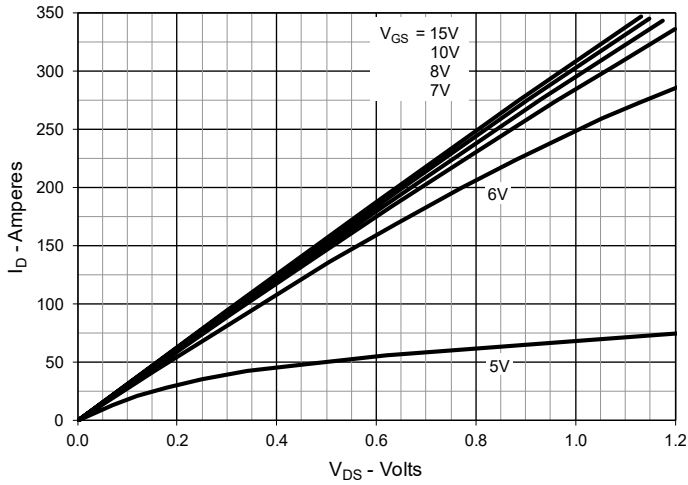

Fig. 2. Extended Output Characteristics @ $T_J = 25^\circ\text{C}$

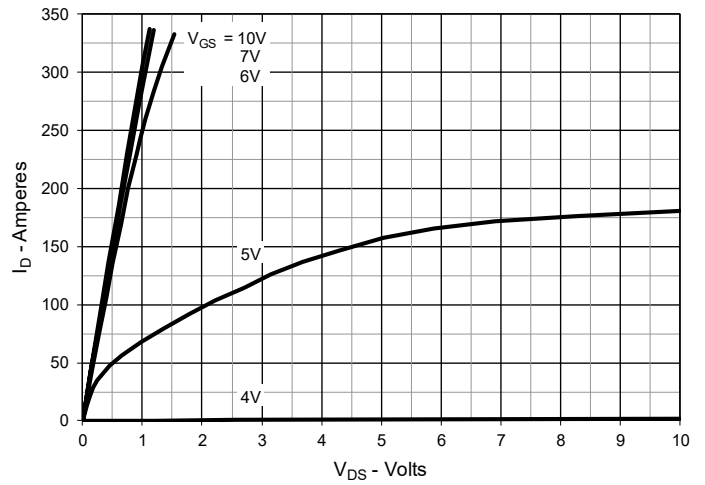

Fig. 3. Output Characteristics @ $T_J = 150^\circ\text{C}$

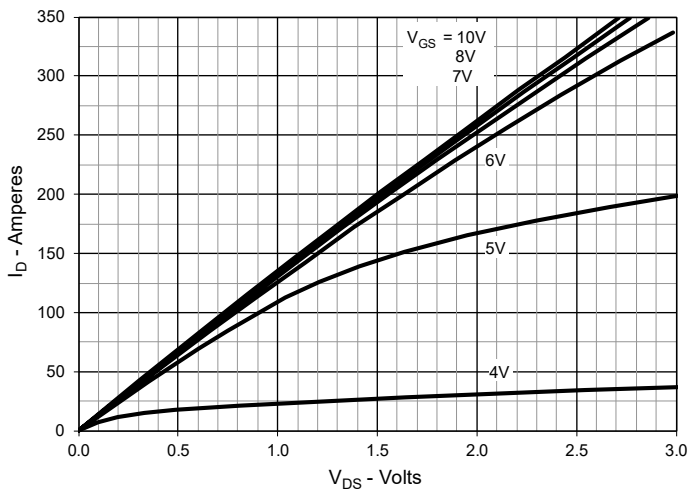

Fig. 4. $R_{DS(on)}$ Normalized to $I_D = 180\text{A}$ Value vs. Junction Temperature

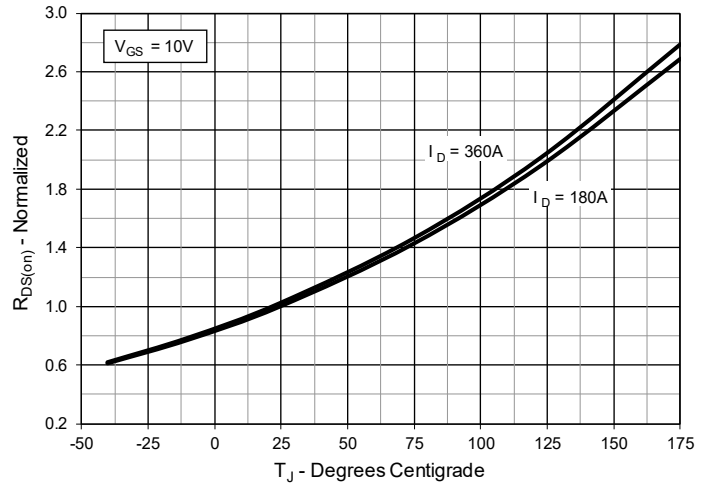

Fig. 5. $R_{DS(on)}$ Normalized to $I_D = 180\text{A}$ Value vs. Drain Current

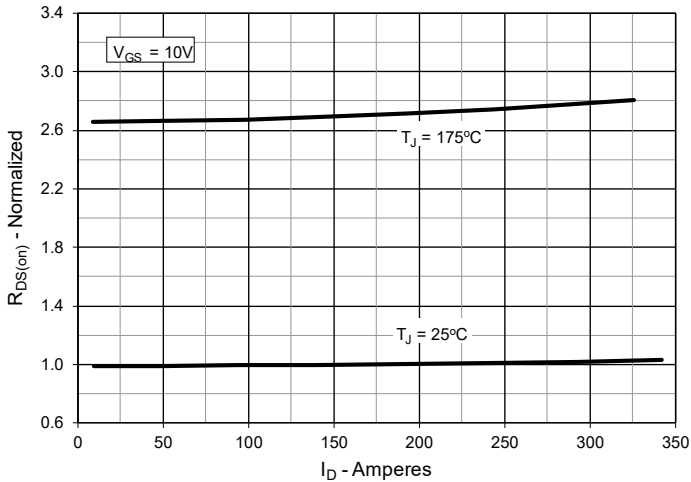

Fig. 6. Drain Current vs. Case Temperature

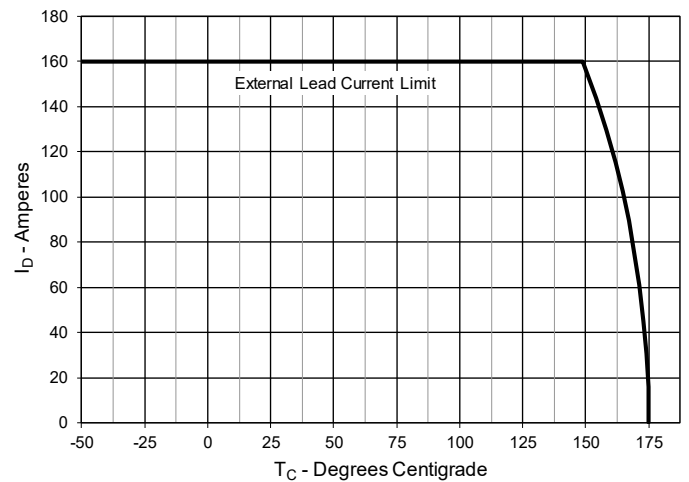

Fig. 7. Input Admittance

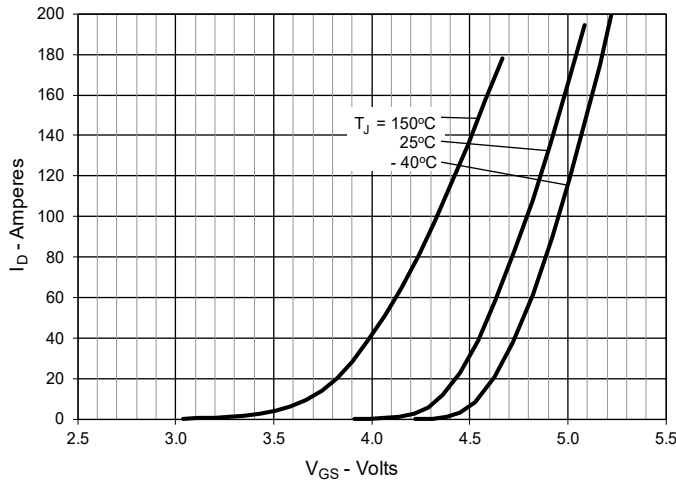

Fig. 8. Transconductance

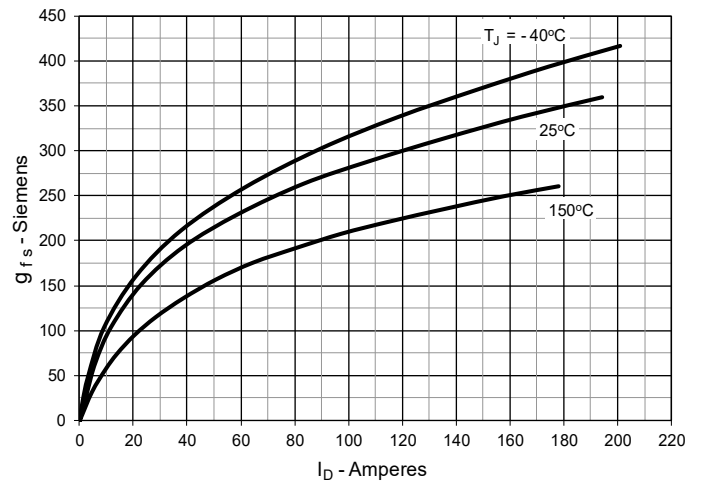

Fig. 9. Forward Voltage Drop of Intrinsic Diode

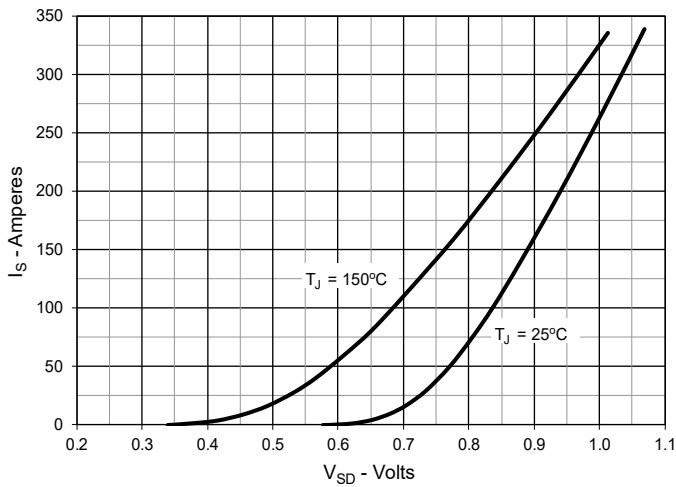

Fig. 10. Gate Charge

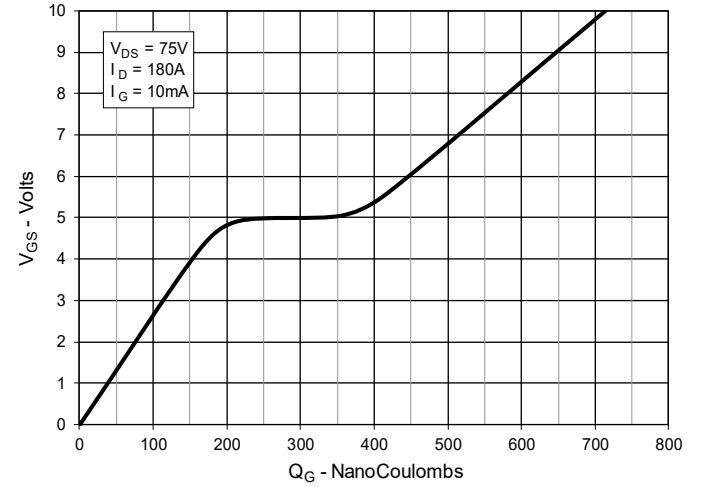

Fig. 11. Capacitance

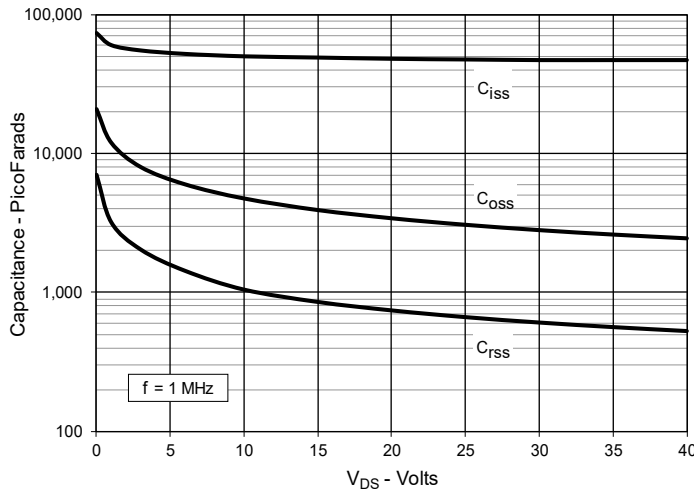
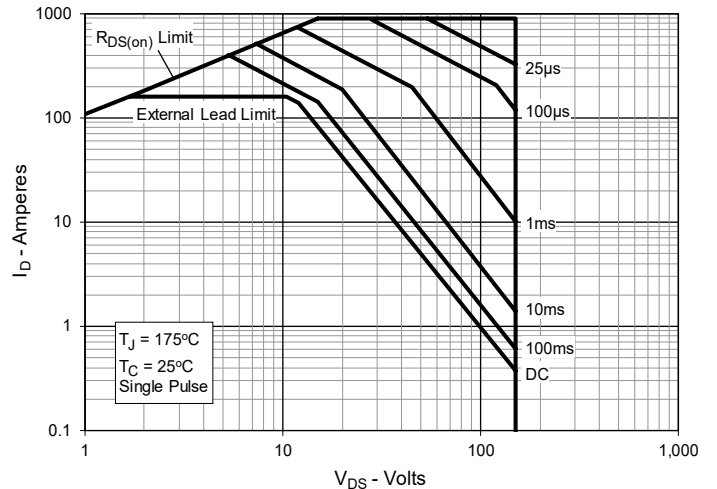
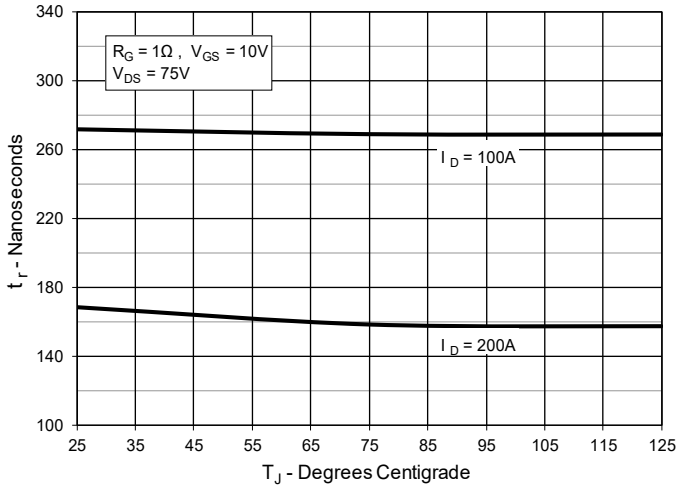

Fig. 12. Forward-Bias Safe Operating Area



**Fig. 13. Resistive Turn-on
Rise Time vs. Junction Temperature**



**Fig. 14. Resistive Turn-on
Rise Time vs. Drain Current**

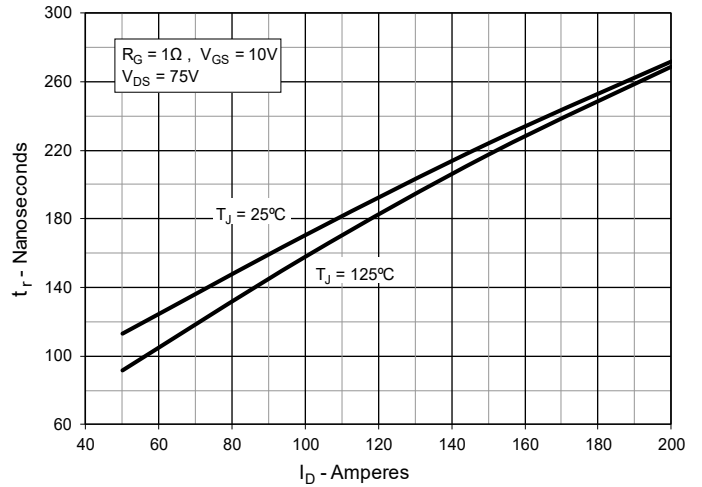

**Fig. 15. Resistive Turn-on
Switching Times vs. Gate Resistance**

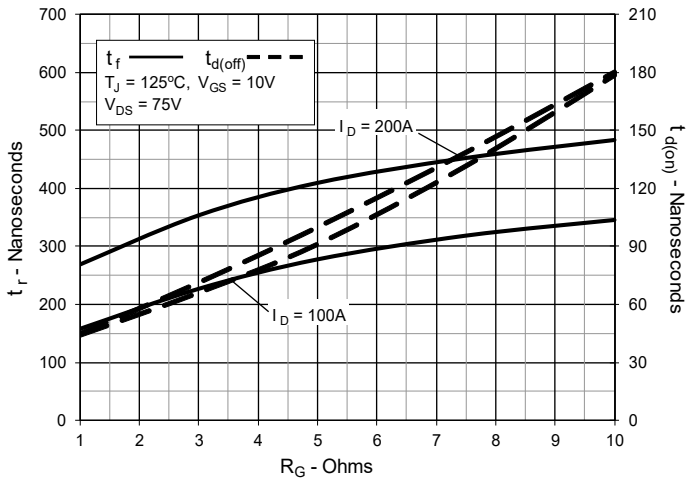

**Fig. 16. Resistive Turn-off
Switching Times vs. Junction Temperature**

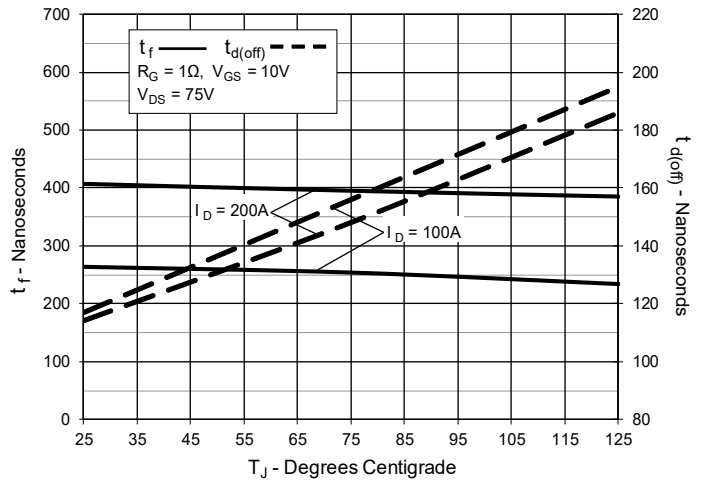

**Fig. 17. Resistive Turn-off
Switching Times vs. Drain Current**

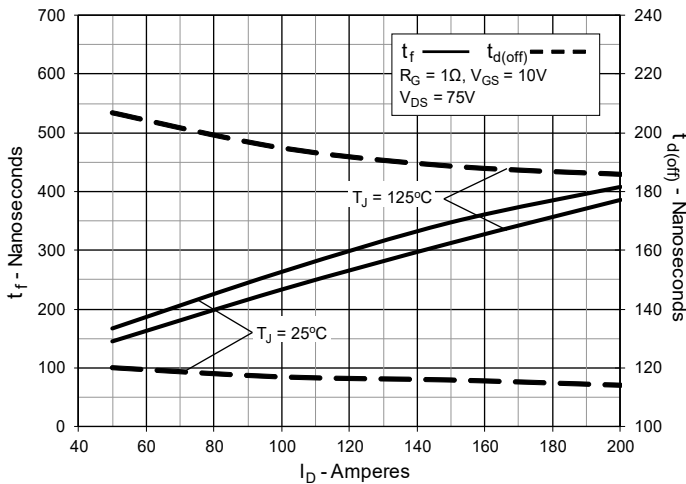

**Fig. 18. Resistive Turn-off
Switching Times vs. Gate Resistance**

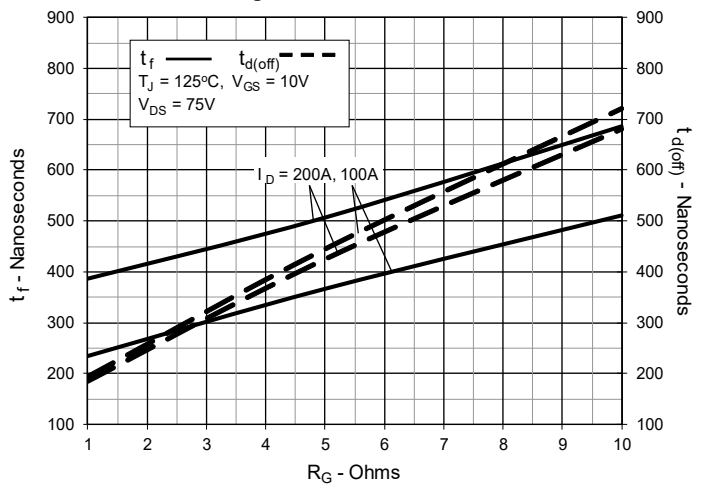
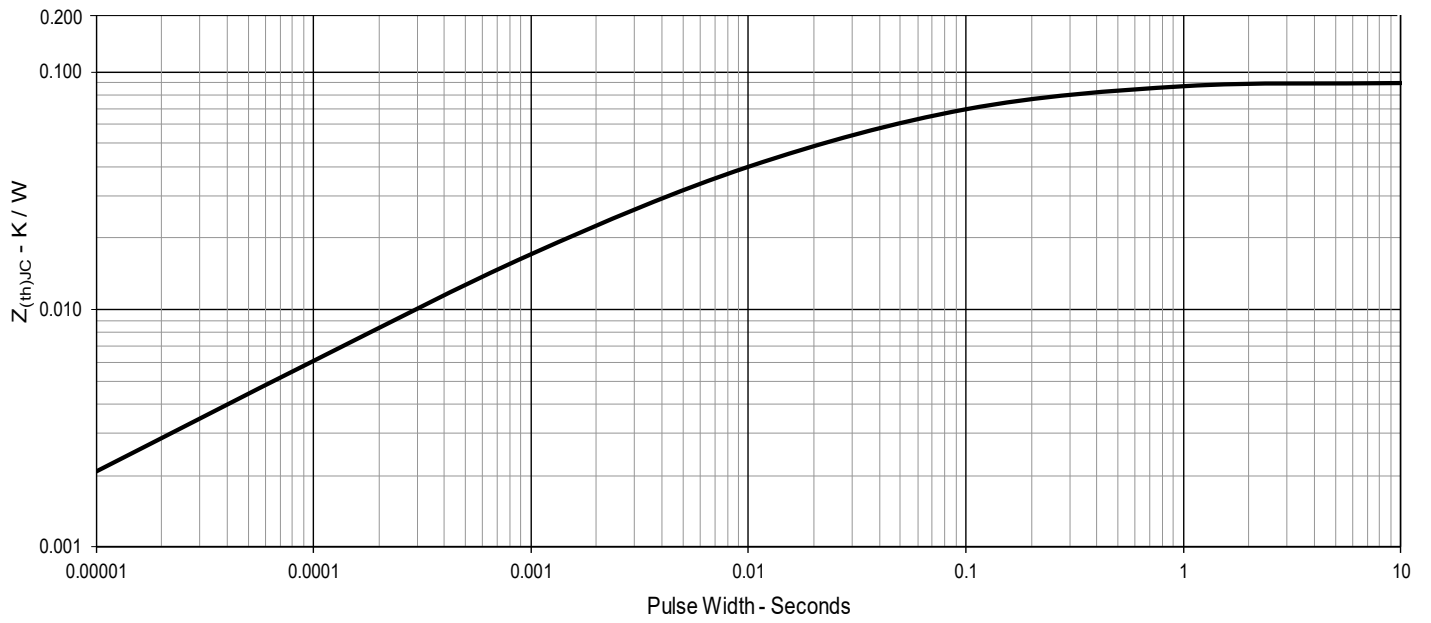
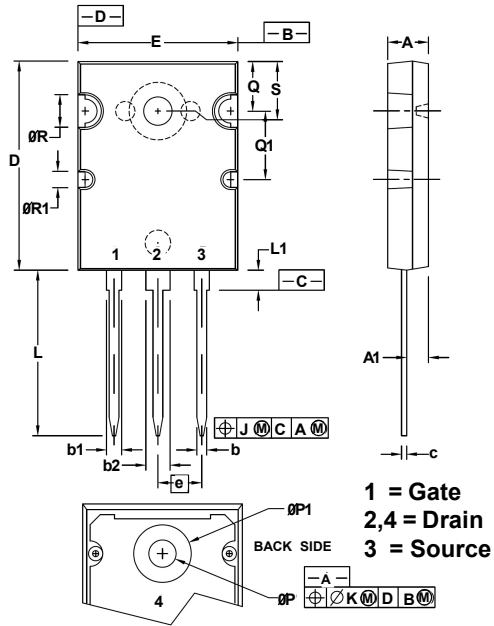

Fig. 19. Maximum Transient Thermal Impedance



TO-264 Outline



SYMBOL	INCHES		MILLIMETERS	
	MIN	MAX	MIN	MAX
A	.185	.209	4.70	5.31
A1	.102	.118	2.59	3.00
b	.037	.055	0.94	1.40
b1	.087	.102	2.21	2.59
b2	.110	.126	2.79	3.20
c	.017	.029	0.43	0.74
D	1.007	1.047	25.58	26.59
E	.760	.799	19.30	20.29
e	.215BSC		5.46 BSC	
J	.000	.010	0.00	0.25
K	.000	.010	0.00	0.25
L	.779	.842	19.79	21.39
L1	.087	.102	2.21	2.59
∅P	.122	.138	3.10	3.51
∅P1	.270	.290	6.86	7.37
Q	.240	.256	6.10	6.50
Q1	.330	.346	8.38	8.79
∅R	.155	.187	3.94	4.75
∅R1	.085	.093	2.16	2.36
S	.243	.253	6.17	6.43

PLUS247™ Outline

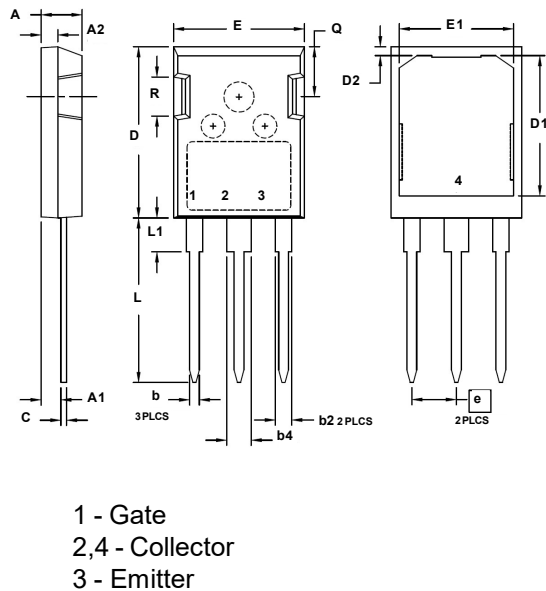

SYM	INCHES		MILLIMETERS	
	MIN	MAX	MIN	MAX
A	.190	.205	4.83	5.21
A1	.090	.100	2.29	2.54
A2	.075	.085	1.91	2.16
b	.045	.055	1.14	1.40
b2	.075	.087	1.91	2.20
b4	.115	.126	2.92	3.20
C	.024	.031	0.61	0.80
D	.819	.840	20.80	21.34
D1	.650	.690	16.51	17.53
D2	.035	.050	0.89	1.27
E	.620	.635	15.75	16.13
E1	.520	.560	13.08	14.22
e	.215 BSC		5.45 BSC	
L	.780	.810	19.81	20.57
L1	.150	.170	3.81	4.32
Q	.220	.244	5.59	6.20
R	.170	.190	4.32	4.83

