

Midget 10x38mm Fuses

KLKD Series

600 V ac/dc • Fast Acting • 1/10–30 A



Description

The KLKD series fast-acting 600 V ac/dc fuses are used in solar combiner boxes and in circuits with dc fault currents up to 50,000 A. These fuses are designed to meet both the UL and IEC photovoltaic fuse specifications and are available in standard and board-mount configurations. The KLKD midget fuses also have high-interrupting and current-limiting capability. They are intended to supplement the primary branch-circuit fuse or breaker to provide backup overcurrent protection. The KLKD fuses are non-indicating and may be used with an indicating fuse block or cover. These fuses are offered in a wide range of ampere ratings to match specific requirements in a variety of applications. Note that 1–5 A meets UL 1741 GFDI requirements.

Features & Benefits

FEATURES	BENEFITS
10x38 mm size	Common dimensions used in a variety of applications
Fast-acting	Provides fast, reliable short-circuit response within the interrupting rating
Mounting options	Available in ferrule or PCB mount
POWR-GARD® technology	Ensures quality backup overcurrent protection
UL & IEC certifications	Certifications to serve the global market

Applications

- Solar combiner boxes
- Inverters
- Power supplies
- Desktop meters

Midget 10x38mm Fuses

KLKD Series

Specifications

Voltage Rating	600 V ac / V dc
Ampere Range	$\frac{1}{10}$ –30 A
Interrupting Ratings	Ac: 100 kA 200 kA Littelfuse self-certified Dc: $\frac{1}{10}$ –30: 10 kA (UL 248-19) $\frac{1}{10}$ –30: 50 kA (UL 248-14)
Applicable Standards	UL 248-14, UL 248-19, UL 1741 GFDI, CSA, IEC 60269-6
Environmental	RoHS Compliant
Material	Body: Melamine Caps: Copper Alloy
Operating Temperature	See Derating Curve
Country of Origin	Mexico

Certification & Compliance

UL	UL Listed (File E339112 and E10480)
CSA	CSA Certified (File: LR29862)
CE	Declaration of Conformity: EU_DOC-KLKD_201105_3_IEC
RoHS	RoHS 2 Directive 2011/65/EU; Directive (EU) 2015/863
VDE*	Certificate No 40033094

*Refer to Ordering Information Table

Accessories

Littelfuse LPSM dead-front series fuse holder (ferrule fuse)
Littelfuse L60030M open-face series fuse holder (ferrule fuse)

Ordering Information (Ferrule Version)

AMPERAGE RATING	CATALOG NUMBER	PRODUCT MARKING	PACKING QUANTITY	ORDERING NUMBER	UPC CODE	AGENCY APPROVALS		
						UL	VDE	CSA
$\frac{1}{10}$	KLKD.100	KLKD $\frac{1}{10}$ A	10	KLKD.100T	07945810189	•		•
			100	KLKD.100H	07945896442	•		•
$\frac{1}{8}$	KLKD.125	KLKD $\frac{1}{8}$ A	10	KLKD.125T	07945810190	•		•
			100	KLKD.125H	07945896443	•		•
$\frac{3}{10}$	KLKD.200	KLKD $\frac{3}{10}$ A	10	KLKD.200T	07945810191	•		•
			100	KLKD.200H	07945896444	•		•
$\frac{1}{4}$	KLKD.250	KLKD $\frac{1}{4}$ A	10	KLKD.250T	07945810192	•		•
			100	KLKD.250H	07945896445	•		•
$\frac{3}{10}$	KLKD.300	KLKD $\frac{3}{10}$ A	10	KLKD.300T	07945810193	•		•
			100	KLKD.300H	07945896446	•		•
$\frac{1}{2}$	KLKD.500	KLKD $\frac{1}{2}$ A	10	KLKD.500T	07945810194	•		•
			100	KLKD.500H	07945896447	•		•
$\frac{3}{4}$	KLKD.750	KLKD $\frac{3}{4}$ A	10	KLKD.750T	07945810195	•		•
			100	KLKD.750H	07945896448	•		•
1	KLKD001	KLKD 1A	10	KLKD001.T	07945810196	•		•
			100	KLKD001.H	07945896449	•		•

Midget 10x38mm Fuses

KLKD Series

Ordering Information (Ferrule Version)

AMPERAGE RATING	CATALOG NUMBER	PRODUCT MARKING	PACKING QUANTITY	ORDERING NUMBER	UPC CODE	AGENCY APPROVALS		
						UL	VDE	CSA
1½	KLKD01.5	KLKD 1-½A	10	KLKD01.5T	07945810197	•		•
			100	KLKD01.5H	07945896450	•		•
2	KLKD002	KLKD 2A	10	KLKD002.T	07945810198	•	•	•
			100	KLKD002.H	07945896451	•	•	•
2½	KLKD02.5	KLKD 2-½A	10	KLKD02.5T	07945810199	•	•	•
			100	KLKD02.5H	07945896452	•	•	•
3	KLKD003	KLKD 3A	10	KLKD003.T	07945810200	•	•	•
			100	KLKD003.H	07945896453	•	•	•
3½	KLKD03.5	KLKD 3½A	10	KLKD03.5T	07945810214	•	•	•
			100	KLKD03.5H	07945896454	•	•	•
4	KLKD004	KLKD 4A	10	KLKD004.T	07945810201	•	•	•
			100	KLKD004.H	07945896455	•	•	•
5	KLKD005	KLKD 5A	10	KLKD005.T	07945810202	•	•	•
			100	KLKD005.H	07945896456	•	•	•
6	KLKD006	KLKD 6A	10	KLKD006.T	07945810203	•	•	•
			100	KLKD006.H	07945896457	•	•	•
7	KLKD007	KLKD 7A	10	KLKD007.T	07945810204	•	•	•
			100	KLKD007.H	07945896458	•	•	•
8	KLKD008	KLKD 8A	10	KLKD008.T	07945810205	•	•	•
			100	KLKD008.H	07945896459	•	•	•
9	KLKD009	KLKD 9A	10	KLKD009.T	07945810215	•	•	•
			100	KLKD009.H	07945896460	•	•	•
10	KLKD010	KLKD 10A	10	KLKD010.T	07945810206	•	•	•
			100	KLKD010.H	07945896461	•	•	•
12	KLKD012	KLKD 12A	10	KLKD012.T	07945810207	•	•	•
			100	KLKD012.H	07945896462	•	•	•
15	KLKD015	KLKD 15A	10	KLKD015.T	07945810208	•	•	•
			100	KLKD015.H	07945896463	•	•	•
20	KLKD020	KLKD 20A	10	KLKD020.T	07945810209	•	•	•
			100	KLKD020.H	07945896464	•	•	•
25	KLKD025	KLKD 25A	10	KLKD025.T	07945810210	•	•	•
			100	KLKD025.H	07945896465	•	•	•
30	KLKD030	KLKD 30A	10	KLKD030.T	07945810211	•		•
			100	KLKD030.H	07945896466	•		•

Ordering Information (PCB 1-Tab Version)

AMPERAGE RATING	CATALOG NUMBER	PRODUCT MARKING	PACKING QUANTITY	ORDERING NUMBER	UPC CODE	AGENCY APPROVALS	
						UL	CSA
¼	KLKD.100R	KLKD ¼A-R	100	KLKD.100HXR	07945814857	•	•
½	KLKD.500R	KLKD ½A-R	100	KLKD500.HXR	07945814858	•	•
1	KLKD001R	KLKD 1A-R	100	KLKD001.HXR	07945812133	•	•
2	KLKD002R	KLKD 2A-R	100	KLKD002.HXR	07945894349	•	•
3	KLKD003R	KLKD 3A-R	100	KLKD003.HXR	07945818991	•	•
4	KLKD004R	KLKD 4A-R	100	KLKD004.HXR	07945811495	•	•

Midget 10x38mm Fuses

KLKD Series

Ordering Information (PCB 1-Tab Version)

AMPERAGE RATING	CATALOG NUMBER	PRODUCT MARKING	PACKING QUANTITY	ORDERING NUMBER	UPC CODE	AGENCY APPROVALS	
						UL	CSA
5	KLKD005R	KLKD 5A-R	100	KLKD005.HXR	07945814859	•	•
6	KLKD006R	KLKD 6A-R	100	KLKD006.HXR	07945894350	•	•
8	KLKD008R	KLKD 8A-R	100	KLKD008.HXR	07945894351	•	•
10	KLKD010R	KLKD 10A-R	100	KLKD010.HXR	07945814860	•	•
12	KLKD012R	KLKD 12A-R	100	KLKD012.HXR	07945894352	•	•
15	KLKD015R	KLKD 15A-R	100	KLKD015.HXR	07945894353	•	•
20	KLKD020R	KLKD 20A-R	100	KLKD020.HXR	07945894354	•	•
25	KLKD025R	KLKD 25A-R	100	KLKD025.HXR	07945894355	•	•
30	KLKD030R	KLKD 30A-R	100	KLKD030.HXR	07945894356	•	•

Electrical Specifications

AMPERAGE RATING	CATALOG NUMBER		VOLTAGE RATING		INTERRUPTING RATING		NOM COLD RESISTANCE (OHMS)	WATTS LOSS AT 100 % RATED CURRENT (W)	WATTS LOSS AT 80 % RATED CURRENT (W)	AVERAGE MELTING I ² T (A ² S)	TOTAL CLEARING I ² T (A ² S) 20 KA @ 600 V DC	TOTAL CLEARING I ² T (A ² S) 100 KA @ 600 V AC
	FERRULE	PCB	AC	DC	AC	DC						
1/10	KLKD.100	KLKD.100R	600	600	200	50	85.5	0.780	0.505	-	0.019	-
1/8	KLKD.125	-	600	600	200	50	65	0.975	0.659	-	0.010	-
3/10	KLKD.200	-	600	600	200	50	30.9	1.213	0.773	-	0.032	-
1/4	KLKD.250	-	600	600	200	50	22	1.364	0.870	-	-	-
3/10	KLKD.300	-	600	600	200	50	16.2	1.519	0.960	-	0.067	-
1/2	KLKD.500	KLKD.500R	600	600	200	50	8.16	1.961	1.237	-	0.197	-
3/4	KLKD.750	-	600	600	200	50	0.402	0.361	1.990	0.234	0.754	0.420
1	KLKD001	KLKD001R	600	600	200	50	0.252	0.388	0.273	0.678	1.8	0.983
1 1/2	KLKD01.5	-	600	600	200	50	0.134	0.409	0.229	2.9	-	3.8
2	KLKD002	KLKD002R	600	600	200	50	0.129	0.823	0.606	2.4	3.9	3.5
2 1/2	KLKD02.5	-	600	600	200	50	0.0989	0.912	0.618	5.1	8.9	7.5
3	KLKD003	KLKD003R	600	600	200	50	0.0773	0.957	0.654	7.8	15	13
3 1/2	KLKD03.5	-	600	600	200	50	0.0613	1.120	0.826	12	21	20
4	KLKD004	KLKD004R	600	600	200	50	0.0511	1.367	0.891	19	31	28
5	KLKD005	KLKD005R	600	600	200	50	0.0363	1.400	0.938	34	57	52
6	KLKD006	KLKD006R	600	600	200	50	0.0261	1.516	0.998	63	97	97
7	KLKD007	-	600	600	200	50	0.0205	1.577	1.066	105	169	159
8	KLKD008	KLKD008R	600	600	200	50	0.0194	1.824	1.205	130	211	199
9	KLKD009	-	600	600	200	50	0.0166	2.208	1.428	164	267	251
10	KLKD010	KLKD010R	600	600	200	50	0.0128	1.893	1.300	278	455	421
12	KLKD012	KLKD012R	600	600	200	50	0.0103	2.296	1.584	445	745	652
15	KLKD015	KLKD015R	600	600	200	50	0.007855	2.045	1.570	137	351	419
20	KLKD020	KLKD020R	600	600	200	50	0.0045	2.133	15.930	462	1151	1232
25	KLKD025	KLKD025R	600	600	200	50	0.003532	2.550	1.933	835	1744	2190
30	KLKD030	KLKD030R	600	600	200	50	0.002776	3.701	1.983	1409	2757	3220

Midget 10x38mm Fuses

KLKD Series

Electrical Specification - Agency Requirements

AMPERAGE RATING	OPENING TIME (MINUTES)			
	100 % OF AMPERE RATING PER UL	105 % OF AMPERE RATING PER IEC	135 % OF AMPERE RATING PER UL	200 % OF AMPERE RATING PER UL
1/10-30	Temperature Stabilization	60 min	60 max	2 max

Dimensions Inches (mm)

FERRULE VERSION

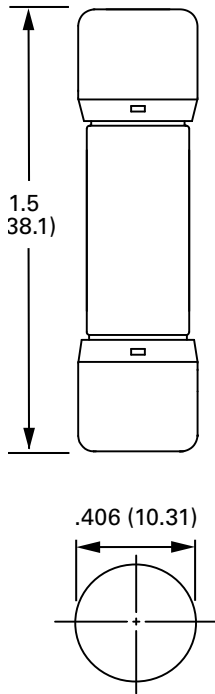

PCB 1-TAB

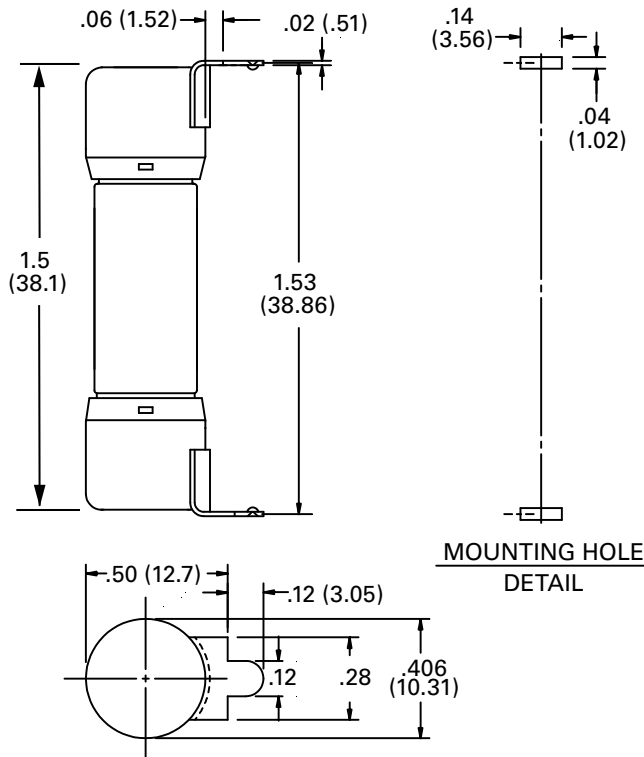

MOUNTING HOLE
DETAIL

Midget 10x38mm Fuses

KLKD Series

Temperature Derating Curve

Ambient temperature: temperature of air immediately surrounding fuse

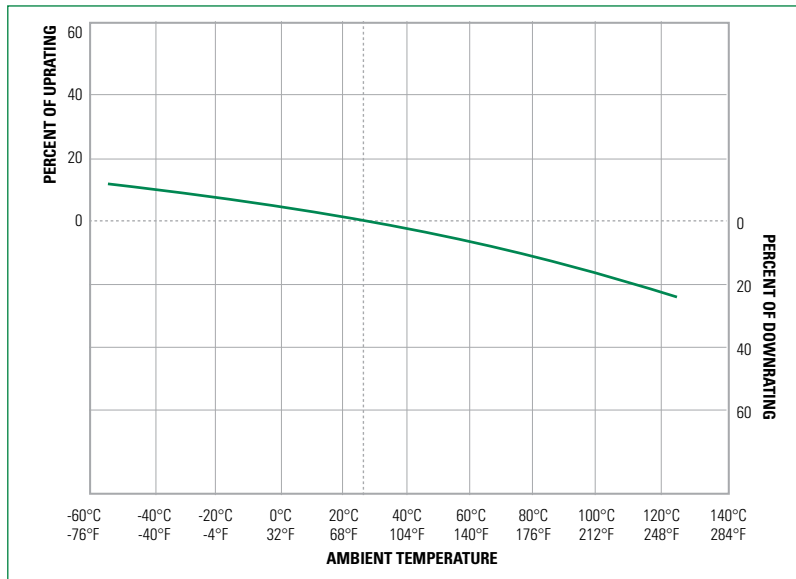

Current-Limiting Effects

SHORT CIRCUIT CURRENT*	APPARENT RMS SYMMETRICAL CURRENT FOR VARIOUS FUSE RATINGS			
	1 1/2 A	12 A	25 A	30 A
5,000	240	292	654	722
10,000	303	367	823	910
15,000	347	420	943	1042
20,000	381	463	1037	1147
25,000	411	498	1117	1235
30,000	437	530	1188	1313
35,000	460	558	1250	1382
40,000	481	583	1307	1445
50,000	518	628	1408	1556
60,000	550	667	1496	1654
80,000	605	735	1647	1820
100,000	652	791	1774	1961

*Prospective RMS Symmetrical Amperes Short-Circuit Current

Midget 10x38mm Fuses

KLKD Series

Recommended Process and Soldering Parameters

WAVE PARAMETER	LEAD FREE RECOMMENDATION
Preheat:	(Typical Industry Recommendation)
Temperature Minimum:	130 °C
Temperature Maximum:	—
Pre-heat Time	75 Seconds Maximum
Solder Pot Temperature	280 °C Maximum
Solder Dwell Time	270 °C for 8 Seconds Maximum
Complete Cycle Time	250 Seconds Maximum

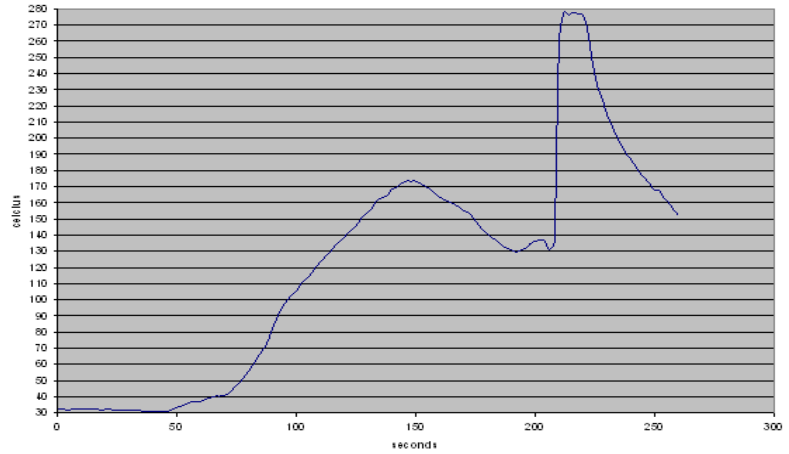

Peak Let-Thru Curve

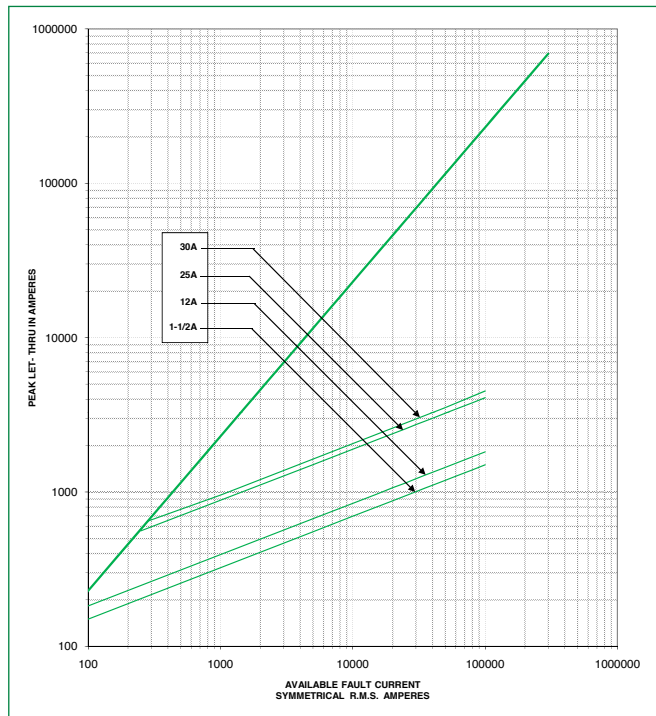

Midget 10x38mm Fuses

KLKD Series

Time Current Curves

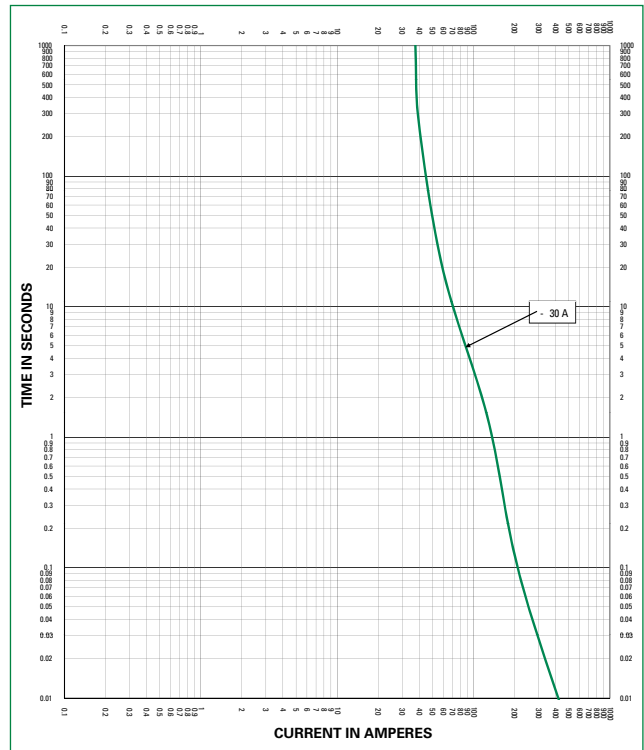
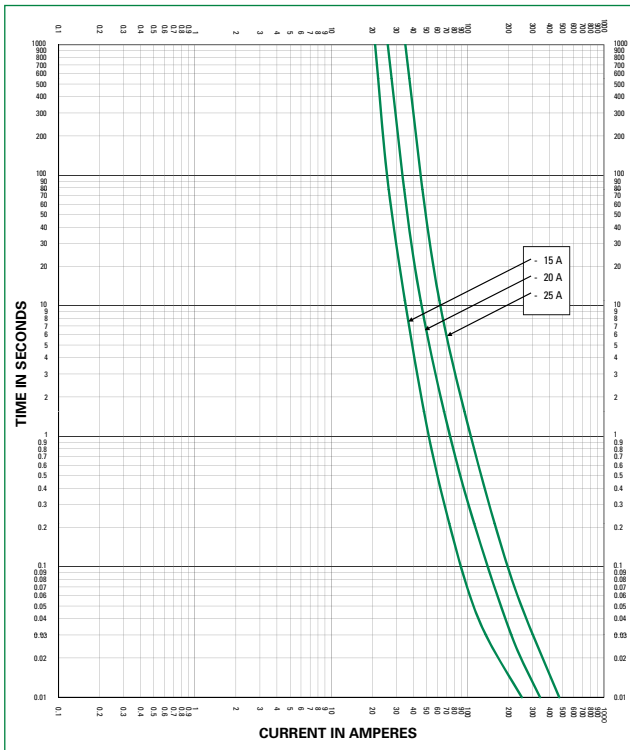
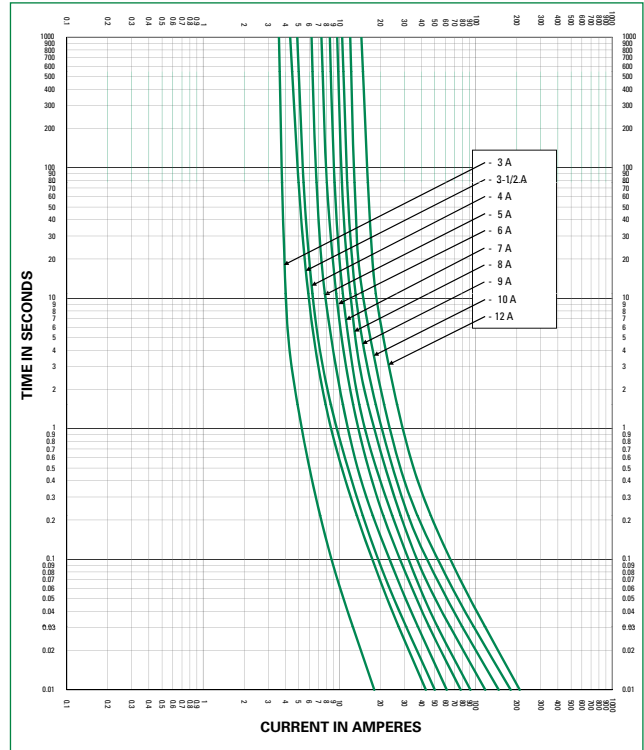
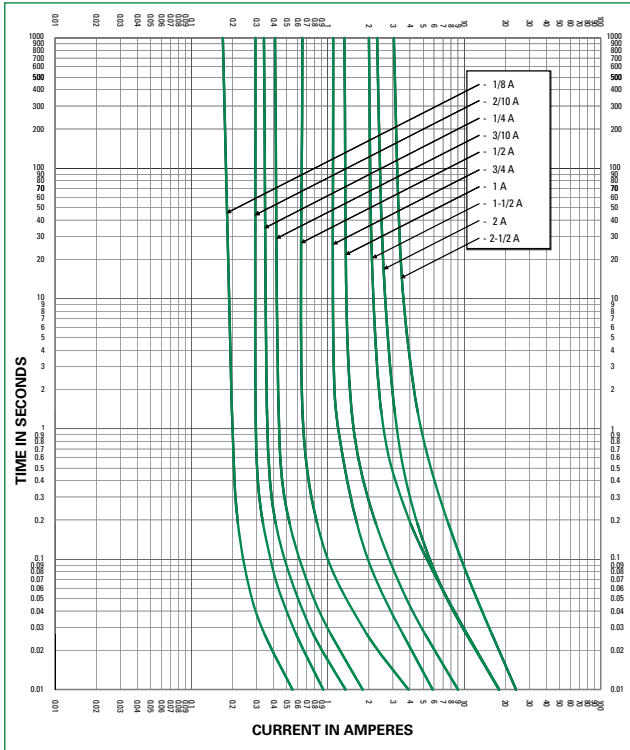

Disclaimer Notice – Information furnished is believed to be accurate and reliable. However, users should independently evaluate the suitability of and test each product selected for their own applications. Littelfuse products are not designed for, and may not be used in, all applications. Read complete Disclaimer Notice at www.littelfuse.com/product-disclaimer.