

# KSPD SERIES

## Solid State Timer

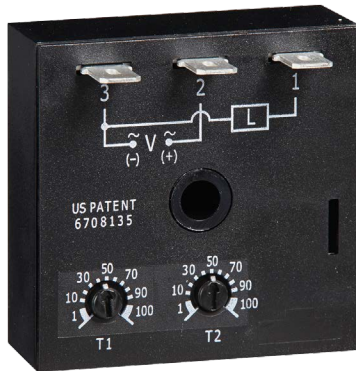

### Description

The KSPD Series is a factory programmed module available with 1 of 12 standard dual functions. The time delays can be factory fixed, externally or onboard adjustable, or a combination of fixed and adjustable. The 1A steady, 10A inrush rated solid-state output provides 100 million operations, typical. Its microcontroller timing circuit provides excellent repeat accuracy and stability. Encapsulation protects against shock, vibration, and humidity. The KSPD Series is a cost effective approach for OEM applications that require small size and long life.

### Features & Benefits

FEATURES	BENEFITS
<b>Microcontroller based</b>	Repeat Accuracy + / - 0.5%
<b>Compact design</b>	Allows flexibility for OEM applications
<b>1A steady, 10A inrush solid-state output</b>	Provides 100 million operations in typical conditions.
<b>Totally solid state and encapsulated</b>	No moving parts to arc and wear out over time and encapsulated to protect against shock, vibration, and humidity

### Wiring Diagram

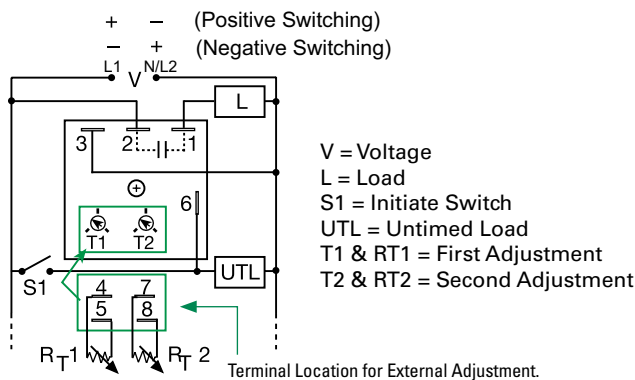

### Accessories

- 

**P1004-95, P1004-95-X Versa-Pot**  
Panel mountable, industrial potentiometer recommended for remote time delay adjustment.
- 

**P1023-6 Mounting bracket**  
The 90° orientation of mounting slots makes installation/removal of modules quick and easy.
- 

**P0700-7 Versa-Knob**  
Designed for 0.25 in. (6.35 mm) shaft of Versa-Pot. Semi-gloss industrial black finish.
- 

**P1015-64 (AWG 14/16) Female Quick Connect**  
These 0.25 in. (6.35 mm) female terminals are constructed with an insulator barrel to provide strain relief.
- 

**C103PM (AL) DIN Rail**  
35 mm aluminum DIN rail available in a 36 in. (91.4 cm) length.
- 

**P1023-20 DIN Rail Adapter**  
Allows module to be mounted on a 35 mm DIN type rail with two #10 screws.

### Ordering Information

MODEL	INPUT	ADJUSTMENT 1	TIME DELAY 1	ADJUSTMENT 2	TIME DELAY 2	FUNCTION
KSPDA2222RXE	24 to 240VAC	Onboard	1-100s	Onboard	1-100s	Recycling/On Time First
KSPDP110M18SRXE	12 to 120VDC positive switching	Fixed	10 mins	Fixed	8s	Recycling/On Time First

If you don't find the part you need, call us for a custom product 800-843-8848

# KSPD SERIES

## Function Diagrams

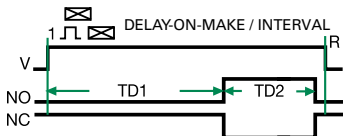
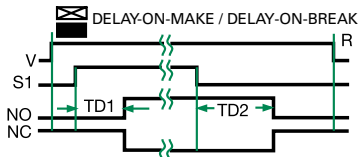
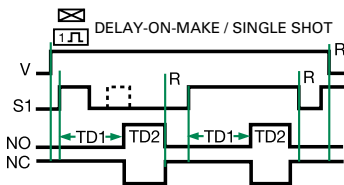
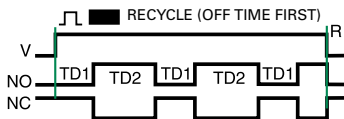
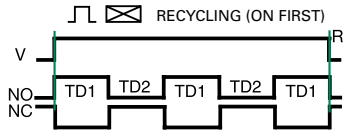

V = Voltage  
S1 = Initiate Switch  
NO = Normally Open Contact  
NC = Normally Closed Contact  
TD1, TD2 = Time Delay  
R = Reset  
— = Undefined Time

## Specifications

### Time Delay

**Type**  
**Range**

Microcontroller circuitry  
0.1s - 1000h in 9 adjustable ranges or fixed (to 999)

**Repeat Accuracy Tolerance (Factory Calibration)**

±0.5% or 20ms, whichever is greater

**Reset Time**

≤ ±2%

**Initiate Time**

≤ 150ms

**Time Delay vs Temp. & Voltage**

≤ 20ms; ≤ 1500 operations per minute

### Input

**Voltage**

12 to 120VDC; 24 to 240VAC

**Tolerance**

≤ ±15%

**AC Line Frequency/DC Ripple**

50/60Hz / ≤ 10%

**Power Consumption**

AC ≤ 2VA; DC ≤ 1W

### Output

**Type**

Solid-state output

**Rating**

1A steady, 10A inrush for 16ms

**Voltage Drop**

AC ≅ 2.5V @ 1A; DC ≅ 1V @ 1A

**OFF State Leakage Current**

AC ≅ 5mA @ 230VAC; DC ≅ 1mA

### Protection

**Circuitry**

Encapsulated

**Dielectric Breakdown**

≥ 2000V rms terminals to mounting surface

**Insulation Resistance**

≥ 100 MΩ

**Polarity**

DC units are reverse polarity protected

### Mechanical

**Mounting**

Surface mt. with one #10 (M5 x 0.8) screw

**Dimensions**

**H** 50.8 mm (2"); **W** 50.8 mm (2");

**D** 30.7 mm (1.21")

**Termination**

0.25 in. (6.35 mm) male quick connects

### Environmental

**Operating/Storage**

-40° to 60°C / -40° to 85°C

**Temperature**

95% relative, non-condensing

**Humidity**

≅ 2.4 oz (68 g)

**Weight**