

Parameter	Ratings	Units
Blocking Voltage	350	V_P
Load Current	120	mA_{rms} / mA_{DC}
On-Resistance (max)	25	Ω

Features

- 3750V_{rms} Input/Output Isolation
- Low Drive Power Requirements
- Higher Reliability than Electromechanical Relays
- FCC Compatible
- VDE Compatible
- No EMI/RFI Generation
- Small 8-Pin Package
- Flammability Rating UL 94 V-0
- Surface Mount Tape & Reel Version Available

Applications

- Telecommunications
 - Telecom Switching
 - Tip/Ring Circuits
 - Modem Switching (Laptop, Notebook, Pocket Size)
 - Hook Switch
 - Dial Pulsing
 - Ground Start
 - Ringing Injection
- Instrumentation
- Multiplexers
- Data Acquisition
- Electronic Switching
- I/O Subsystems
- Meters (Watt-Hour, Water, Gas)
- Medical Equipment—Patient/Equipment Isolation
- Security
- Industrial Controls

Description

The LAA100 is a 350V, 120mA, dual single-pole, normally open (1-Form-A) relay featuring low, 25 Ω , maximum on-resistance.

Approvals

- UL Recognized Component: File # E76270
- CSA Certified Component: Certificate # 1175739
- TUV EN 62368-1: Certificate # B 082667 0008

Ordering Information

Part #	Description
LAA100	8 Pin DIP (50/Tube)
LAA100P	8-Pin Flatpack (50/Tube)
LAA100PTR	8-Pin Flatpack (1000/Reel)
LAA100S	8-Pin Surface Mount (50/Tube)
LAA100STR	8-Pin Surface Mount (1,000/Reel)

Pin Configuration

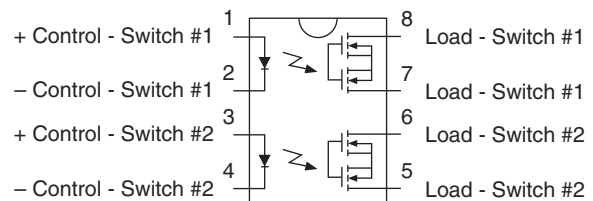

Switching Characteristics of Normally Open (Form A) Devices

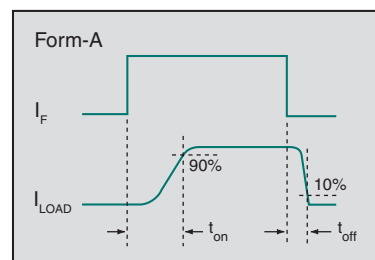

Absolute Maximum Ratings @25°C

Parameter	Ratings	Units
Blocking Voltage	350	V _P
Reverse Input Voltage	5	V
Input Control Current Peak (10ms)	50	mA
	1	A
Input Power Dissipation ¹	150	mW
Total Power Dissipation ²	800	mW
Isolation Voltage, Input to Output	3750	V _{rms}
Operational Temperature, Ambient	-40 to +85	°C
Storage Temperature	-40 to +125	°C

¹ Derate linearly 1.33 mW / °C

² Derate output power linearly 6.67 mW / °C

Absolute Maximum Ratings are stress ratings. Stresses in excess of these ratings can cause permanent damage to the device. Functional operation of the device at conditions beyond those indicated in the operational sections of this data sheet is not implied.

Typical values are characteristic of the device at +25°C, and are the result of engineering evaluations. They are provided for information purposes only, and are not part of the manufacturing testing requirements.

Electrical Characteristics @ 25°C

Parameter	Conditions	Symbol	Min	Typ	Max	Units
Output Characteristics						
Blocking Voltage	I _L =1μA	V _{DRM}	350	-	-	V
Load Current Continuous ¹ Peak	-	I _L	-	-	120	mA _{rms} / mA _{DC}
	10ms	I _{LPK}	-	-	±350	mA _P
On-Resistance ²	I _L =120mA	R _{ON}	-	-	25	Ω
Off-State Leakage Current	V _L =350V	I _{LEAK}	-	-	1	μA
Switching Speeds						
Turn-On	I _F = 5mA, V _L = 10V	t _{on}	-	-	5	ms
Turn-Off		t _{off}	-	-	5	ms
Output Capacitance	I _F =0mA, V _L = 50V, f=1MHz	C _{OUT}	-	35	-	pF
Input Characteristics						
Input Control Current to Activate	I _L = 120mA	I _F	-	-	5	mA
Input Control Current to Deactivate	-	I _F	0.4	0.7	-	mA
Input Voltage Drop	I _F = 5mA	V _F	0.9	1.36	1.5	V
Reverse Input Current	V _R = 5V	I _R	-	-	10	μA
Common Characteristics						
Capacitance Input to Output	V _{IO} =0V, f=1MHz	C _{IO}	-	3	-	pF

¹ If both poles operate, the load current must be derated so that the package power dissipation value is not exceeded.

² Measurement taken within 1 second of on-time.

PERFORMANCE DATA*

Typical LED Forward Voltage Drop
(N=50, $I_F=5mA$)

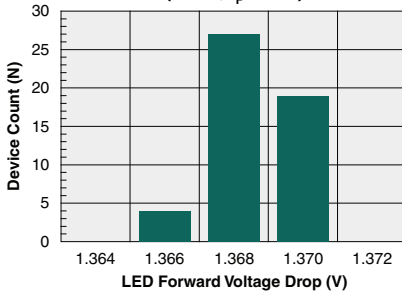

Typical Turn-On Time
(N=50, $T_A=25^\circ C$, $I_L=120mA_{DC}$, $I_F=5mA$)

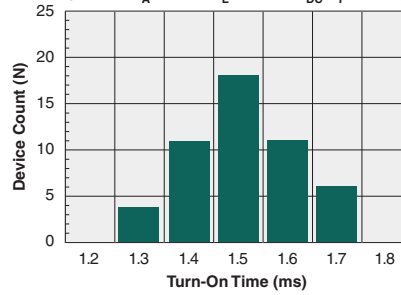

Typical Turn-Off Time
(N=50, $T_A=25^\circ C$, $I_L=120mA_{DC}$, $I_F=5mA$)

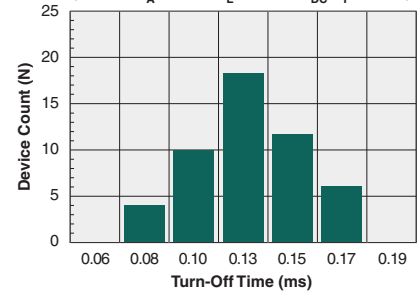

Typical I_F for Switch Operation
(N=50, $T_A=25^\circ C$, $I_L=120mA_{DC}$)

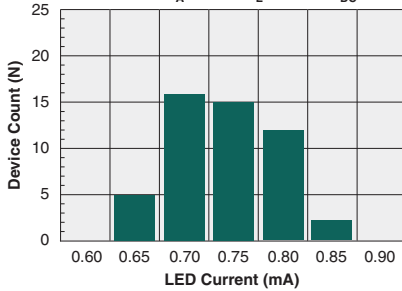

Typical I_F for Switch Dropout
(N=50, $T_A=25^\circ C$, $I_L=120mA_{DC}$)

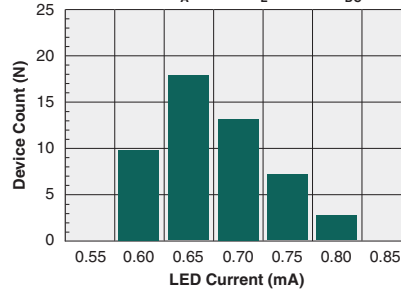

Typical On-Resistance Distribution
(N=50, $T_A=25^\circ C$, $I_L=120mA_{DC}$)

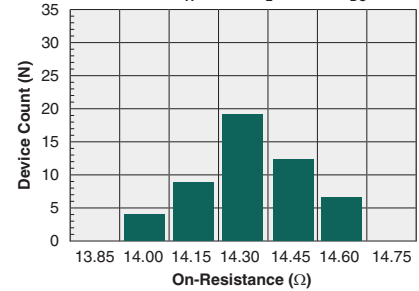

Typical Blocking Voltage Distribution
(N=50, $T_A=25^\circ C$)

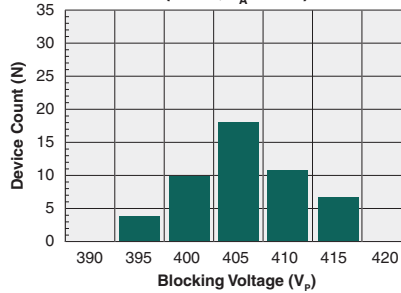

Typical LED Forward Voltage Drop vs. Temperature

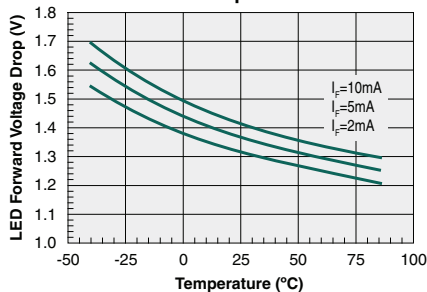

Typical Turn-On Time vs. LED Forward Current
($T_A=25^\circ C$, $I_L=120mA_{DC}$)

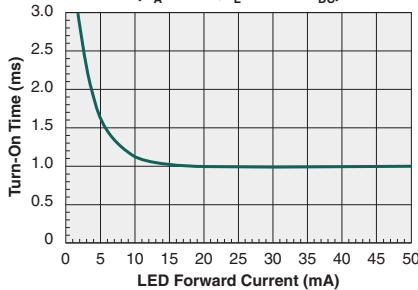

Typical Turn-Off Time vs. LED Forward Current
($T_A=25^\circ C$, $I_L=120mA_{DC}$)

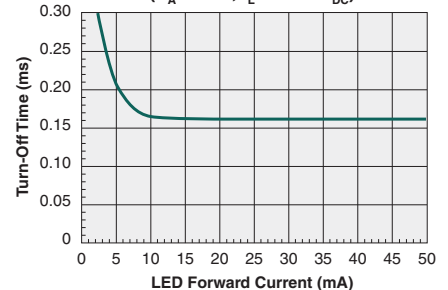

*Unless otherwise noted, data presented in these graphs is typical of device operation at 25°C.

PERFORMANCE DATA*

Typical I_F for Switch Operation vs. Temperature ($I_L=70mA_{DC}$)

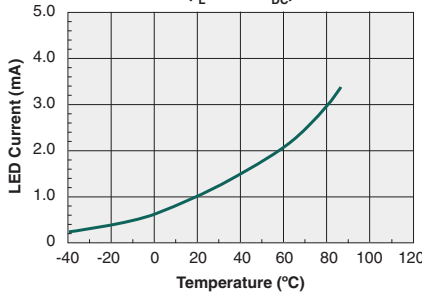

Typical Turn-On Time vs. Temperature ($I_L=70mA_{DC}$)

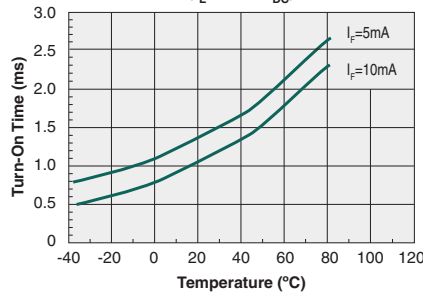

Typical On-Resistance vs. Temperature ($I_L=120mA_{DC}$, One Pole Operating)

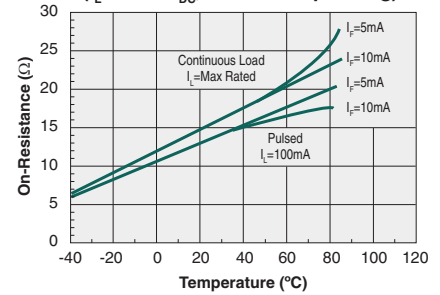

Typical I_F for Switch Dropout vs. Temperature ($I_L=70mA_{DC}$)

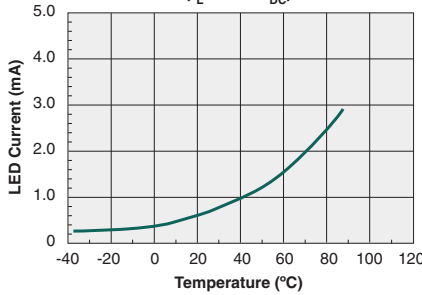

Typical Turn-Off Time vs. Temperature ($I_L=70mA_{DC}$)

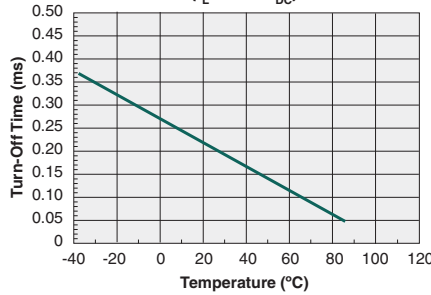

Typical On-Resistance vs. Temperature ($I_L=120mA_{DC}$, Both Poles Operating)

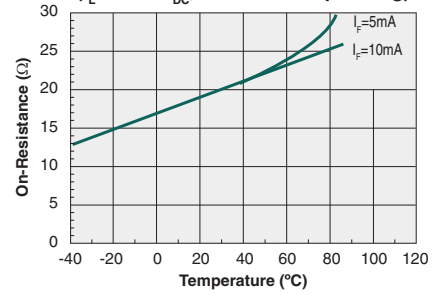

Maximum Continuous DC Load Current vs. Temperature

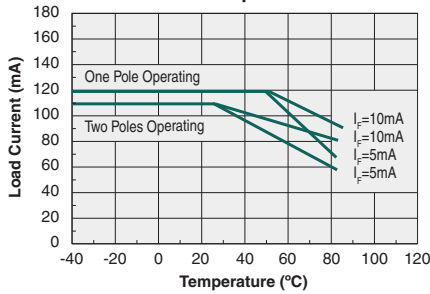

Typical Load Current vs. Load Voltage ($T_A=25°C$, $I_F=5mA$)

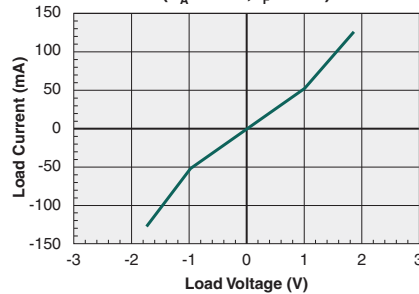

Typical Blocking Voltage vs. Temperature

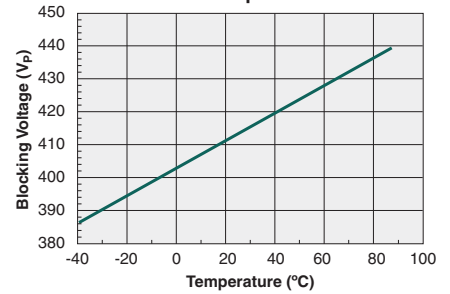

Typical Leakage vs. Temperature Measured across Pins 5&6, 7&8 ($V_L=350V$)

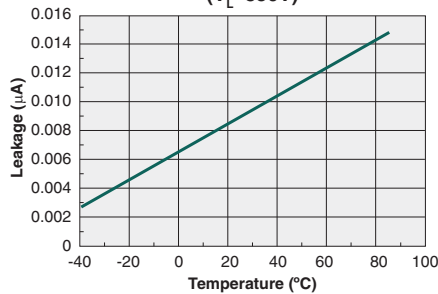

Energy Rating Curve

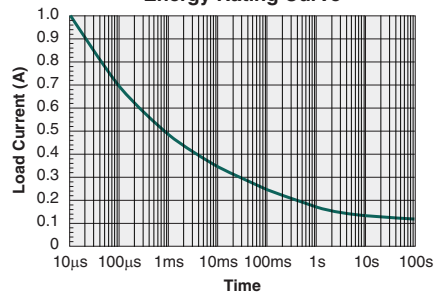

*Unless otherwise noted, data presented in these graphs is typical of device operation at 25°C.

Manufacturing Information

Moisture Sensitivity



All plastic encapsulated semiconductor packages are susceptible to moisture ingress. IXYS Integrated Circuits classifies its plastic encapsulated devices for moisture sensitivity according to the latest version of the joint industry standard, **IPC/JEDEC J-STD-020**, in force at the time of product evaluation. We test all of our products to the maximum conditions set forth in the standard, and guarantee proper operation of our devices when handled according to the limitations and information in that standard as well as to any limitations set forth in the information or standards referenced below.

Failure to adhere to the warnings or limitations as established by the listed specifications could result in reduced product performance, reduction of operable life, and/or reduction of overall reliability.

This product carries a **Moisture Sensitivity Level (MSL)** classification as shown below, and should be handled according to the requirements of the latest version of the joint industry standard **IPC/JEDEC J-STD-033**.

Device	Moisture Sensitivity Level (MSL) Classification
LAA100S / LAA100P	MSL 1

ESD Sensitivity



This product is ESD Sensitive, and should be handled according to the industry standard **JESD-625**.

Soldering Profile

Provided in the table below is the **IPC/JEDEC J-STD-020** Classification Temperature (T_C) and the maximum dwell time the body temperature of these surface mount devices may be ($T_C - 5$)°C or greater. The Classification Temperature sets the Maximum Body Temperature allowed for these devices during reflow soldering processes.

Device	Classification Temperature (T_C)	Dwell Time (t_p)	Max Reflow Cycles
LAA100S	250°C	30 Seconds	3
LAA100P	260°C	30 seconds	3

For through-hole devices, the maximum pin temperature and maximum dwell time through all solder waves is provided in the table below. Dwell time is the interval beginning when the pins are initially immersed into the solder wave until they exit the solder wave. For multiple waves, the dwell time is from entering the first wave until exiting the last wave. During this time, pin temperatures must not exceed the maximum temperature given in the table below. Body temperature of the device must not exceed the limit shown in the table below at any time during the soldering process.

Device	Maximum Pin Temperature	Maximum Body Temperature	Maximum Dwell Time	Wave Cycles
LAA100	260°C	250°C	10 seconds*	1

*Total cumulative duration of all waves.

Board Wash

IXYS Integrated Circuits recommends the use of no-clean flux formulations. Board washing to reduce or remove flux residue following the solder reflow process is acceptable provided proper precautions are taken to prevent damage to the device. These precautions include but are not limited to: using a low pressure wash and providing a follow up bake cycle sufficient to remove any moisture trapped within the device due to the washing process. Due to the variability of the wash parameters used to clean the board, determination of the bake temperature and duration necessary to remove the moisture trapped within the package is the responsibility of the user (assembler). Cleaning or drying methods that employ ultrasonic energy may damage the device and should not be used. Additionally, the device must not be exposed to halide flux or solvents.



MECHANICAL DIMENSIONS

LAA100

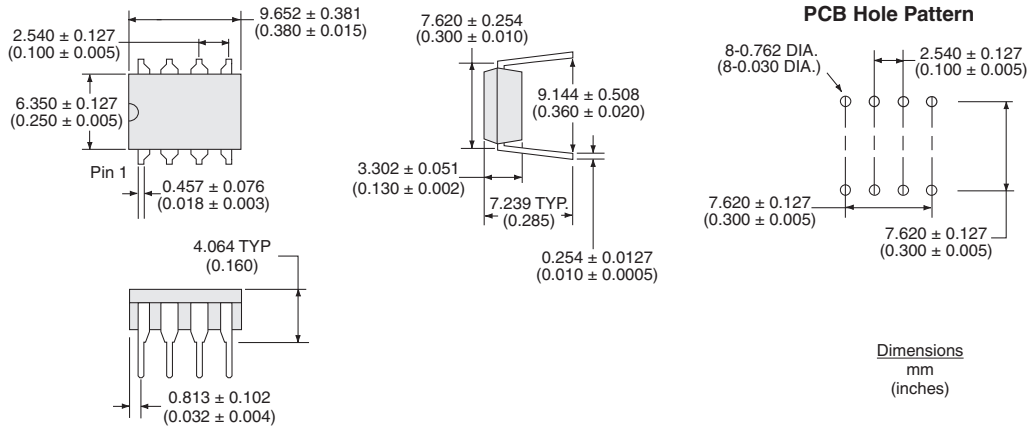

LAA100S

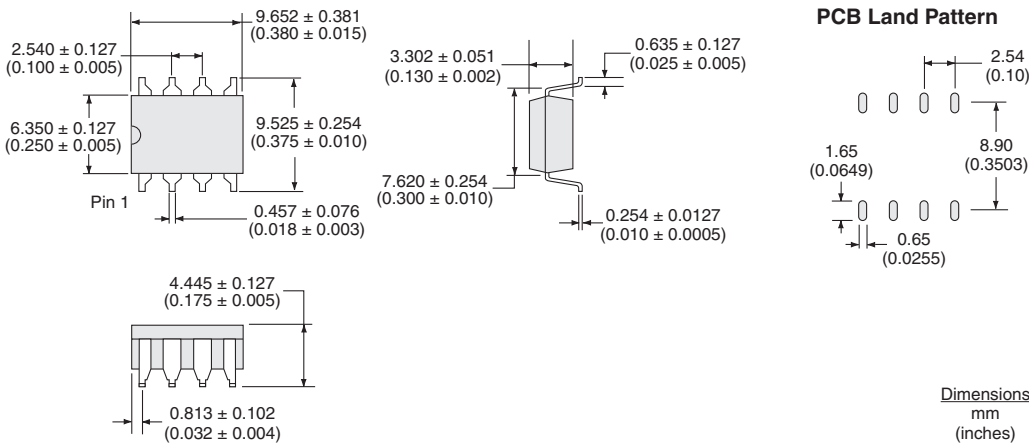

LAA100P

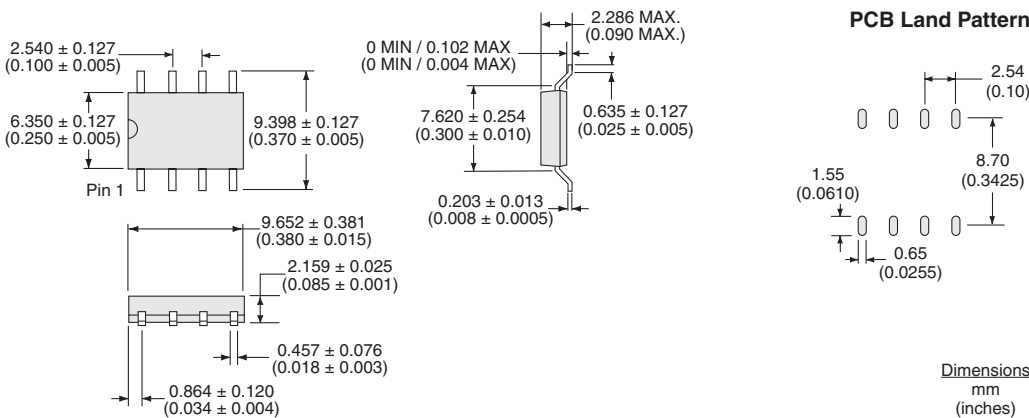

LAA100STR Tape & Reel

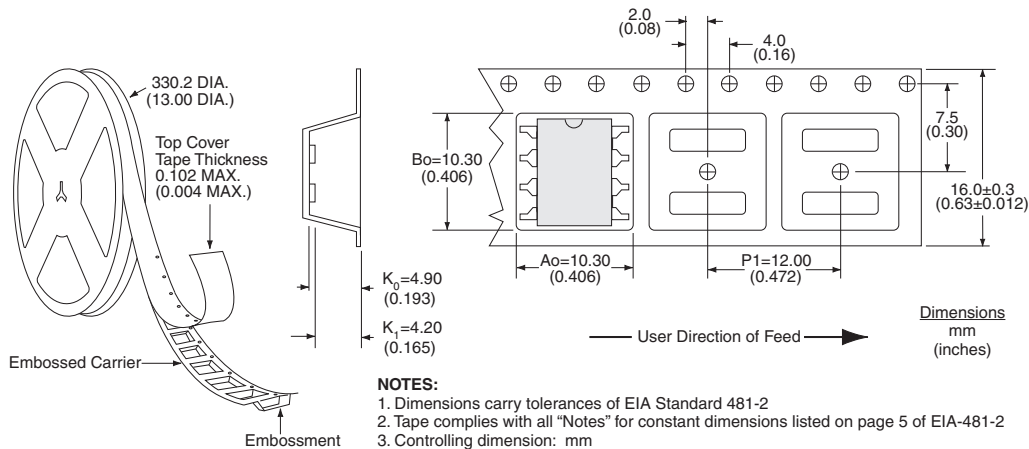

LAA100PTR Tape & Reel

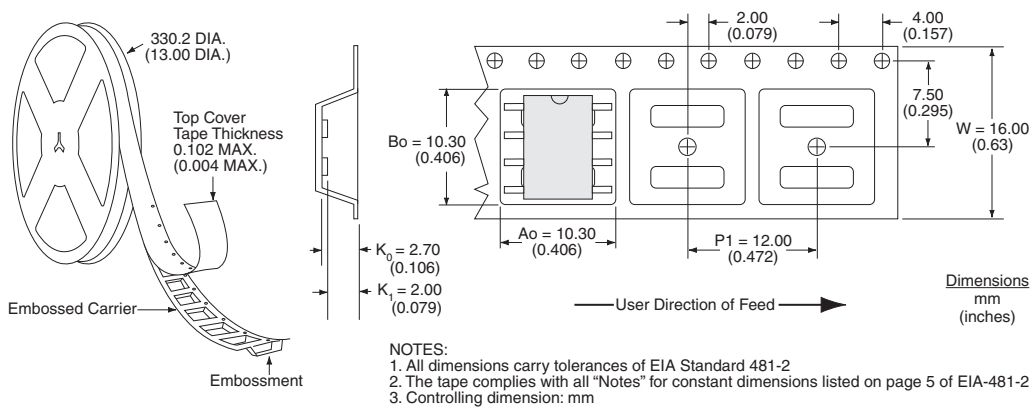

For additional information please visit our website at: <https://www.ixysic.com>