

| Parameter | Ratings | Units |
|---------------------|-----------|----------------------|
| Blocking Voltage | 350 | V_P |
| Load Current | ± 120 | mA_{rms} / mA_{DC} |
| On-Resistance (max) | 35 | Ω |

Features

- 3750V_{rms} Input/Output Isolation
- Normally Open Relay is a Current-Limiting Device
- Low Drive Power Requirements
- Greater Reliability than Electromechanical Relays
- No EMI/RFI Generation
- Small 8-Pin Package
- Flammability Rating UL 94 V-0
- Surface Mount Tape & Reel Versions Available

Applications

- Telecommunications
- Instrumentation
- Multiplexers
- Data Acquisition
- Electronic Switching
- I/O Subsystems
- Meters (Watt-Hour, Water, Gas)
- Medical Equipment-Patient/Equipment Isolation
- Security
- Industrial Controls

Description

LBA110L is a combination device comprising one normally open (1-Form-A) and one normally closed (1-Form-B) solid state relays. Both relays are independent, 350V, 120mA, 35 Ω devices designed to provide an ideal solution where a complementary relay pair (1-Form-A / 1-Form-B) is required.

The normally open (1-Form-A) relay is configured as a current-limiting device.

Approvals

- UL Recognized Component: File # E76270
- CSA Certified Component: Certificate # 1175739
- TUV EN 62368-1: Certificate # B 082667 0008

Ordering Information

| Part # | Description |
|------------|-----------------------------------|
| LBA110L | 8-Pin DIP (50/Tube) |
| LBA110PL | 8-Pin SOIC (Flatpack) (50/Tube) |
| LBA110PLTR | 8-Pin SOIC (Flatpack) (1000/Reel) |
| LBA110LS | 8-Pin Surface Mount (50/Tube) |
| LBA110LSTR | 8-Pin Surface Mount (1,000/Reel) |

Pin Configuration

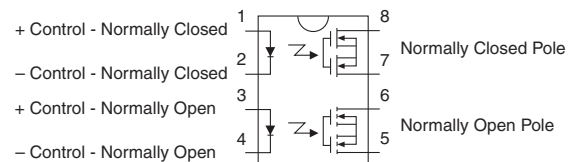

Switching Characteristics of Normally Open (Form A) Devices

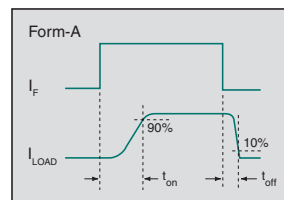

Switching Characteristics of Normally Closed (Form B) Devices

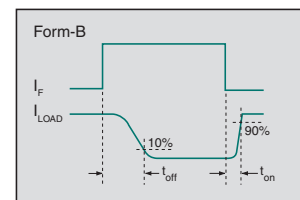

Absolute Maximum Ratings @ 25°C

| Parameter | Ratings | Units |
|--------------------------------------|-------------|------------------|
| Blocking Voltage | 350 | V _P |
| Reverse Input Voltage | 5 | V |
| Input Control Current | 50 | mA |
| Peak (10ms) | 1 | A |
| Input Power Dissipation ¹ | 150 | mW |
| Total Power Dissipation ² | 800 | mW |
| Isolation Voltage, Input to Output | 3750 | V _{rms} |
| Operational Temperature, Ambient | -40 to +85 | °C |
| Storage Temperature | -40 to +125 | °C |

¹ Derate linearly 1.33 mW / °C

² Derate output power linearly 6.67 mW / °C

Absolute Maximum Ratings are stress ratings. Stresses in excess of these ratings can cause permanent damage to the device. Functional operation of the device at conditions beyond those indicated in the operational sections of this data sheet is not implied.

Typical values are characteristic of the device at +25°C, and are the result of engineering evaluations. They are provided for information purposes only, and are not part of the manufacturing testing requirements.

Electrical Characteristics @ 25°C

| Parameter | Conditions | Symbol | Min | Typ | Max | Units |
|-------------------------------------|--|-------------------|------|------|------|--------------------------------------|
| Output Characteristics | | | | | | |
| Blocking Voltage | I _L =1μA | V _{DRM} | 350 | - | - | V _P |
| Load Current, AC/DC | | | | | | |
| Continuous ¹ | - | I _L | - | - | ±120 | mA _{rms} / mA _{DC} |
| Peak (1-Form-B) | t=10ms | I _{LPK} | - | - | ±350 | mA _P |
| Load Current Limiting (1-Form-A) | - | I _{CL} | ±130 | ±170 | ±210 | mA |
| On-Resistance ² | I _L =120mA | R _{ON} | - | 23 | 35 | Ω |
| Off-State Leakage Current | V _L =350V _P | I _{LEAK} | - | - | 1 | μA |
| Switching Speeds | | | | | | |
| Turn-On | I _F =5mA, V _L =10V | t _{on} | - | - | 3 | ms |
| Turn-Off | | t _{off} | - | - | 3 | |
| Output Capacitance | V _L =50V, f=1MHz | C _{OUT} | - | 25 | - | pF |
| Input Characteristics | | | | | | |
| Input Control Current to Activate | I _L =120mA | I _F | - | - | 5 | mA |
| Input Control Current to Deactivate | - | - | 0.4 | 0.7 | - | mA |
| Input Voltage Drop | I _F =5mA | V _F | 0.9 | 1.36 | 1.5 | V |
| Reverse Input Current | V _R =5V | I _R | - | - | 10 | μA |
| Common Characteristics | | | | | | |
| Input to Output Capacitance | V _{IO} =0V, f=1MHz | C _{IO} | - | 3 | - | pF |

¹ If both poles operate, then the load current must be derated so as not to exceed the package power dissipation value.

² Measurement taken within one (1) second of on-time.

Form-A/Form-B PERFORMANCE DATA*

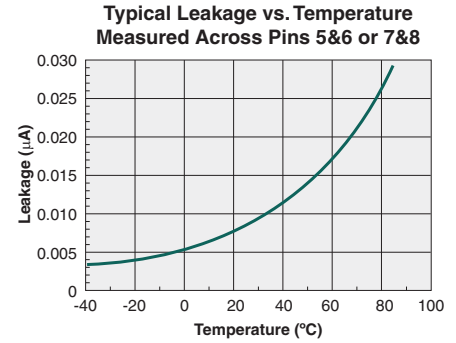
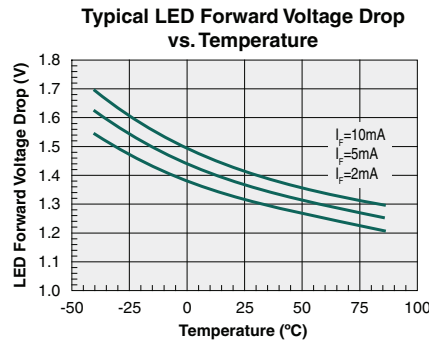
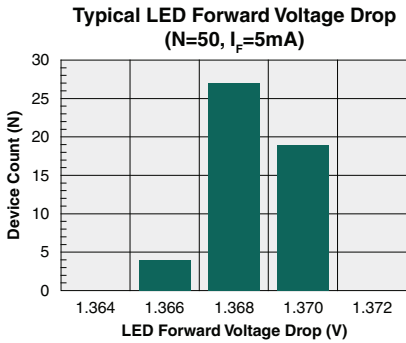

Form-A RELAY PERFORMANCE DATA*

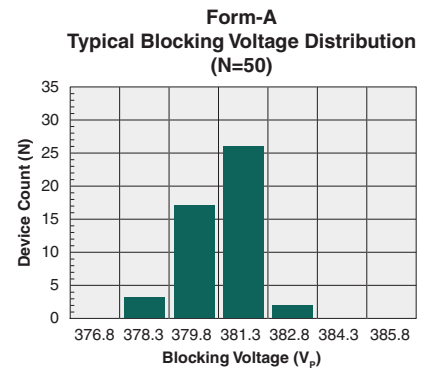
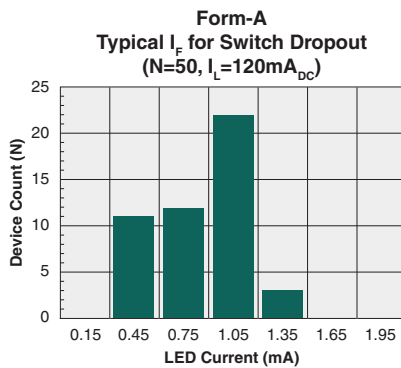
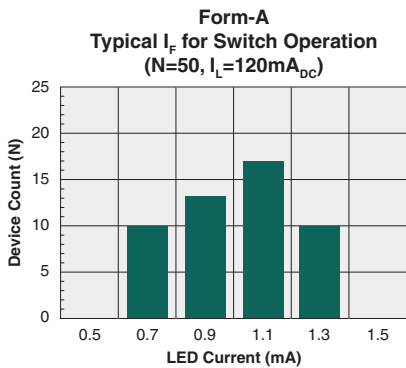
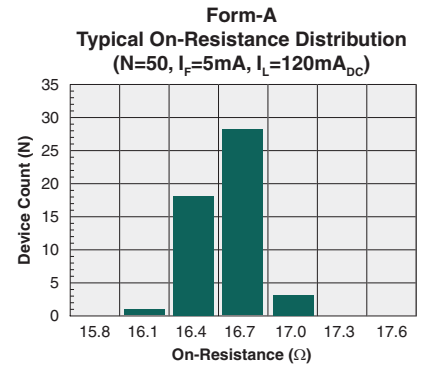
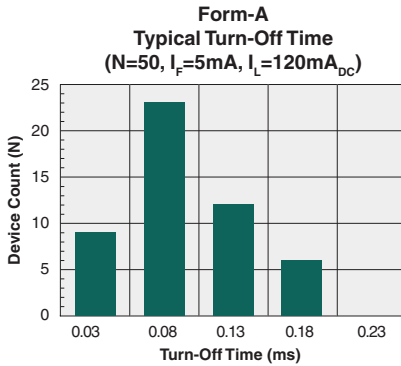
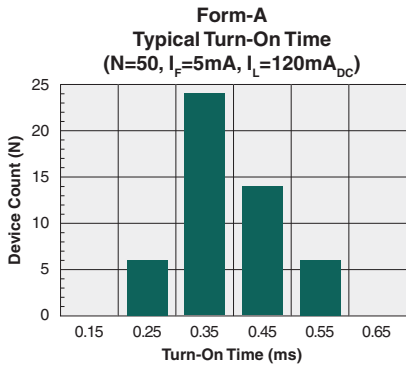

*Unless otherwise noted, data presented in these graphs is typical of device operation at 25°C.

Form-A PERFORMANCE DATA*

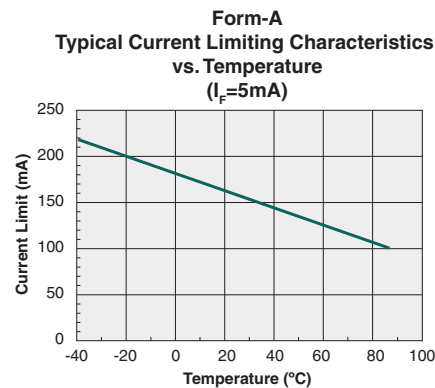
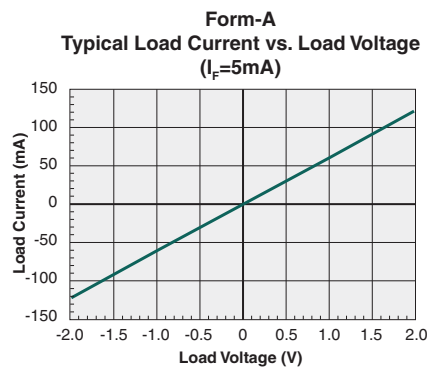
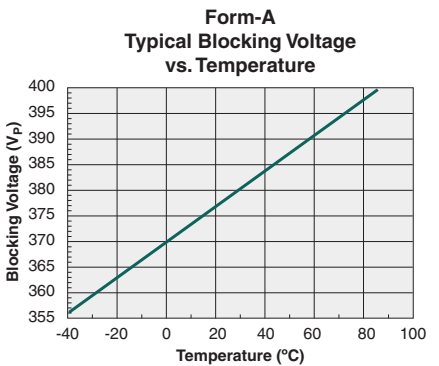
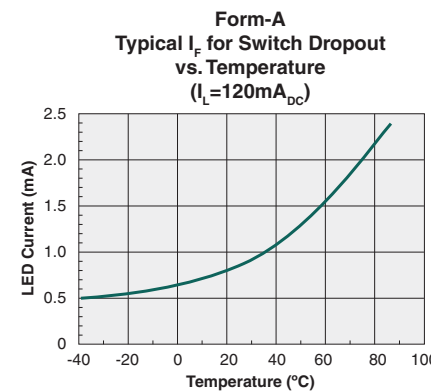
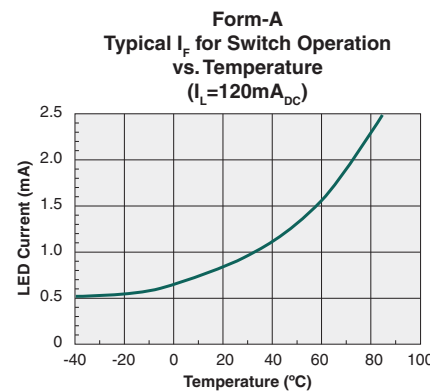
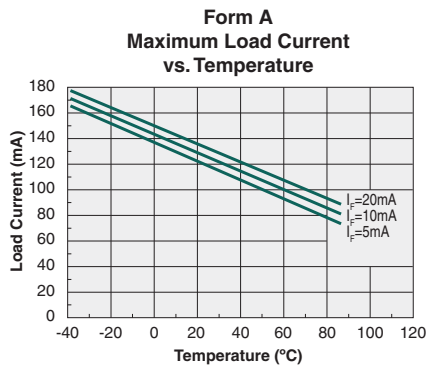
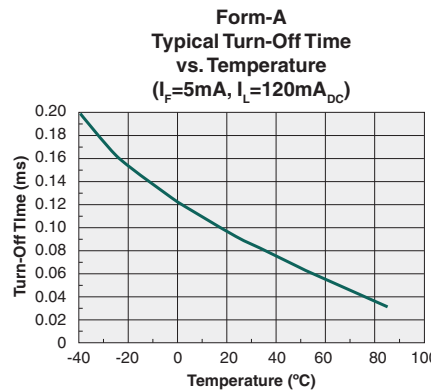
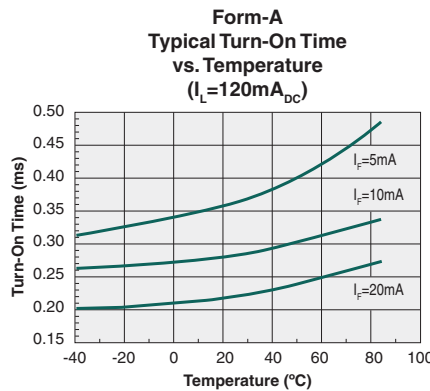
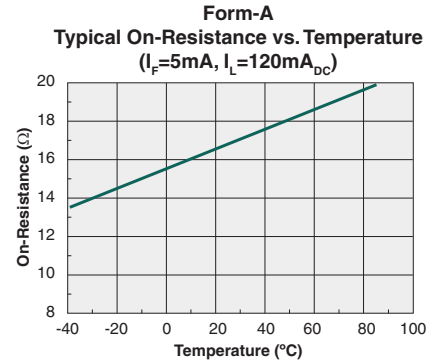
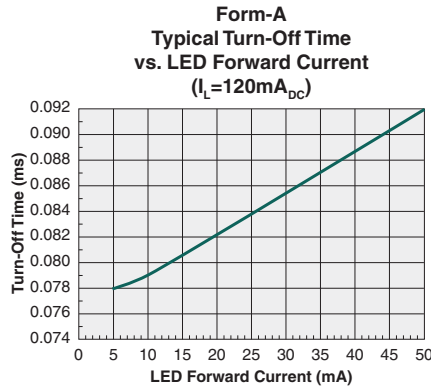
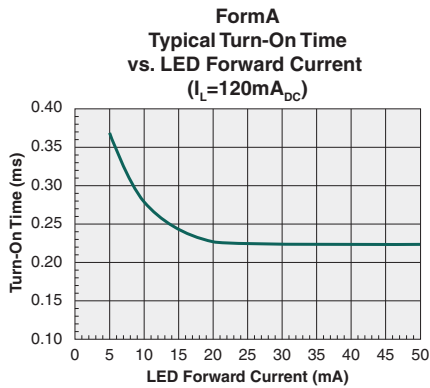

*Unless otherwise noted, data presented in these graphs is typical of device operation at 25°C.

Form-B PERFORMANCE DATA*

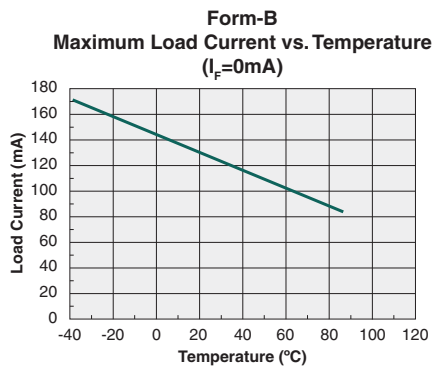
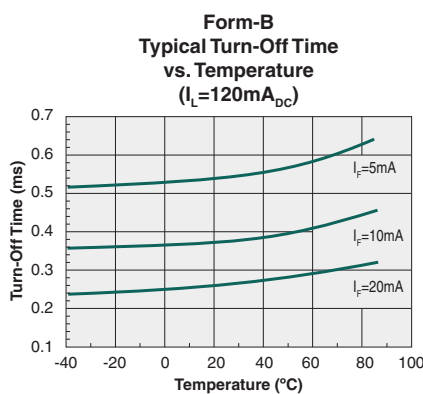
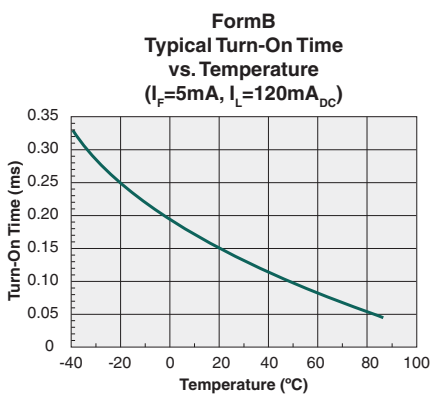
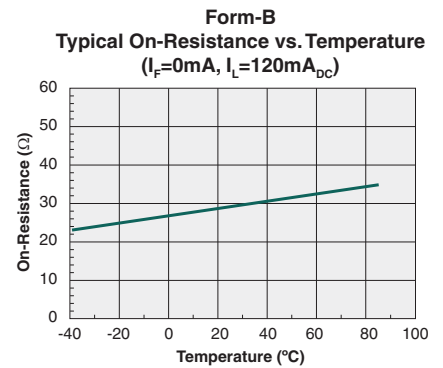
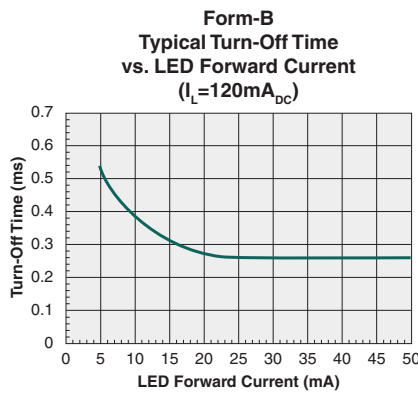
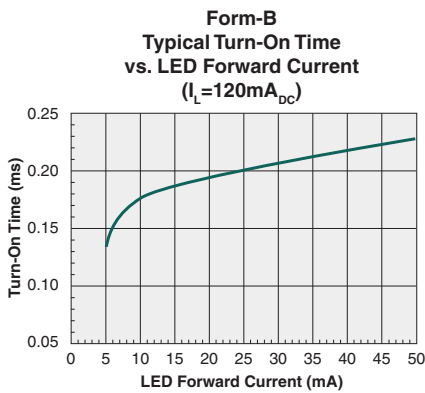
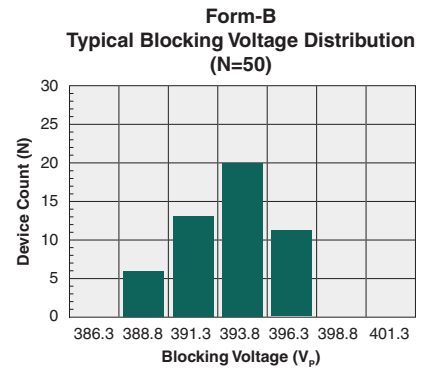
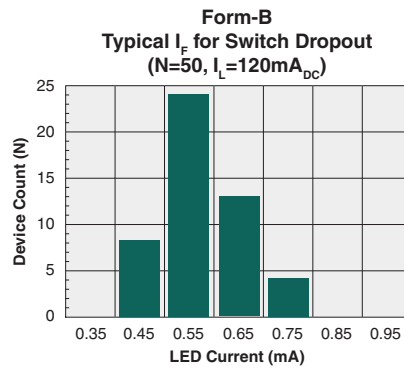
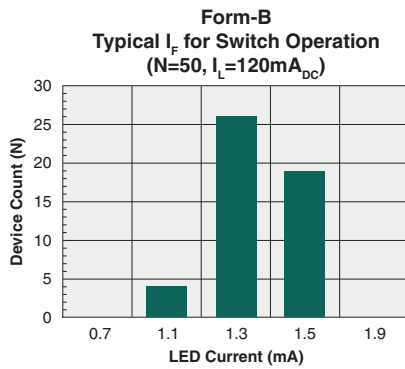
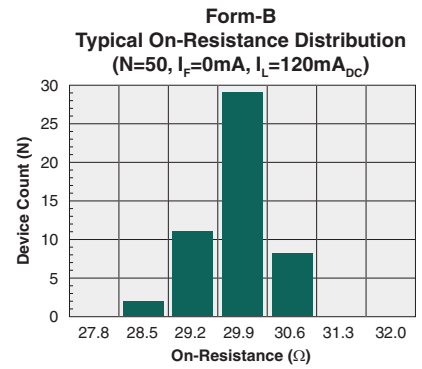
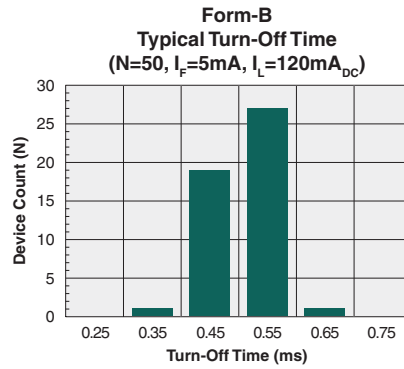
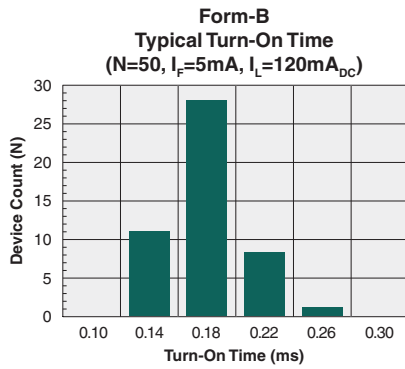

*Unless otherwise noted, data presented in these graphs is typical of device operation at 25°C.

Form-B PERFORMANCE DATA*

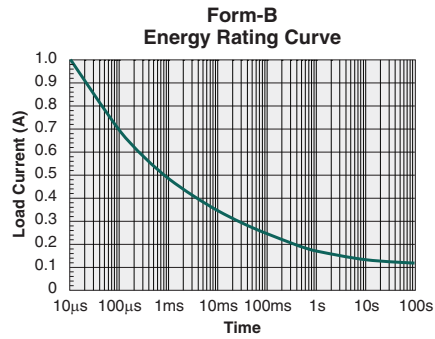
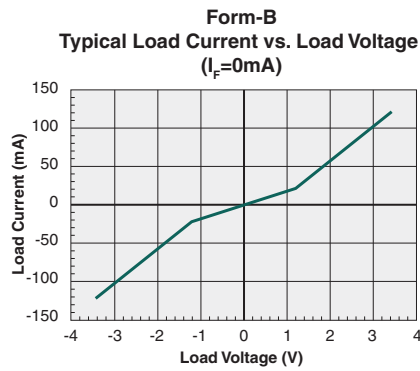
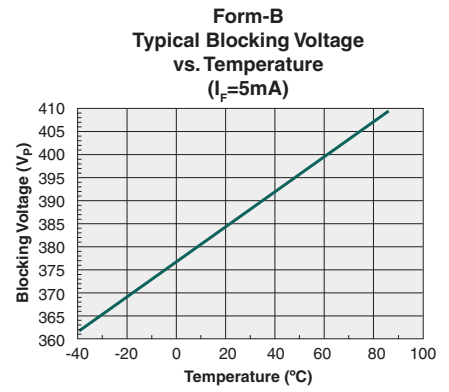
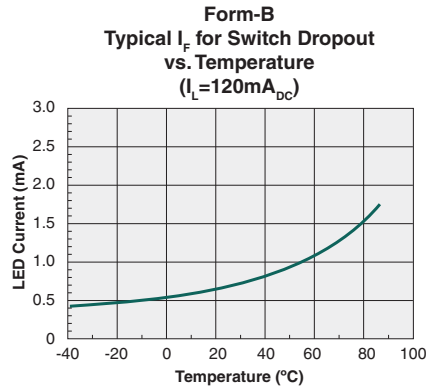
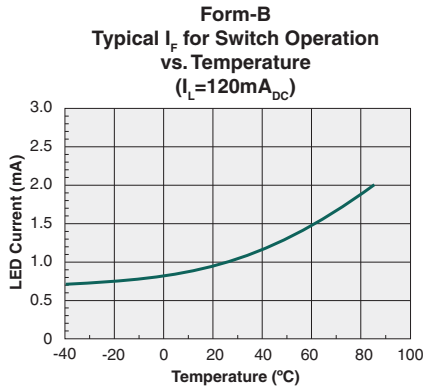

*Unless otherwise noted, data presented in these graphs is typical of device operation at 25°C.

Manufacturing Information

Moisture Sensitivity



All plastic encapsulated semiconductor packages are susceptible to moisture ingress. IXYS Integrated Circuits classifies its plastic encapsulated devices for moisture sensitivity according to the latest version of the joint industry standard, **IPC/JEDEC J-STD-020**, in force at the time of product evaluation. We test all of our products to the maximum conditions set forth in the standard, and guarantee proper operation of our devices when handled according to the limitations and information in that standard as well as to any limitations set forth in the information or standards referenced below.

Failure to adhere to the warnings or limitations as established by the listed specifications could result in reduced product performance, reduction of operable life, and/or reduction of overall reliability.

This product carries a **Moisture Sensitivity Level (MSL)** classification as shown below, and should be handled according to the requirements of the latest version of the joint industry standard **IPC/JEDEC J-STD-033**.

| Device | Moisture Sensitivity Level (MSL) Classification |
|----------|---|
| LBA110LS | MSL 1 |
| LBA110PL | MSL 3 |

ESD Sensitivity



This product is ESD Sensitive, and should be handled according to the industry standard **JESD-625**.

Soldering Profile

Provided in the table below is the **IPC/JEDEC J-STD-020** Classification Temperature (T_C) and the maximum total dwell time (t_p) in all reflow processes that the body temperature of these surface mount devices may be ($T_C - 5$)°C or greater. The device's body temperature must not exceed the Classification Temperature at any time during reflow soldering processes.

| Device | Classification Temperature (T_C) | Dwell Time (t_p) | Max Reflow Cycles |
|----------|--------------------------------------|----------------------|-------------------|
| LBA110LS | 250°C | 30 seconds | 3 |
| LBA110PL | 245°C | 30 seconds | 3 |

For through-hole devices, the maximum pin temperature and maximum dwell time through all solder waves is provided in the table below. Dwell time is the interval beginning when the pins are initially immersed into the solder wave until they exit the solder wave. For multiple waves, the dwell time is from entering the first wave until exiting the last wave. During this time, pin temperatures must not exceed the maximum temperature given in the table below. Body temperature of the device must not exceed the limit shown in the table below at any time during the soldering process.

| Device | Maximum Pin Temperature | Maximum Body Temperature | Maximum Dwell Time | Wave Cycles |
|---------|-------------------------|--------------------------|--------------------|-------------|
| LBA110L | 260°C | 250°C | 10 seconds* | 1 |

*Total cumulative duration of all waves.

Board Wash

IXYS Integrated Circuits recommends the use of no-clean flux formulations. Board washing to reduce or remove flux residue following the solder reflow process is acceptable provided proper precautions are taken to prevent damage to the device. These precautions include but are not limited to: using a low pressure wash and providing a follow up bake cycle sufficient to remove any moisture trapped within the device due to the washing process. Due to the variability of the wash parameters used to clean the board, determination of the bake temperature and duration necessary to remove the moisture trapped within the package is the responsibility of the user (assembler). Cleaning or drying methods that employ ultrasonic energy may damage the device and should not be used. Additionally, the device must not be exposed to halide flux or solvents.



MECHANICAL DIMENSIONS

LBA110L

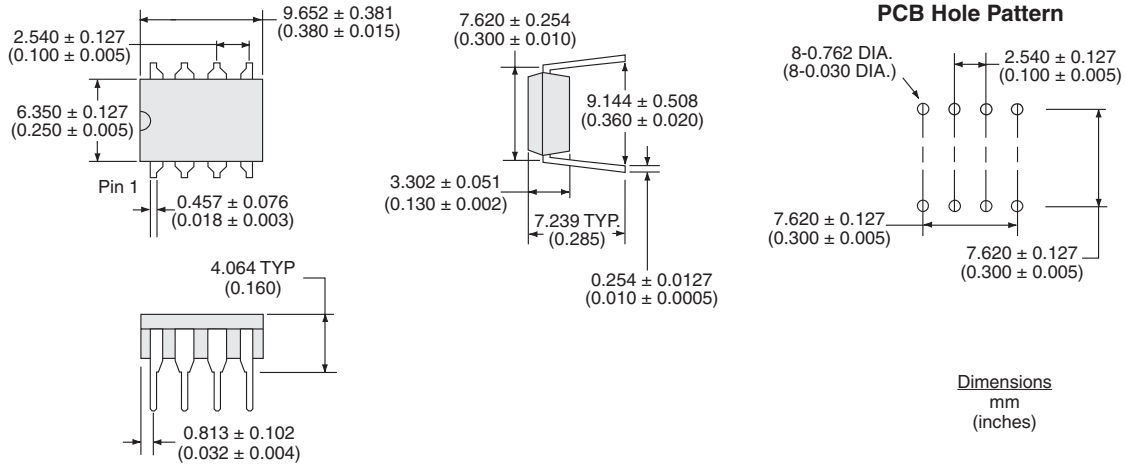

LBA110LS

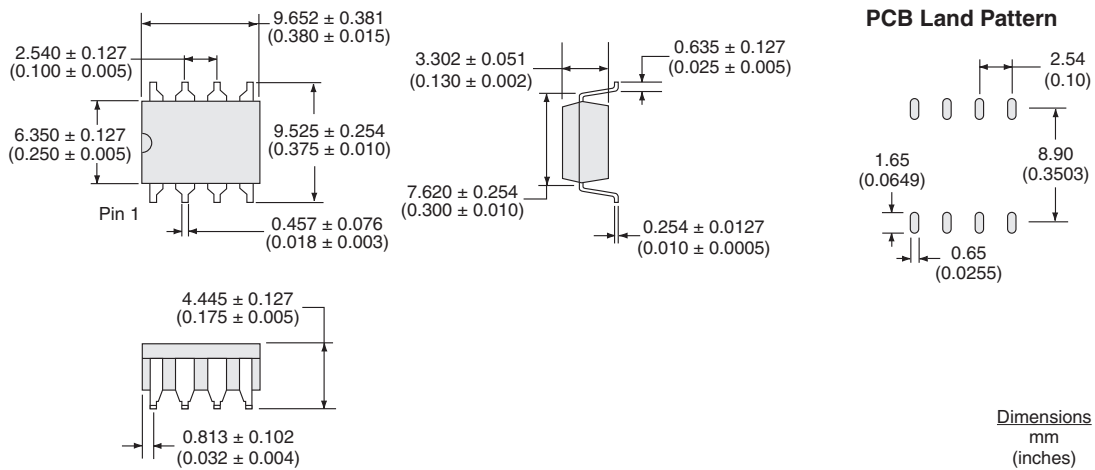

LBA110PL

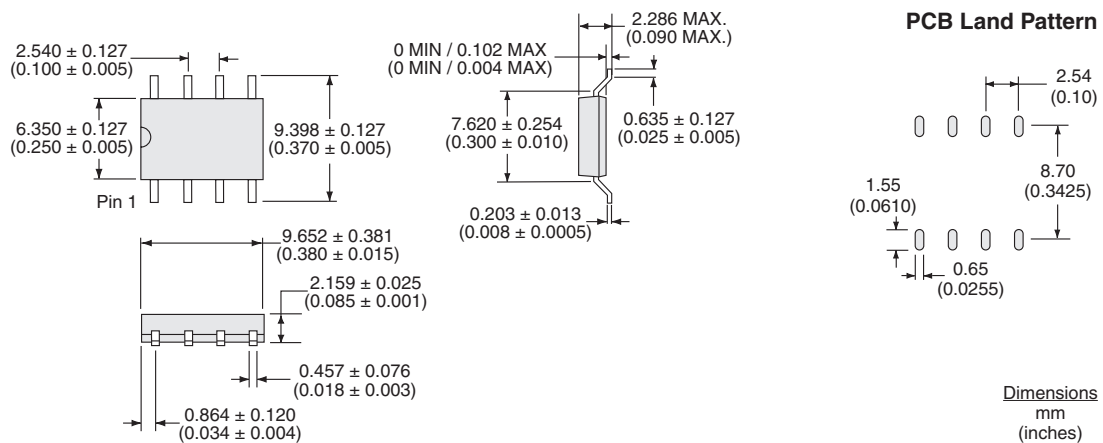

MECHANICAL DIMENSIONS

LBA110LSTR Tape & Reel

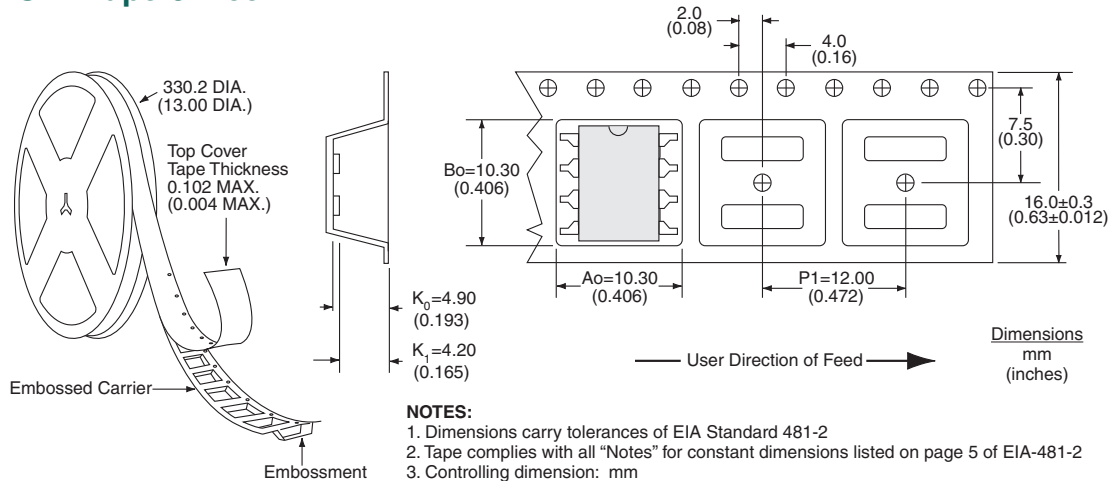

LBA110PLTR Tape & Reel

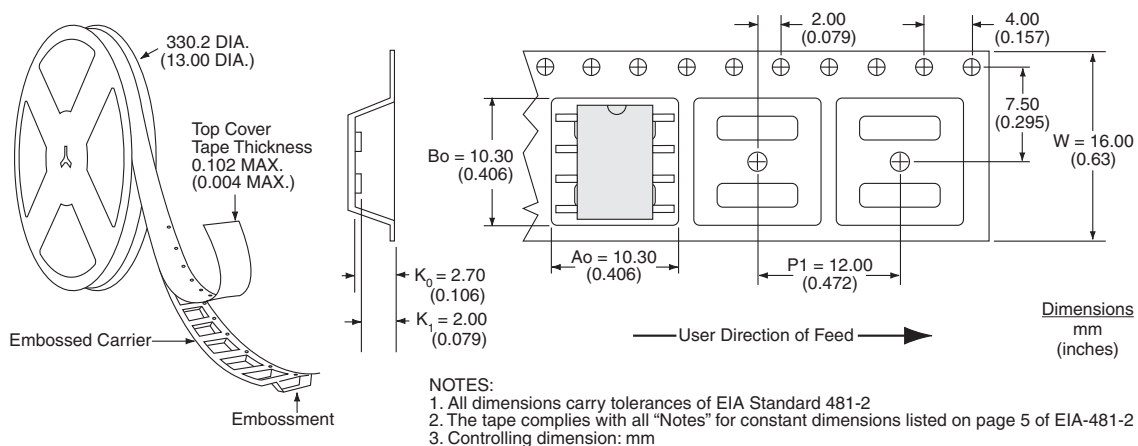

For additional information please visit our website at: <https://www.ixysic.com>