

PART NUMBER	UPC CODE
LDM3CU13	07945831143

REVISION		DESCRIPTION
REV	DATE	
A	5/5/23	526436GCP - RELEASE MRY

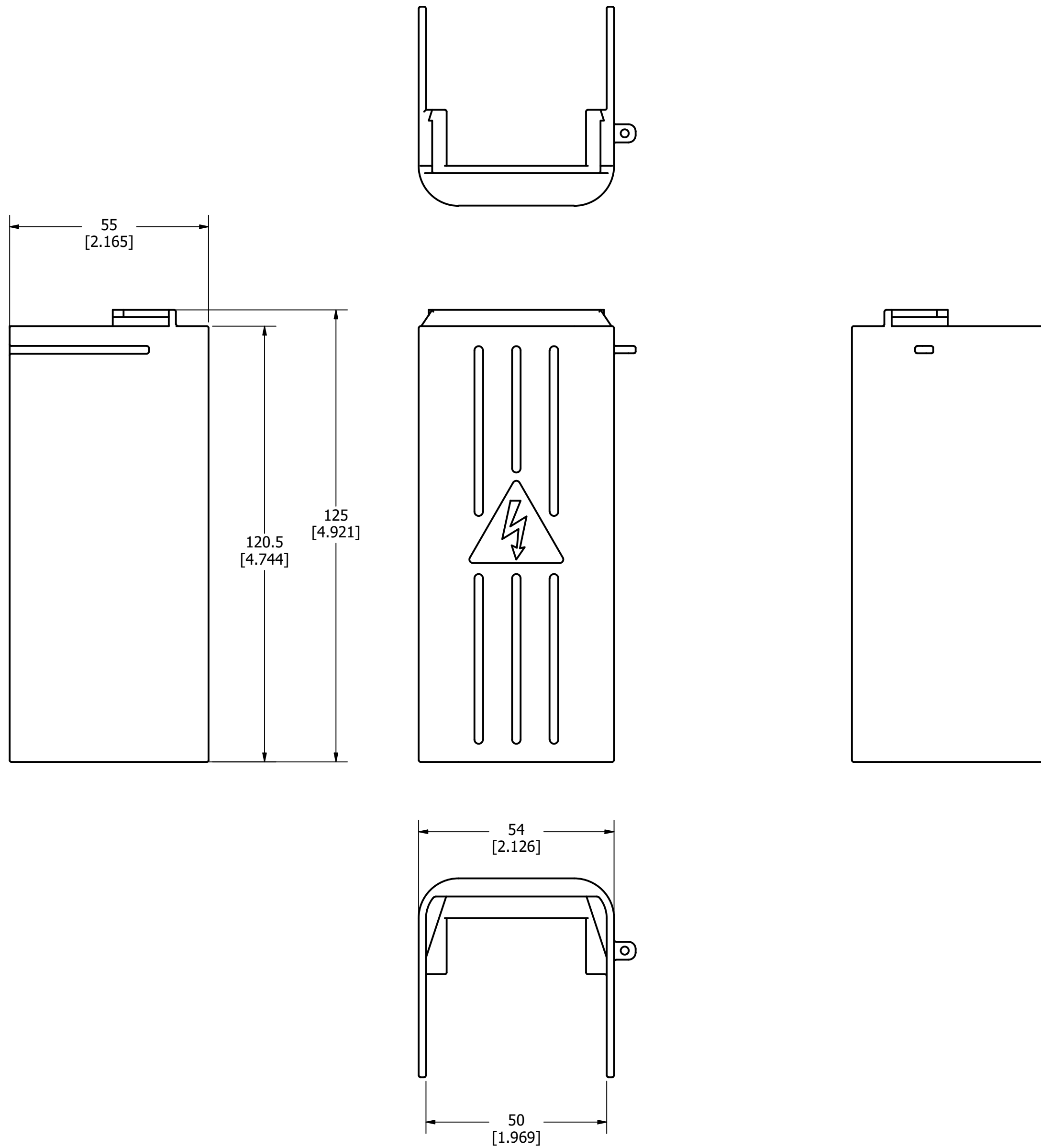

1	NO	COMPONENT NO	DESCRIPTION	QTY/M	U/M
BILL OF MATERIAL					
<S>	CRITICAL CHARACTERISTIC FOR PART SAFETY/COMPLIANCE				
●	DENOTES CRITICAL CHARACTERISTICS.				
CPK	DENOTES CPK DIMENSIONS, -MINIMUM CPK VALUE				
(ST)	DENOTES A CHARACTERISTIC THAT PROVIDES AN INDICATION OF PROCESS PERFORMANCE. PROCEDURE FOR MEASUREMENT AND TRACKING TO BE DEFINED IN LITTELFUSE INSPECTION INSTRUCTIONS.				
CP	DENOTES CP DIMENSIONS, -MINIMUM CP VALUE MUST BE WITHIN THE DIMENSIONAL LIMITATIONS SHOWN ON DRAWING AND INITIALLY LOCATED TO ALLOW FOR MAXIMUM TOOL LIFE.				
MATL SPEC			FINISH		
DRW	DATE	SCALE	FINISH GOOD WT		
myork	1/10/2023	NTS	GRAMS/PIECE		
UNLESS OTHERWISE SPECIFIED, DIMENSIONS ARE IN MILLIMETERS, DIMENSIONS IN BRACKETS [] ARE INCHES DIMENSIONING AND DO NOT INCLUDE PLATING. TOLERANCING TO BE INTERPRETED IN ACCORDANCE WITH ANSI Y14.5M-1994					
3RD ANGLE PROJECTION					
TITLE TERMINAL SHROUD 4P 100-200A OUTLINE					
Littelfuse CHICAGO, ILLINOIS 60631			REVISION	DRWG NO.	SHEET 1 OF 1
			A	OL-LDM3CU13	