

MHP-TAM Series Breakers (Thermal Cutoff Devices)

MHP with Thermal Activation

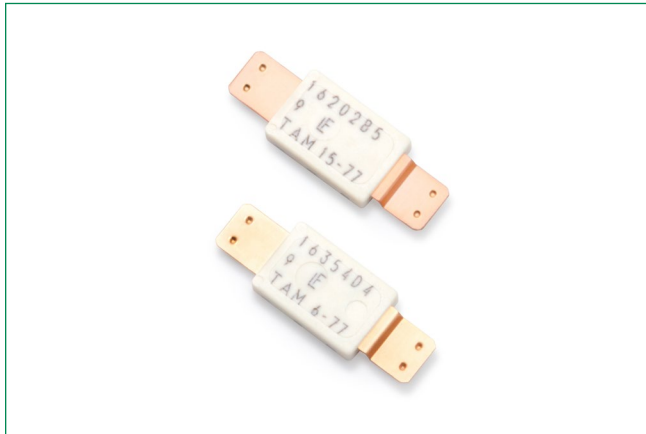

Description

The rapidly expanding market for ultra-thin portable electronic devices, such as media tablets and ultra-thin PCs, has created demand for very thin, low-profile, lightweight and high-capacity Lithium Polymer (LiP) and prismatic cells.

A new MHP (Metal Hybrid PPTC) device, the MHP-TAM device, offers a 9V_{DC} rating and a higher current rating than typical battery strap devices. This helps them meet the battery safety requirements of higher-capacity LiP and prismatic batteries found in the latest tablet and ultra-thin computing products. Hybrid MHP technology connects a bimetal protector in parallel with a PPTC (polymeric positive temperature coefficient) device. The resulting MHP-TAM (Thermal Activation) series helps provide resettable overtemperature and overcurrent protection, while utilizing the PPTC device to act as a heater and to help keep the bimetal latched until the fault is removed.

Web Resources



Download ECAD models, order samples, and find technical resources at www.littelfuse.com

Agency Approvals

Agency	Agency File Number
	E349829
	TAM15: US-29471-UL
	TAM6: US-29473-UL

Features

- 9V_{DC} rating
- Overtemperature and overcurrent protection for Lithium (Ion) Polymer and Prismatic cells
- Two levels of current carrying capacity:
Low current (nominal 6A hold current @25°C)
High current (nominal 15A hold current @25°C)
- Multiple activation temperature ratings (72°C, 77°C, 82°C, 85°C, 90°C)
- Compact size (L: 5.8mm x W: 3.85mm x H: 1.15mm Max.) allows for ultra-thin battery pack designs
- Evaluated to UL 60730-1 and UL 60730-2-9, CAN/CSA E60730-1, CAN/CSA E730-2-9 and IEC 60730-1 and IEC 60730-2-9

Circuit Diagram

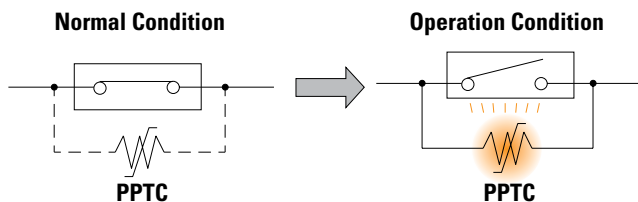

Benefits

- Capable of handling the higher voltages and battery discharge rates found in high-capacity LiP and prismatic cell applications
- Helps provide resettable overtemperature protection in high-capacity LiP and prismatic cell applications

Applications

Battery cell protection for high-capacity Lithium Polymer and prismatic cells used in:

- Notebook PCs
- Ultra-book
- Tablets
- Smart phones
- Battery-powered portable electronic devices

MHP-TAM Series Breakers (Thermal Cutoff Devices)

MHP with Thermal Activation

Electrical Characteristics for MHP-TAM15 Series

Part Description	Ordering Part Number	Rating [°C] Nominal	Operation Temperature [°C]		Reset Temperature [°C]		Reference Resistance [mohms] 25°C	
			Min	Max	Min	ΔT	Typ	Max
MHP-TAM15-9-72	RF4374-000	72	67	77	≥40	≥7	2.5	5
MHP-TAM15-9-72N	RF4849-000	72	67	77	≥40	≥7	2.5	5
MHP-TAM15-9-77	RF4375-000	77	72	82	≥40	≥10	2.5	5
MHP-TAM15-9-77N	RF4689-000	77	72	82	≥40	≥10	2.5	5
MHP-TAM15-9-82	RF4376-000	82	77	87	≥40	≥10	2.5	5
MHP-TAM15-9-82N	RF4866-000	82	77	87	≥40	≥10	2.5	5
MHP-TAM15-9-85	RF4377-000	85	80	90	≥40	≥10	2.5	5
MHP-TAM15-9-85N	RF4744-000	85	80	90	≥40	≥10	2.5	5
MHP-TAM15-9-90	RF4378-000	90	85	95	≥40	≥10	2.5	5
MHP-TAM15-9-90N	RF4867-000	90	85	95	≥40	≥10	2.5	5

Notes

1. Maximum breaking current $5V_{DC} / 80A$ (100 cycles)
2. Contact Rating $9V_{DC} / 25A$ (6000 cycles)

Electrical Characteristics for MHP-TAM6 Series

Part Description	Ordering Part Number	Rating [°C] Nominal	Operation Temperature [°C]		Reset Temperature [°C]		Reference Resistance [mohms] 25°C	
			Min	Max	Min	ΔT	Typ	Max
MHP-TAM6-9-72	RF4370-000	72	67	77	≥40	≥7	10	15
MHP-TAM6-9-77	RF4371-000	77	72	82	≥40	≥10	10	15
MHP-TAM6-9-82	RF4372-000	82	77	87	≥40	≥10	10	15
MHP-TAM6-9-85	RF4373-000	85	80	90	≥40	≥10	10	15

Notes

1. Maximum breaking current $5V_{DC} / 40A$ (100 cycles)
2. Contact Rating $9V_{DC} / 12A$ (6000 cycles)
3. ΔT is the minimum temperature differential between the actual operation temperature of the device and the reset temperature

Dimensions in Millimeters and Mechanical Characteristics

Unit	A		B	C		D		C	
	Min	Max	Max	Min	Max	Min	Max	Min	Max
mm:	10.9	11.4	1.15	3.75	3.85	2.6	2.8	2.6	2.8

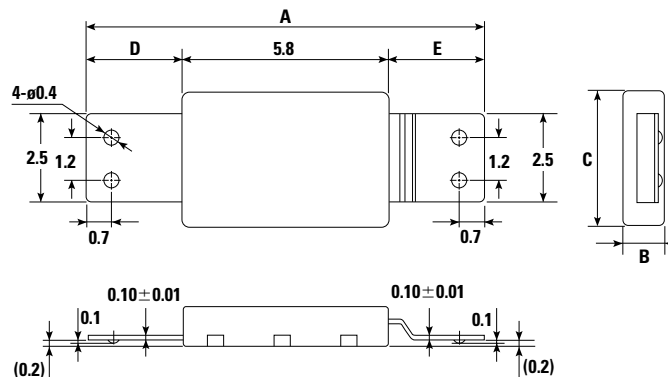

MHP-TAM Series Breakers (Thermal Cutoff Devices)

MHP with Thermal Activation

Hold Current vs. Temperature Curves (Typical)

Figure M1

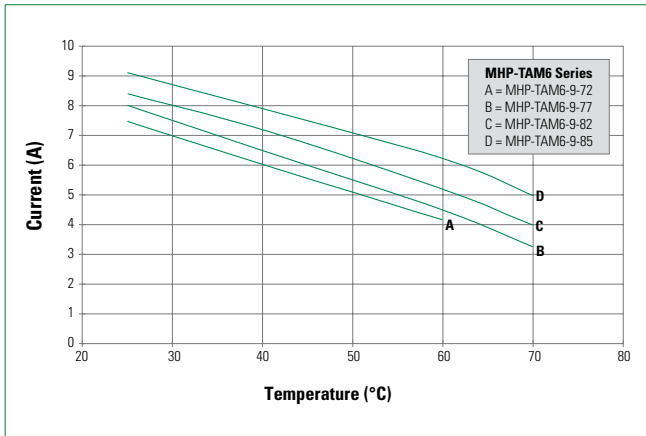
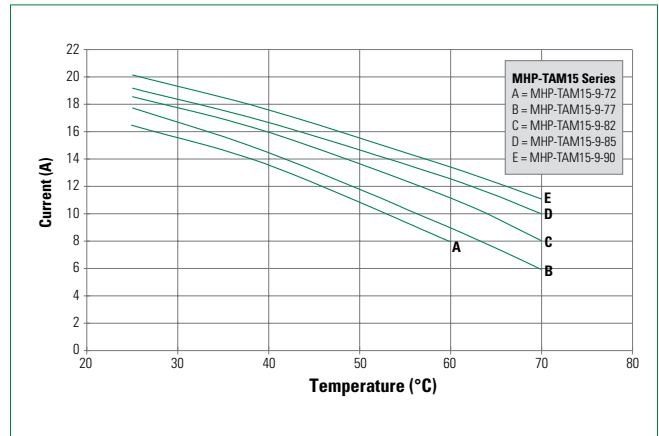

Figure M2



RoHS and Halogen-Free Compliance

- RoHS Compliant
- Halogen Free per IEC 61249-2-21

Packaging and Marking Information

	MHP-TAM 15 Series	MHP-TAM 6 Series
Bag Quantity	1,000	1,000
Standard Package	20,000	20,000
Part Marketing	Lot ID#, Control# & Co. Logo, Product #	Lot ID#, Control# & Co. Logo, Product #

Part Naming System

MHP TAM 15 9 72 N

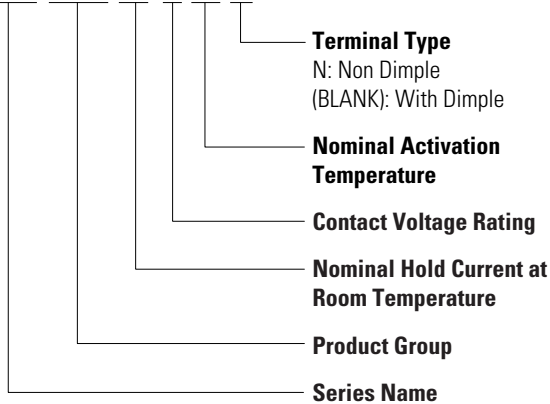

Ordering Information

Bag	1,000	pieces
Box	20,000	pieces

MHP-TAM Series Breakers (Thermal Cutoff Devices)

MHP with Thermal Activation

Precautions

- Operating Temperature Range -30~100°C
- In using the TCO devices, please check fully the precautions as stated below so that there will be no TCO performance deterioration and damage to TCO body or terminal. LF suggest extensive qualification testing be done on the product using prior to use in production, LF will not be responsible for the device performance failures that caused by misuse with violating below precautions statements.

Precautions for Electrical Characteristics

- Device electrical characteristics may change depending on installation conditions. Users should independently evaluate the suitability of and test each product in their own application.
- If any terminal or lead extensions are added to the device, especially in the case of high current discharging, the device performance may be negatively impacted due to variations in welding methods or materials. Please avoid designs that might cause heat to be generated around the joints of the lead extensions or on the extended terminals. SMT solder reflow, wave-soldering and manual soldering irons are not permitted.
- Mount the TCO device on your model where heat is the highest and transfer it effectively to the TCO.

Precautions for Rating

- The power supply voltage must be less than the rated voltage of the device. Operation above the voltage rating may result in device damage, smoking or flame and functional issue.
- Designs must be selected in such a manner that the device hold current is higher than the normal current value in the circuit and that the device trip current is lower than the abnormal current value. Selecting device hold current and trip current values that are too low for the application may interrupt the circuit under normal usage conditions.
- This product should not be used in an application where the maximum interrupt current can be exceeded in a short circuit condition.
- The devices are intended for protection against damage caused by occasional over current or over temperature fault conditions and should not be used when repeated fault conditions or prolonged trip events are anticipated.
- The devices may not perform as specified if mechanical pressure is added while the device is in the tripped state or exposed to temperature conditions over 100°C or in temperature conditions under -30°C.

Application Environment

The device is intended to be used for applications which are common for general electronic devices. Usage in any of the special environments or conditions as listed below may adversely impact the device performance and therefore users should carefully consider conditions of use of the end product and the potential impact on reliability or performance when incorporating this device into any design to carefully examine the actual performance and reliability of the device.

Please do not use TCO device in following abnormal environment.

- Environment where the devices are exposed to water, oil, chemical solutions, and/or organic solvents.
- Installation in an area close to a heat source or adjacent to or near flammable objects such as plastic wires.
- Environment in which the device is constrained by pressure, sealing or resin coating.
- Environment where water condenses on the device.
- Environment with salt air or with corrosive gas such as CL₂, H₂S, NH₃, SO₂, and NO_x.
- Environment with grit and dust and/or under direct sunlight.
- Environment outside of recommended operating temperature.

MHP-TAM Series Breakers (Thermal Cutoff Devices)

MHP with Thermal Activation

Precautions for Handling when Installation

- The device is composed of plastic parts, please do not clamp or dent the housing with a tool as this might cause a resistance increase and product damage.
- When welding product terminals or mounting the breaker on a battery (cell) please be careful not to apply excessive bending, twisting or force on the product and terminals. The excessive stress might cause a resistance increase or product damage.
- When welding product terminals on battery or in any installation or testing process, please be careful not to apply any overheating on TCO, any appearance damage on TCO body caused by overheating during installation is not acceptable. The excessive overheating might cause a structural damage and lead to product performance issue.
- TCO is not washable, please do not wash.
- When mount or after mounting TCO, do not apply ultrasonic vibration. The vibration and heat might cause TCO resistance increase or body damage. If you apply ultrasonic vibration after mounting TCO, please test and evaluate for specific application and confirm that there will be no problem and judge whether it can be used or not.
- After TCO is mounted, fix it so that TCO body and terminals will not move and if not fixed, it might be a cause of TCO resistance increase or contact open due to stress during handling or vibration or shock during transportation.

Please refer to following cautions.

1. Do not apply more than 10N bend force to product. (Fig.-1)
2. Do not apply more than 1.5cN*m twist torque to the product. (Fig.-2)
3. Do not apply more than 20N deflection force to product. (Fig.-3)
4. Do not apply more than 2N force to the terminals. (Fig.-4)
5. Do not apply more than 0.6cN*m twisting torque to the terminals. (Fig.-5)
6. Do not bend the terminals more than 45° at the end. (Fig.-6)
7. Should not twist terminals more than 10° with breaker body fixed.

Figure 1

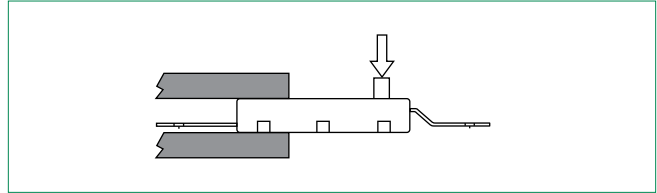

Figure 2

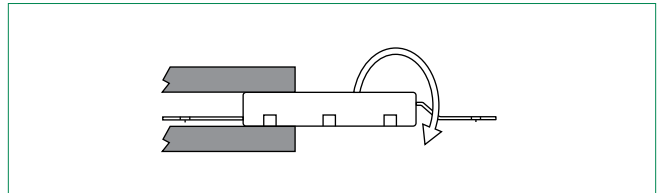

Figure 3

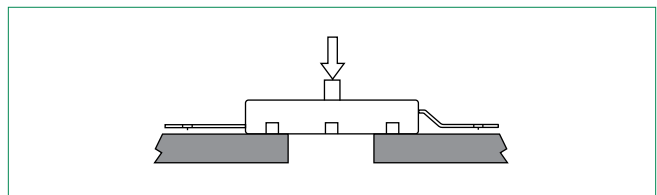

Figure 4

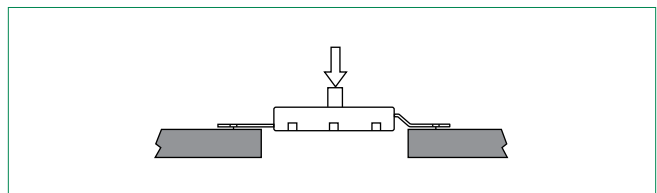

Figure 5

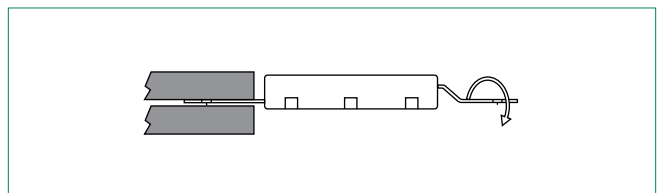
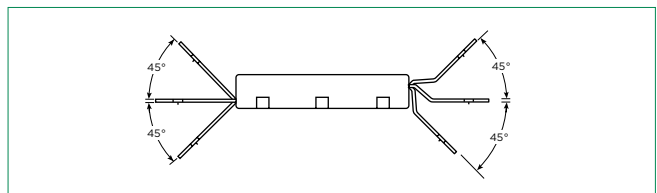

Figure 6



MHP-TAM Series Breakers (Thermal Cutoff Devices)

MHP with Thermal Activation

Precautions for Handling when Installation

- Product terminals can be welded by spot welding using direct welding (refer to Fig-7) and series welding methods (Refer to Fig-8). In either case, please use a suitable Jig so that the device will not be subjected to the stress conditions listed above. Also user need evaluate welding process very carefully prior to production with selecting suitable welding terminal, defining suitable welding position and setting sufficient welding energy, excessive heating and stress generated by welding process might cause TCO body damage, inner structure damage and performance issue.
- Product terminals can be laser welded (refer to Fig-9), In this case, please use a suitable Jig so that the device will not be subjected to the stress conditions listed above. Also user need evaluate laser welding process very carefully prior to production with selecting suitable welding terminal, defining suitable welding position and setting sufficient laser welding energy, excessive heating and stress generated by laser welding process might cause TCO body damage, inner structure damage and performance issue.
- Pull strength and detach strength of the terminal welds are per user requirements. However, if the welding is controlled by resistance, the measurement should be made as close as possible to the weld point by a "4-point clip method" using milliohm meter to ensure accuracy, also need put the TCO device terminal on supporting plate with avoiding any stress applied on terminal by testing probe pressing. (refer to Fig-10)
- Please avoid putting the stress on the device, as listed above, when a jig, fitting or additional welding process is used. Please re-confirm the resistance value whenever a new process is added.

Due to changes by safety standard, there might be changes in design /spec in this TCO datasheet and usage guidelines without prior notification. Therefore, before design in TCO device in your application or any process change in your application, please ask for us to submit our specific TCO datasheet and usage guidelines to make sure up to date version.

Figure 7

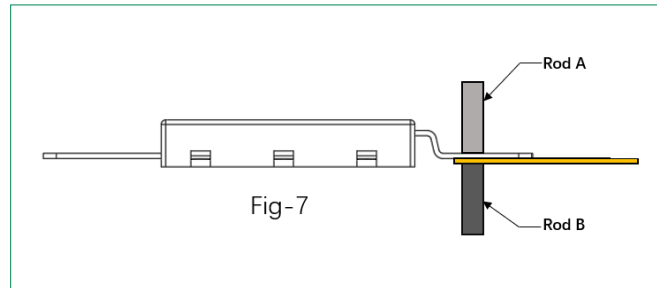

Figure 8

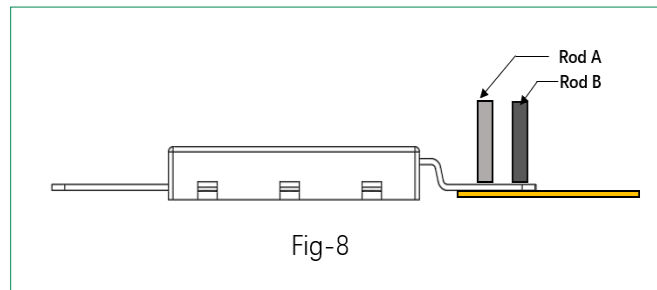

Figure 9

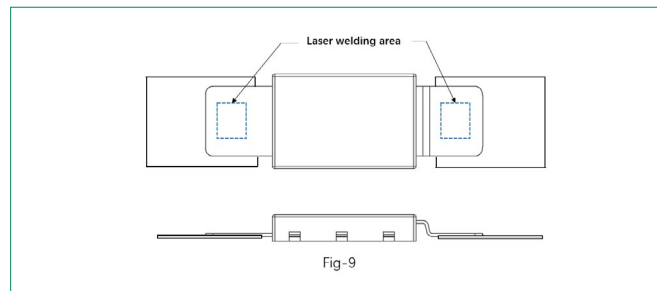

Figure 10

