

Via Ghiacciaia, 1 - 37045 Legnago (Verona) ITALY  
 Tel. +39 0442 606200 - Fax +39 0442 28855,  
 www.members.it - members@members.it

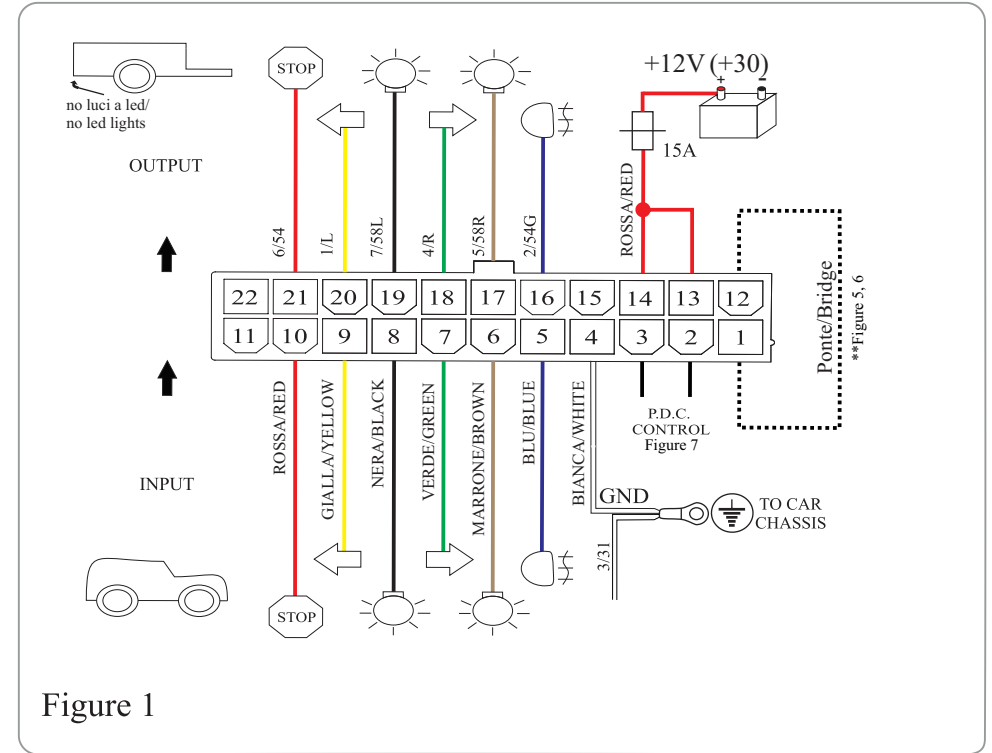
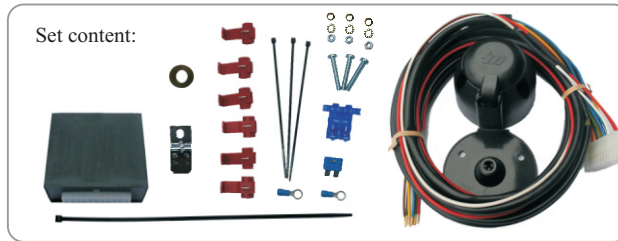
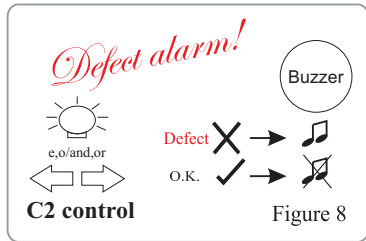
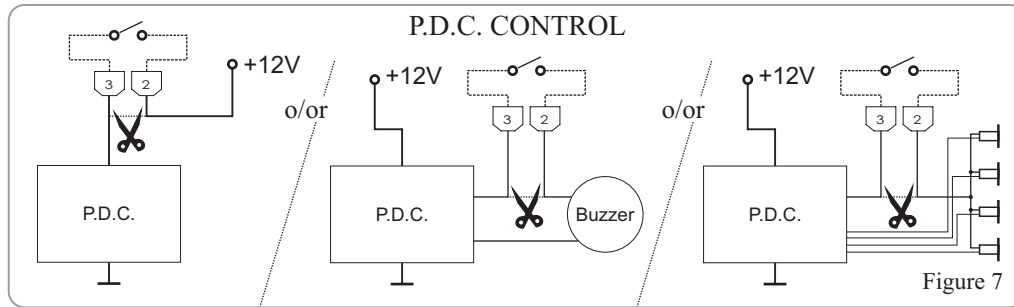

## Avvertenze - Warning - Warnungen - Avertisiements - Advertencias - Opozorilo

I	Il fabbricante garantisce che il modulo installato è esente da difetti di qualità. Il produttore assicura una garanzia di 2 anni dalla data di vendita dello stesso, come stabilito dalla legge 1999/44/CE. Un eventuale montaggio scorretto o se tale operazione viene effettuata da una persona non competente annullerà ogni diritto di rimborso o determinerà la fine di ogni responsabilità civile in riferimento al prodotto stesso.
GB	The manufacturer guarantees that this module is free of any quality defect. The manufacturer offers a two year guarantee from the date of the sale of the module, in accordance to the 1999/44/CE guideline. The inappropriate assembly or if this is done by a not qualified operator will result in the cancellation of any right to compensation or the end of any civil liability in reference to this product.
D	Der Hersteller gewährleistet, dass das Module frei von Mängel und Material und Funktionsfehlern ist. Der Hersteller bietet eine 2 Jahre Garantie ab dem Tag des Kaufs eines Modules, gemäß die Richtlinie 1999/44/CE. Der unrichtiger Montage oder wann der montage würde beim keiner Spezialist gemacht würde das Recht eine Schadenersatz abschreiben und der Ende der Haftpflicht.
F	Le fabricant garantis que ce module n'a aucun défaut de qualité. Le fabricant offre une garantie de 2 ans des la vente du module selon la Normative 1999/44/CE. Le montage inadéquat et effectué par une personne non qualifiée provoquera la perte de tout droit a une indemnisation ou la fin de toute responsabilité civil a vis du produit.
E	El fabricante garantiza que este módulo está libre de cualquier defecto de calidad. El fabricante ofrece una garantía de dos años desde la fecha de venta del módulo, conforme a lo dispuesto en la Directiva 1999/44/CE. El montaje inapropiado y efectuado por personal no cualificado originará la pérdida de todo derecho a indemnización o la expiración de toda responsabilidad civil con respecto al producto.
SLO	Proizvajalec zagotavlja, da izdelek deluje brez napak. Proizvajalec zagotavlja garancijsko dobo dveh let od prodaje, tako kot to urejajo normativi 1999/44/CE. Ob morebitni nepravilni in/ali nestrokovni vgradnji izdelka, je proizvajalec oproščen izpolnjevanja vseh garancijskih in pravnih odgovornosti.

cod.80170292 rev.B - edizione Gennaio 2016

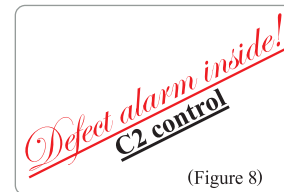
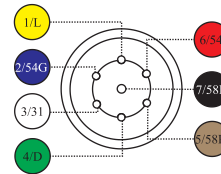

## CELU 7P1

KIT ELETTRICO UNIVERSALE  
 7 POLI CON CENTRALINA  
 PER GANCIO TRAINO

UNIVERSAL 7 PIN  
 ELECTRIC WIRING KIT  
 FOR TOWBAR

Made in EU

U=12V		P max.
←	1/L	2X21W
⚡	2/54	2X21W
⚡	3/31	
→	4/R	2X21W
💡	5/58	6X5=30W
STOP	6/54	2X21W
💡	7/58	6X5=30W
⚡	8/REV	2X21W
-20°C < Tamb. < +50°C		

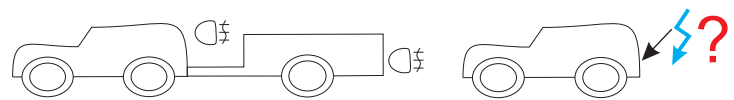

Figure 2  
Figure 3  
Figure 4

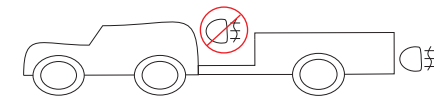

Figure 5  
Figure 6

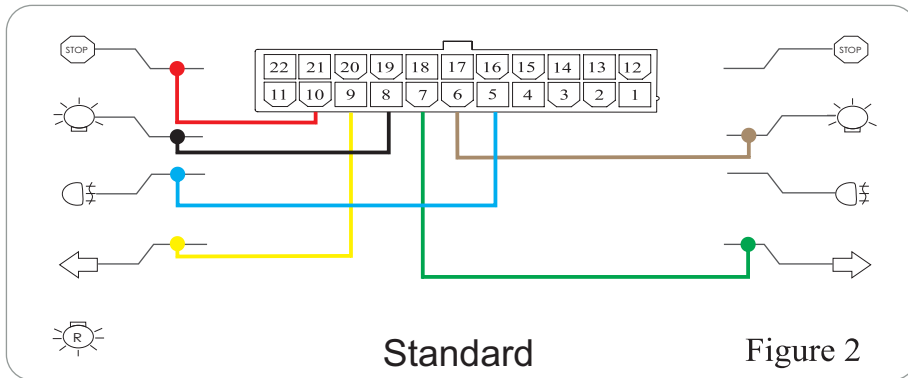

Figure 2

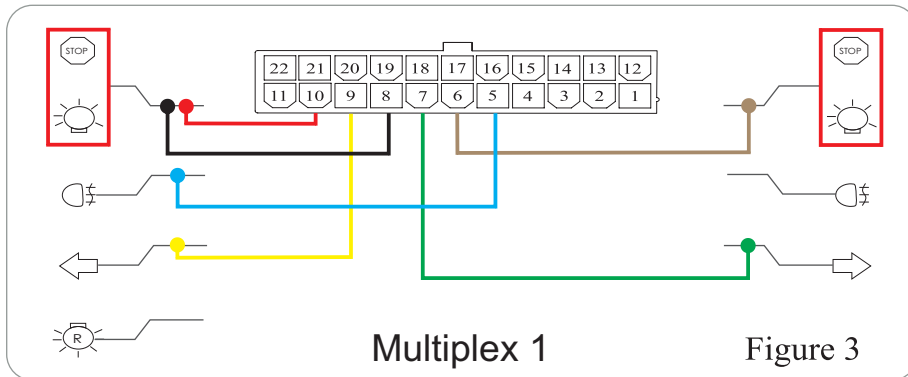

Figure 3

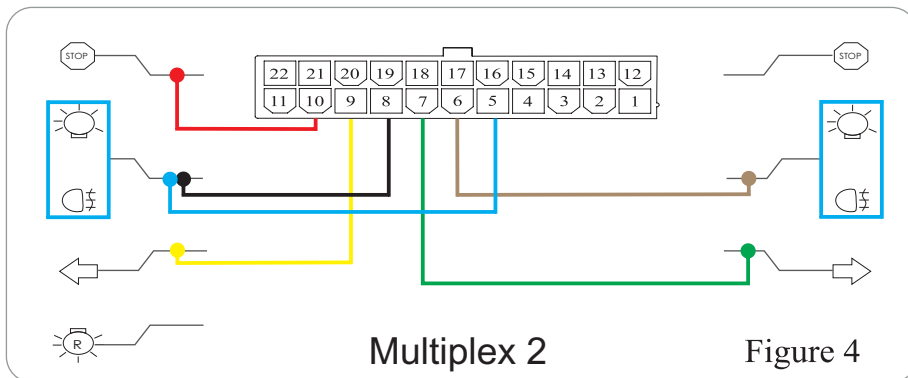

Figure 4











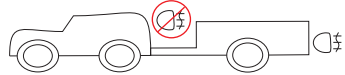

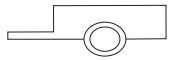











<div style="border: 1px solid black; padding: 2px;">                     12 ponte /bridge 1                 </div>				
Interruttore/switch				
1				
2	 accendere/turn on	 si accende/turns on	 si accende/turns on	
3	 spegnere/turn off	 si spegne/turns off	 acceso/turned on	 Beep 0,5 sek
4	 accendere/turn on	 si accende/turns on	 acceso/turned on	
5	 spegnere/turn off	 si spegne/turns off	 si spegne/turns off	

Figure 5

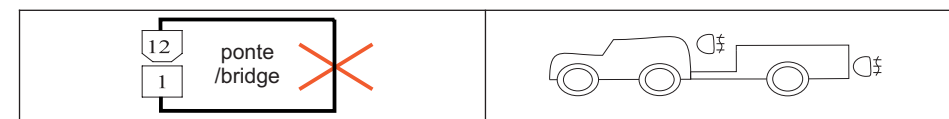

Figure 6