

# MIDI ISO Series

## Bolt-down Fuses – Rated 70 V-SF36

RoHS

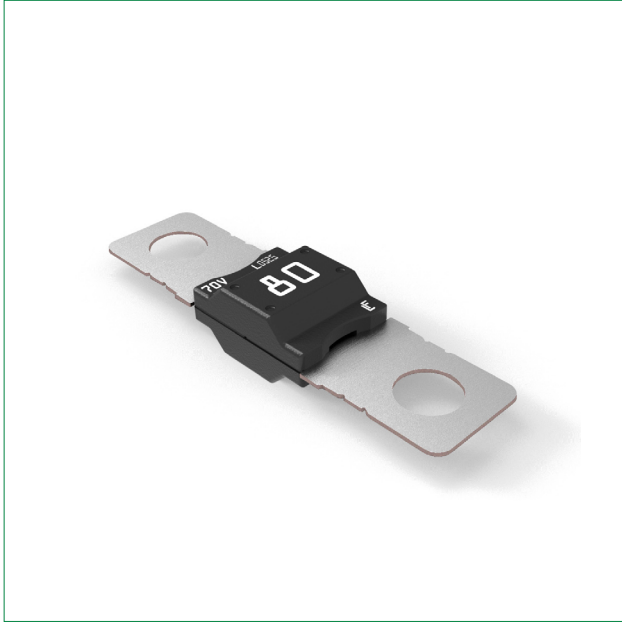

### Description

MIDI 70V ISO is the new Littelfuse bolt-down series designed to fulfill the ISO standard 20934, which makes this compact fuse the perfect solution for high current circuit protection in both 48V and 12V systems. With new housing features and a completely redesigned shape, MIDI 70V ISO M6 - SF36 can withstand a tightening torque up to 11.5 Nm. Covering the complete ISO fuse ratings from 30 A to 200 A, MIDI 70V ISO is available in different versions to satisfy every kind of mounting necessities (one-hole M6, two-holes M6 and no-hole version).

### Features & Benefits

- High-contrast ampere rating stamp on housing aids identification
- Available with two, one, or no mounting holes
- Suitable for 48V and 12V networks
- Comply with ISO 20934 – Type SF36
- High 1-time mounting torque

### Applications

- Cars / SUVs
- Buses
- Trucks
- Watercraft as approved by Littelfuse®
- Offroad vehicles

[See Disclaimer Notice](#)

### Specifications

<b>Voltage Rating:</b>	70 V DC
<b>Interrupting Rating:</b>	2500 A @ 70 V DC
<b>Recommended Environmental Temperature:</b>	-40 °C to +125 °C
<b>Terminals Material:</b>	Tin-plated copper alloy
<b>Housing Material:</b>	PA66-GF25 (UL 94 Flammability rating of V-0)
<b>Mounting Torque M6:</b>	9 Nm ± 1 Nm
<b>Typical Weight per Fuse:</b>	
<b>Comply With:</b>	ISO 20934 – Type SF36

### Additional Information



Resources



Samples











### Ordering Information

Part Number	Current Rating (A)	Bolt Size	Bolt Qty.	Package Size
4998xxx.MXISO-2M6	30–200	M6	2	700
4998xxx.MXISO-1M6	30–200	M6	1	700
4998xxx.MXISO-NH	30–200	-	-	700

# MIDI ISO Series

## Bolt-down Fuses – Rated 70 V-SF36

### Ratings

Part Number	Current Rating (A)	Housing Material Color	Test Cable Size (mm <sup>2</sup> )	Typ. Voltage Drop (mV)	Typ. Cold Resistance (mΩ)	Typ. I <sup>2</sup> t (A <sup>2</sup> s)
4998030.MXISO	30		2.5	120	2.00	5500
4998040.MXISO	40		4	120	1.53	8500
4998050.MXISO	50		6	120	1.25	6500
4998060.MXISO	60		6	110	0.99	14 500
4998070.MXISO	70		10	110	0.74	25 000
4998080.MXISO	80		10	110	0.70	22 500
4998100.MXISO	100		10	100	0.5	52 000
4998125.MXISO	125		16	100	0.41	78 000
4998150.MXISO	150		25	100 <sup>1</sup>	0.32	114 000
4998175.MXISO	175		25	100 <sup>1</sup>	0.24	207 000
4998200.MXISO	200		35	100 <sup>1</sup>	0.24	207 000

**Note 1:** Voltage drop measurements taken at 75 % of rated current.

**Note 2:** The typical I<sup>2</sup>t is an average value calculated from the breaking capacity tests by using the melting time before the arcing occurs.

### Dimensions

Dimensions in mm. Please refer to the outline drawing for dimensions and tolerances.

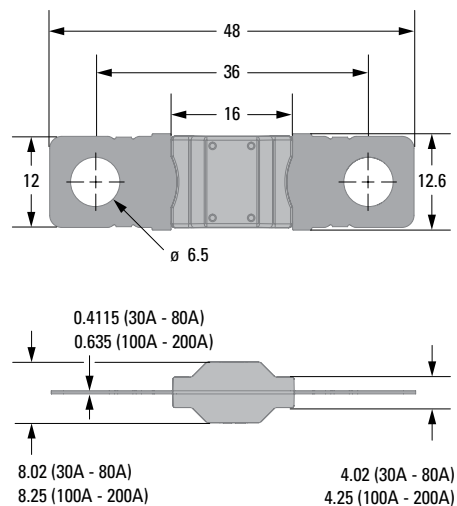

# MIDI ISO Series

## Bolt-down Fuses – Rated 70 V-SF36

### Time-Current Characteristic

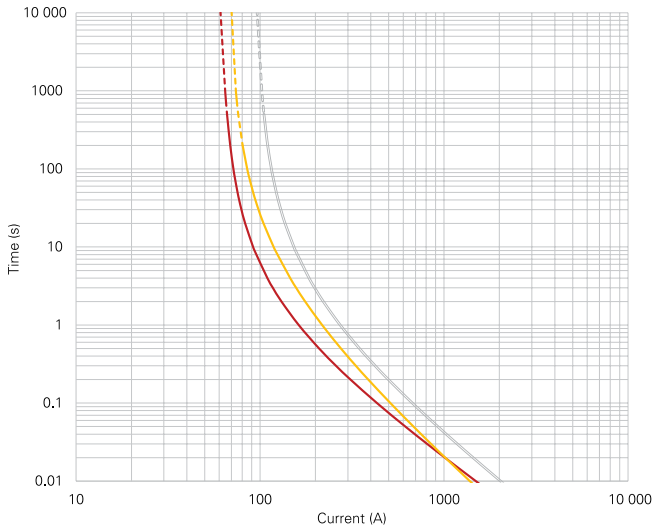

% of Rating	Opening Time Min. / Max. (s)
100	360 000 / -
135	300 / 3600
150	90 / 500
200	1 / 50
300	0.3 / 4
500	0.1 / 1
600	0.07 / 0.7

— 50 A  
— 60 A  
— 80 A

### Typical Derating Curves

Temperature security margin is 20%.

Please contact Littelfuse® for Details Regarding Derating Test Set Up.

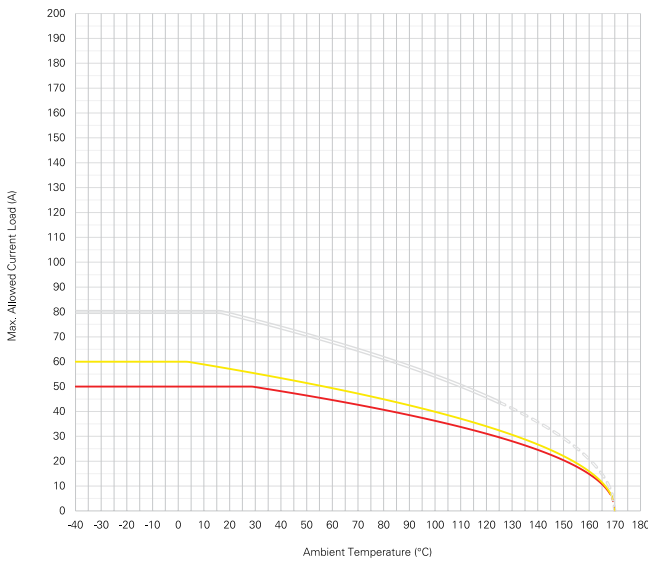

	Max. allowed current load (A) at ambient temperature based on typical derating						
	-40 °C	0 °C	20 °C	65 °C	85 °C	110 °C	125 °C
30 A	-	-	-	-	-	-	-
40 A	-	-	-	-	-	-	-
50 A	50	50	50	44	40	34	30
60 A	60	60	57	48	44	37	32
70 A	-	-	-	-	-	-	-
80 A	80	80	79	66	60	50	44
100 A	-	-	-	-	-	-	-
125 A	-	-	-	-	-	-	-
150 A	-	-	-	-	-	-	-
175 A	-	-	-	-	-	-	-
200 A	-	-	-	-	-	-	-

— 50 A  
— 60 A  
— 80 A

**Note:** The ratings without values are under development.

**Disclaimer Notice** - Information furnished is believed to be accurate and reliable. However, users should independently evaluate the suitability of and test each product selected for their own applications. Littelfuse products are not designed for, and may not be used in, all applications. Read complete Disclaimer Notice at <https://www.littelfuse.com/legal/disclaimers/product-disclaimer.aspx>