

# MEGA<sup>®</sup>+ Series

## Bolt-down Fuses – Rated 32 V DC

RoHS

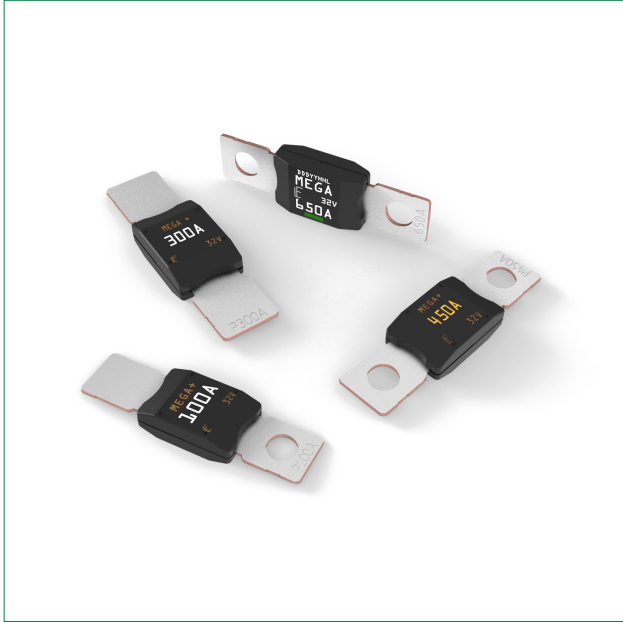

### Additional Information



Resources



Samples

### Description

The MEGA+<sup>®</sup> Fuse is designed for high current circuit protection up to 650A with “Diffusion Pill Technology.” The MEGA+<sup>®</sup> Fuse also provides time delay characteristics. Designed and patented by Littelfuse, the MEGA+<sup>®</sup> Fuse is ideal for battery and alternator protection application and other heavy gauge cables requiring ultrahigh current protection.

### Features & Benefits

- Mounting Torque M6 of  $9 \pm 1$  Nm (Max. allowed 14 Nm)
- Mounting Torque M8 of  $12 \pm 1$  Nm (Max. allowed 18 Nm)
- High-contrast color coding on housing aids identification
- Terminals in tin plated copper alloy
- Housing in PET-GF30FR (U.L.94 Flammability rating - V0)
- Refers to ISO 8820-5

### Applications

- Cars / SUVs
- Trucks
- Offroad vehicles
- Buses
- Watercraft as approved by Littelfuse<sup>®</sup>

[See Disclaimer Notice](#)

### Specifications

<b>Voltage Rating:</b>	32 V DC
<b>Interrupting Rating:</b>	2000 A @ 32 V DC
<b>Recommended Environmental Temperature:</b>	-40 °C to +125 °C
<b>Terminals Material:</b>	Tin-plated copper alloy
<b>Housing Material:</b>	PET-GF30FR (UL 94 Flammability rating of V0)
<b>Typical Weight per Fuse:</b>	12.0 g
<b>Mounting Torque M6:</b>	9 Nm $\pm$ 1 Nm (Max. allowed 14 Nm)
<b>Mounting Torque M8:</b>	12 Nm $\pm$ 1 Nm (Max. allowed 18 Nm)
<b>Refer to:</b>	ISO 8820-5

### Ordering Information

Part Name	Part Number	Current Rating (A)	Termination	Bolt Hole Qty.	Package Size
MEGA+	0298xxx.UXP-2M8	80 A - 500 A	M8 Bolt Down	2	500
	0298xxx.UXP-1M8	80 A - 500 A	M8 Bolt Down	1	500
	0298xxx.UXP-2M6	80 A - 500 A	M6 Bolt Down	2	500
	0298xxx.UXP-1M6	80 A - 500 A	M6 Bolt Down	1	500
	0298xxx.UXP-NH	80 A - 500 A	-	-	500
MEGA+ 650 A	0298650.U-2M8	650 A	M8 Bolt Down	2	500
	0298650.U-2M6	650 A	M6 Bolt Down	2	500

# MEGA<sup>®</sup>+ Series

## Bolt-down Fuses – Rated 32 V DC

### Ratings

Part Number	Current Rating (A)	Color Coding <sup>4</sup>	Test Cable Size (mm <sup>2</sup> )	Typ. Voltage Drop at 100% I <sub>r</sub> (mV)	Typ. Cold Resistance (mΩ)	Typ. I <sup>2</sup> t (A <sup>2</sup> s)
0298080_	80		10	77	0.66	22 900
02980100_	100		16	86	0.55	27 600
02980125_	125		16	79	0.41	78 000
02980150_	150		25	91	0.34	97 300
02980175_	175		25	77	0.28	205 500
02980200_	200		35	93	0.26	245 800
02980225_	225		35	84	0.21	135 300
02980250_	250		50	86	0.19	176 200
02980300_ <sup>2</sup>	300		70	45 <sup>3</sup>	0.16	378 900
02980350_ <sup>2</sup>	350		70	48 <sup>3</sup>	0.13	573 000
02980400_ <sup>2</sup>	400		70	52 <sup>3</sup>	0.12	844 400
02980450_ <sup>2</sup>	450		70	58 <sup>3</sup>	0.11	1 323 600
02980500_ <sup>2</sup>	500		70	58 <sup>3</sup>	0.09	1 850 200
02980650_ <sup>1,2</sup>	650		95	55 <sup>3</sup>	0.07	4 202 800

**1:** Not mentioned in ISO standards

**2:** Short Circuit Protector only

**3:** Voltage Drop measurements for short circuit protectors taken at 75% of rated current.

**4:** Color Code Applicable for the UXP-2M8 and UXP-2M6 versions only - Not applicable for UXP-1M6, UXP-1M8 and UXP-NH clinch versions that have the High Contrast Mark (White Color Only).

**Note:** The typical I<sup>2</sup>t is an average value calculated from the breaking capacity tests by using the melting time before the arcing occurs.

### Dimensions

Dimensions in mm. Please refer to the outline drawing for dimensions and tolerances.

**Marking Type “A”:** Color Code Rating Mark Applicable for the UXP-2M8 and UXP-2M6 versions only

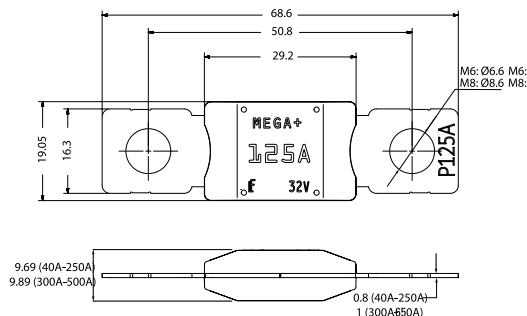

**Marking Type “B”:** High Contrast Mark (White Color Only - No Color Code) applicable for UXP-1M6, UXP-1M8 and UXP-NH clinch versions

UXP-1M6 & UXP-1M8 versions

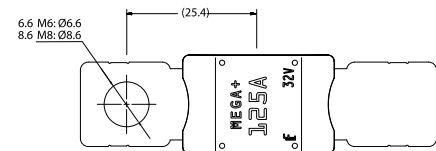

UXP-NH version

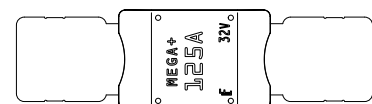

**Marking Type “C”:** Color Code Bar Hot Stamped applicable for U-2M8 and U-2M6 versions (650 A fuse rating) on one side only

U-2M6 & U-2M8 versions



# MEGA<sup>®</sup>+ Series

## Bolt-down Fuses – Rated 32 V DC

### Time-Current Characteristic

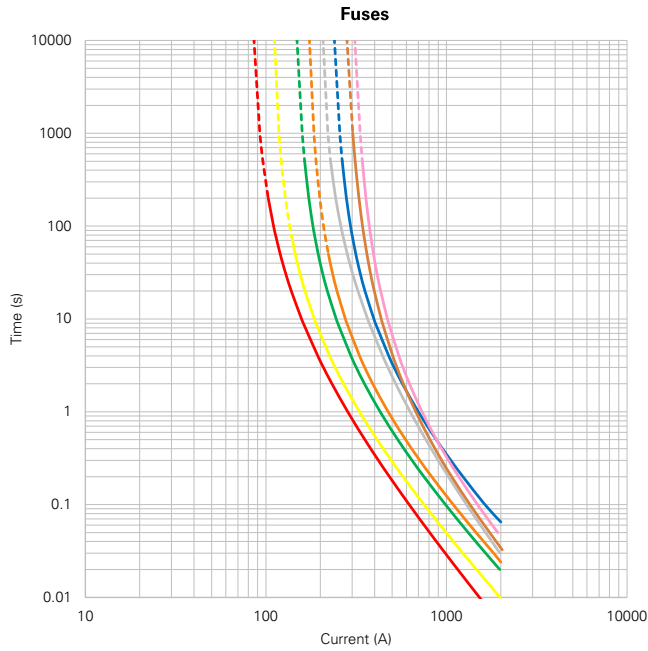

% of Rating	Opening Time Min. / Max. (s)			
	80 A - 250 A	300 A	350 A - 500 A	650 A
75	- / -	14 400 / -	14 400 / -	14 400 / -
100	14 400 / -	- / -	- / -	- / -
135	120 / 1800	- / -	- / -	- / -
150	20 / 450	- / -	- / -	- / -
200	1 / 15	1 / 15	1 / 15	1 / 15
350	0.3 / 5	0.5 / 5	0.5 / 5	0.5 / 5
500	- / -	0.1 / 2	0.1 / 2	- / -
600	0.1 / 1	0.1 / 1	- / -	0.1 / 1

- 80 A
- 100 A
- 125 A
- 150 A
- 175 A
- 200 A
- 225 A
- 250 A

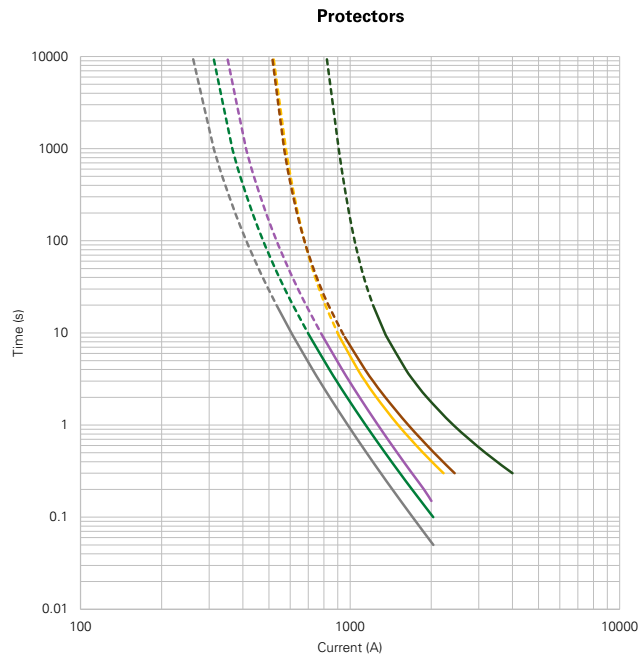

- 300 A
- 350 A
- 400 A
- 450 A
- 500 A
- 650 A

**Note:** Current recommendation may be impacted by the final condition of the application (terminals characteristics, wire size etc.). Please contact Littelfuse<sup>®</sup> for more information.

# MEGA<sup>®</sup>+ Series

## Bolt-down Fuses – Rated 32 V DC

### Typical Derating Curves

Temperature security margin is 20%.

Please contact Littelfuse<sup>®</sup> for Details Regarding Derating Test Set Up.

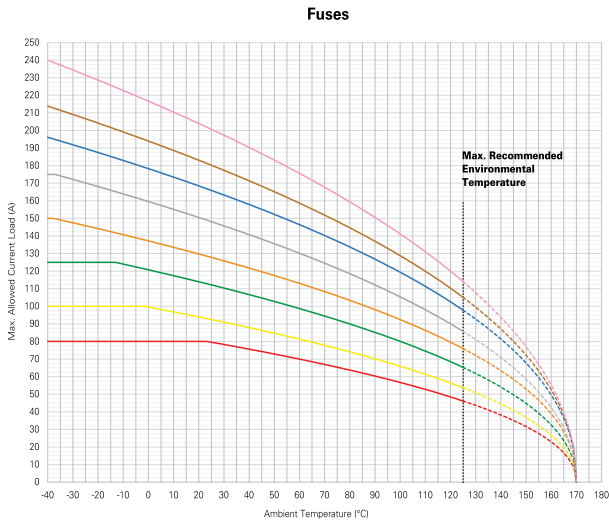

Max. allowed current load (A) at ambient temperature based on typical derating							
	-40 °C	0 °C	20 °C	65 °C	85 °C	110 °C	125 °C
<b>80 A</b>	80	80	80	68	62	53	46
<b>100 A</b>	100	100	94	80	72	61	54
<b>125 A</b>	125	121	114	97	88	75	65
<b>150 A</b>	150	137	130	111	101	86	76
<b>175 A</b>	175	160	151	127	115	98	86
<b>200 A</b>	196	178	168	143	130	111	98
<b>225 A</b>	214	194	183	155	141	120	105
<b>250 A</b>	240	217	204	172	155	131	114
<b>300 A</b>	225	225	225	212	191	162	141
<b>350 A</b>	263	263	263	235	213	180	157
<b>400 A</b>	300	300	300	237	214	181	158
<b>450 A</b>	338	338	333	280	252	213	185
<b>500 A</b>	375	360	340	288	261	222	194
<b>650 A</b>	486	435	407	338	303	253	217

- 80 A
- 100 A
- 125 A
- 150 A
- 175 A
- 200 A
- 225 A
- 250 A

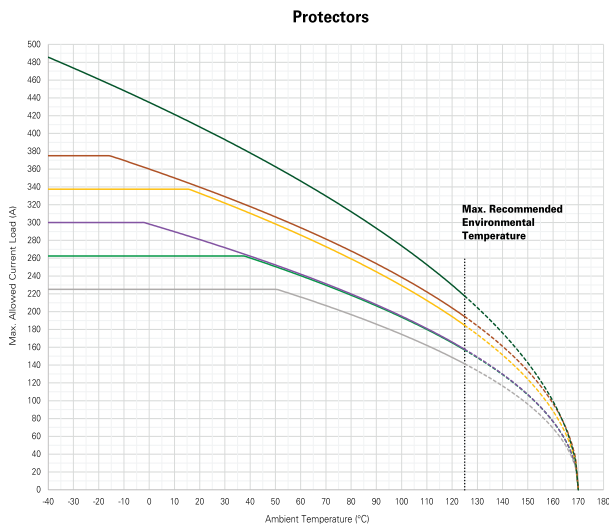

- 300 A
- 350 A
- 400 A
- 450 A
- 500 A
- 650 A

**Note:** Current recommendation may be impacted by the final condition of the application (terminals characteristics, wire size etc.). Please contact Littelfuse<sup>®</sup> for more information.

**Disclaimer Notice** - Information furnished is believed to be accurate and reliable. However, users should independently evaluate the suitability of and test each product selected for their own applications. Littelfuse products are not designed for, and may not be used in, all applications. Read complete Disclaimer Notice at <https://www.littelfuse.com/legal/disclaimers/product-disclaimer.aspx>