

# Soft Recovery Diode

## Type M0130#L200 to M0130#L250

### Absolute Maximum Ratings

	VOLTAGE RATINGS	MAXIMUM LIMITS	UNITS
$V_{RRM}$	Repetitive peak reverse voltage, (note 1)	2000-2500	V
$V_{RSM}$	Non-repetitive peak reverse voltage, (note 1)	2100-2600	V

	OTHER RATINGS	MAXIMUM LIMITS	UNITS
$I_{F(AV)M}$	Maximum average forward current, $T_{sink}=55^{\circ}C$ , (note 2)	130	A
$I_{F(AV)M}$	Maximum average forward current, $T_{sink}=100^{\circ}C$ , (note 2)	55	A
$I_{F(RMS)}$	Nominal RMS forward current, $T_{sink}=25^{\circ}C$ , (note 2)	269	A
$I_{F(d.c.)}$	D.C. forward current, $T_{sink}=25^{\circ}C$ , (note 3)	207	A
$I_{FSM}$	Peak non-repetitive surge $t_p=10ms$ , $V_{RM}=60\%V_{RRM}$ , (note 3)	2240	A
$I_{FSM2}$	Peak non-repetitive surge $t_p=10ms$ , $V_{RM}\leq 10V$ , (note 3)	2450	A
$I^2t$	$I^2t$ capacity for fusing $t_p=10ms$ , $V_{RM}=60\%V_{RRM}$ , (note 3)	$25\times 10^3$	$A^2s$
$I^2t$	$I^2t$ capacity for fusing $t_p=10ms$ , $V_{RM}\leq 10V$ , (note 3)	$30\times 10^3$	$A^2s$
$T_{j op}$	Operating temperature range	-40 to +125	$^{\circ}C$
$T_{stg}$	Storage temperature range	-40 to +150	$^{\circ}C$

Notes:-

- 1) De-rating factor of 0.13% per  $^{\circ}C$  is applicable for  $T_j$  below  $25^{\circ}C$ .
- 2) single phase; 50Hz,  $180^{\circ}$  half-sinewave.
- 3) Half-sinewave,  $125^{\circ}C$   $T_j$  initial.

### Characteristics

	PARAMETER	MIN.	TYP.	MAX.	TEST CONDITIONS (Note 1)	UNITS
V <sub>FM</sub>	Maximum peak forward voltage	-	-	1.64	I <sub>FM</sub> =280A	V
V <sub>T0</sub>	Threshold voltage	-	-	1.29		V
r <sub>T</sub>	Slope resistance	-	-	1.54		mΩ
V <sub>FRM</sub>	Maximum forward recovery voltage	-	-	150	di/dt = 1000A/μs	V
I <sub>RRM</sub>	Peak reverse current	-	-	20	Rated V <sub>RRM</sub>	mA
Q <sub>ra</sub>	Recovered charge, 50% Chord			265	I <sub>FM</sub> =1000A, t <sub>p</sub> =500μs, di/dt=200A/μs, V <sub>r</sub> =50V, 50% Chord.	μC
R <sub>thJC</sub>	Thermal resistance, junction to case	-	-	0.30		K/W
T	Mounting torque	11	-	14		Nm
W <sub>t</sub>	Weight	-	85	-		g

Notes:-

1) Unless otherwise indicated T<sub>j</sub>=125°C.

## Notes on Ratings and Characteristics

### 1.0 Voltage Grade Table

Voltage Grade	$V_{RRM}$ (V)	$V_{RSM}$ (V)	$V_R$ dc (V)
20	2000	2100	1250
25	2500	2600	1500

### 2.0 De-rating Factor

A blocking voltage de-rating factor of 0.13% per °C is applicable to this device for  $T_j$  below 25°C.

### 3.0 ABCD Constants

These constants (applicable only over current range of  $V_F$  characteristic in Figure 1) are the coefficients of the expression for the forward characteristic given below:

$$V_F = A + B \cdot \ln(I_F) + C \cdot I_F + D \cdot \sqrt{I_F}$$

where  $I_F$  = instantaneous forward current.

### 4.0 Reverse recovery ratings

- (i)  $Q_{rr}$  is based on 50%  $I_{RM}$  chord as shown in Fig.(a) below.



- (ii)  $Q_{rr}$  is based on a 150µs integration time.

i.e.

$$Q_{rr} = \int_0^{150\mu s} i_{rr} \cdot dt$$

(iii)

$$K \text{ Factor} = \frac{t_1}{t_2}$$

## 5.0 Reverse Recovery Loss

The following procedure is recommended for use where it is necessary to include reverse recovery loss.

From waveforms of recovery current obtained from a high frequency shunt (see Note 1) and reverse voltage present during recovery, an instantaneous reverse recovery loss waveform must be constructed. Let the area under this waveform be  $E$  joules per pulse. A new sink temperature can then be evaluated from:

$$T_{SINK} = T_{J(MAX)} - E \cdot [k + f \cdot R_{thJK}]$$

Where  $k = 0.2314$  ( $^{\circ}\text{C/W}$ )/s

$E$  = Area under reverse loss waveform per pulse in joules (W.s.)

$f$  = Rated frequency in Hz at the original sink temperature.

$R_{thJK}$  = d.c. thermal resistance ( $^{\circ}\text{C/W}$ )

The total dissipation is now given by:

$$W_{(tot)} = W_{(original)} + E \cdot f$$

### NOTE 1 - Reverse Recovery Loss by Measurement

This device has a low reverse recovered charge and peak reverse recovery current. When measuring the charge, care must be taken to ensure that:

(a) AC coupled devices such as current transformers are not affected by prior passage of high amplitude forward current.

(b) A suitable, polarised, clipping circuit must be connected to the input of the measuring oscilloscope to avoid overloading the internal amplifiers by the relatively high amplitude forward current signal.

(c) Measurement of reverse recovery waveform should be carried out with an appropriate critically damped snubber, connected across diode anode to cathode. The formula used for the calculation of this snubber is shown below:

$$R^2 = 4 \cdot \frac{V_r}{C_s \cdot di/dt}$$

Where:  $V_r$  = Commutating source voltage

$C_s$  = Snubber capacitance

$R$  = Snubber resistance

## 6.0 Snubber Components

When selecting snubber components, care must be taken not to use excessively large values of snubber capacitor or excessively small values of snubber resistor. Such excessive component values may lead to device damage due to the large resultant values of snubber discharge current. If required, please consult the factory for assistance.

## 7.0 Computer Modelling Parameters

### 7.1 Device Dissipation Calculations

$$I_{AV} = \frac{-V_{T0} + \sqrt{V_{T0}^2 + 4 \cdot ff^2 \cdot r_T \cdot W_{AV}}}{2 \cdot ff^2 \cdot r_T}$$

Where  $V_{T0} = 1.29V$ ,  $r_T = 1.54m\Omega$

$ff$  = form factor (normally unity for fast diode applications)

$$W_{AV} = \frac{\Delta T}{R_{th}}$$

$$\Delta T = T_{j(MAX)} - T_K$$

### 7.2 Calculation of $V_F$ using ABCD Coefficients

The forward characteristic  $I_F$  Vs  $V_F$ , on page 6 is represented in two ways;

- (i) the well established  $V_{T0}$  and  $r_T$  tangent used for rating purposes and
- (ii) a set of constants A, B, C, and D forming the coefficients of the representative equation for  $V_F$  in terms of  $I_F$  given below:

$$V_F = A + B \cdot \ln(I_F) + C \cdot I_F + D \cdot \sqrt{I_F}$$

The constants, derived by curve fitting software, are given in this report for both hot and cold characteristics. The resulting values for  $V_F$  agree with the true device characteristic over a current range, which is limited to that plotted.

	25°C Coefficients	125°C Coefficients
A	0.5114576	-2.731242
B	0.2148281	1.077503
C	$0.94676 \times 10^{-3}$	$2.205207 \times 10^{-3}$
D	-0.02107342	-0.1451473

## 8.0 Frequency Ratings

The curves illustrated in figures 7 to 15 are for guidance only and are superseded by the maximum ratings shown on page 1.

### 9.0 Square wave ratings

These ratings are given for load component rate of rise of forward current of 100 and 500 A/ $\mu$ s.

### 10.0 Duty cycle lines

The 100% duty cycle is represented on all the ratings by a straight line. Other duties can be included as parallel to the first.

**Curves**

Figure 1 – Forward characteristics of Limit device

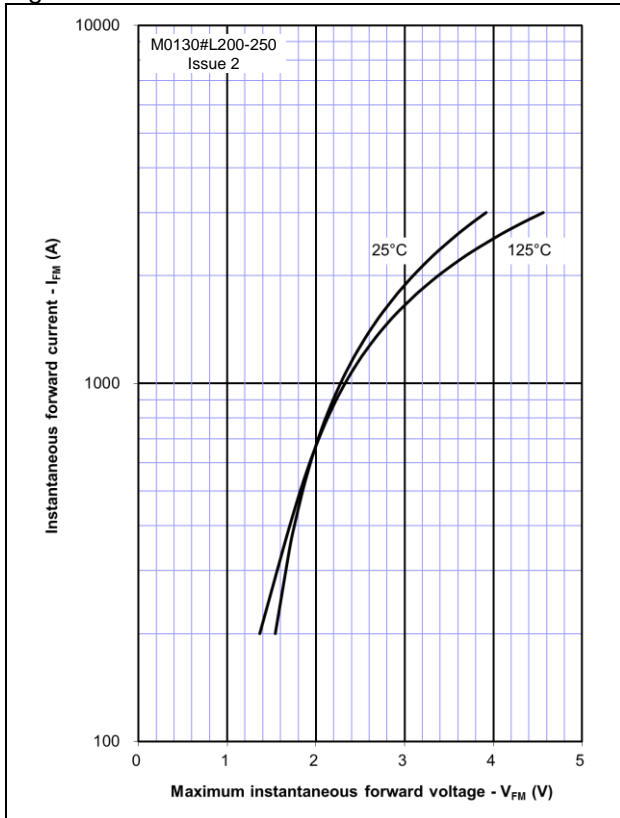

Figure 2 – Maximum forward recovery voltage

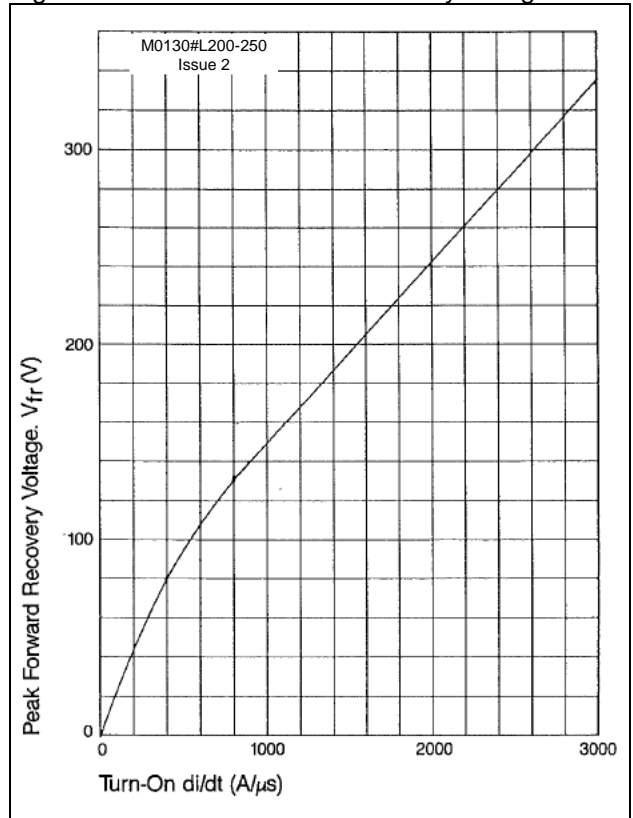

Figure 3 - Recovered charge,  $Q_{rr}$

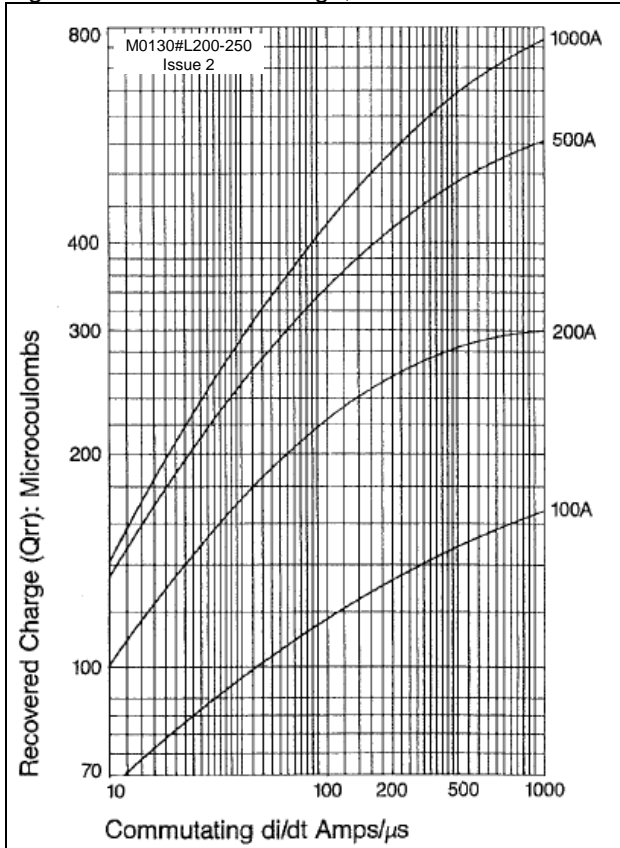

Figure 4 - Recovered charge,  $Q_{ra}$  (50% chord)

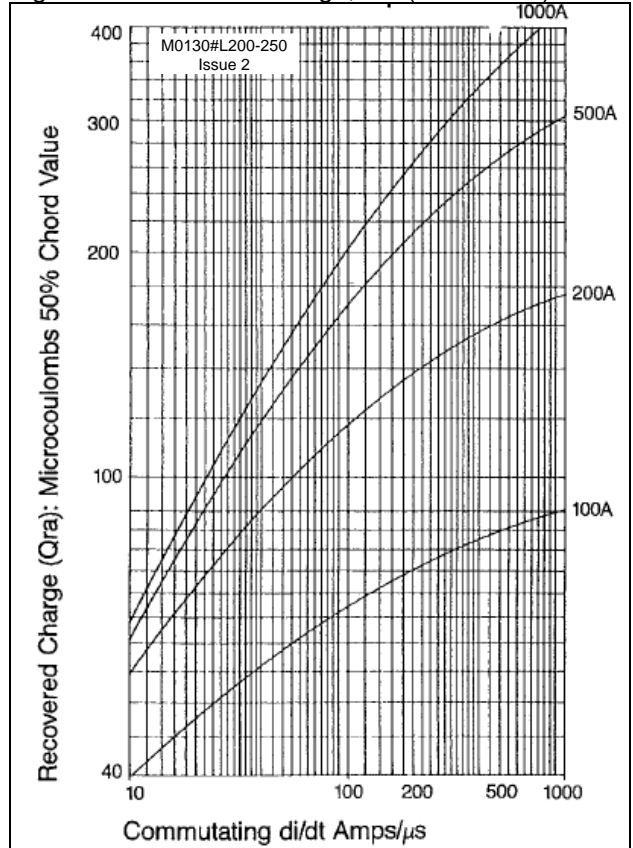

Figure 5 - Reverse recovery energy per pulse

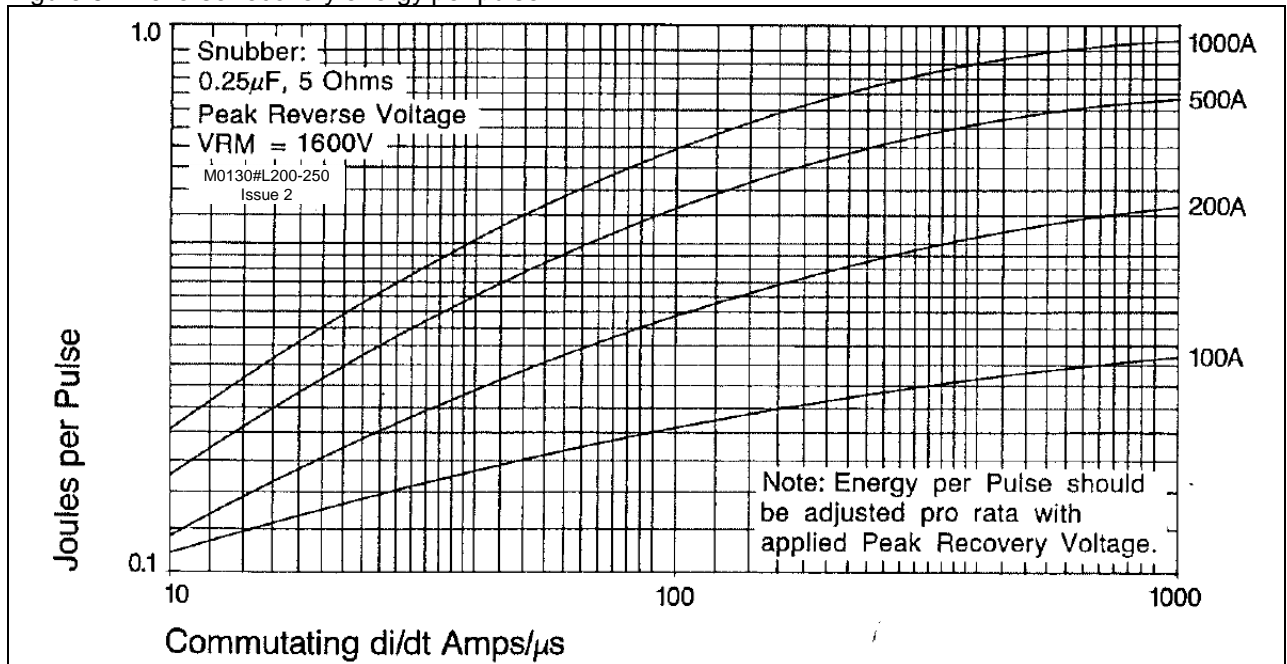

Figure 6 – Maximum reverse current,  $I_{rm}$

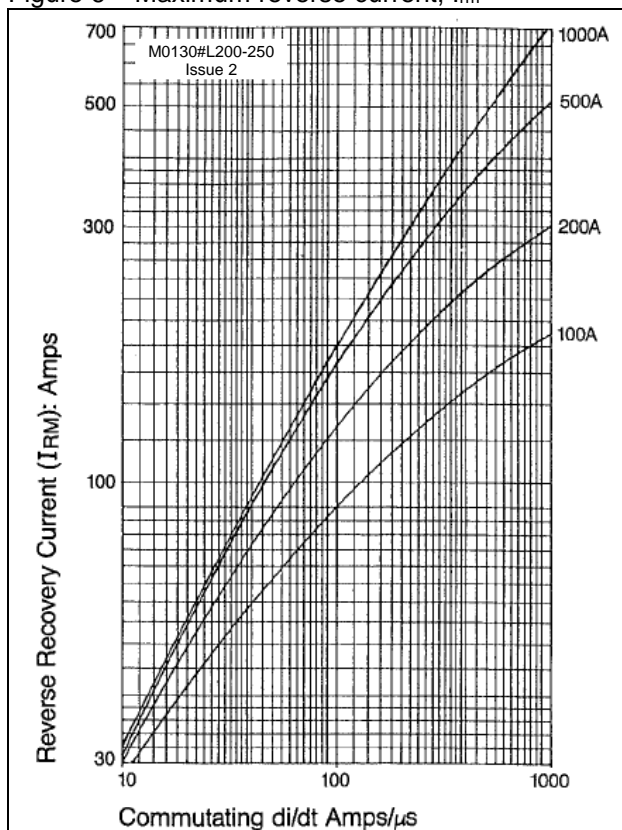

Figure 7 - Sine wave energy per pulse

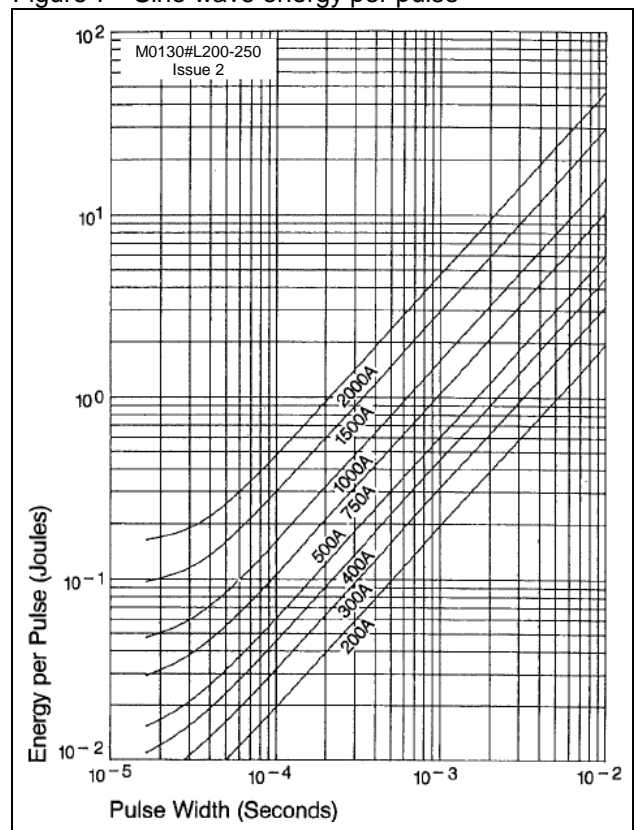

Figure 8 - Sine wave frequency vs. pulse width,  $T_{case} - 60^{\circ}C$

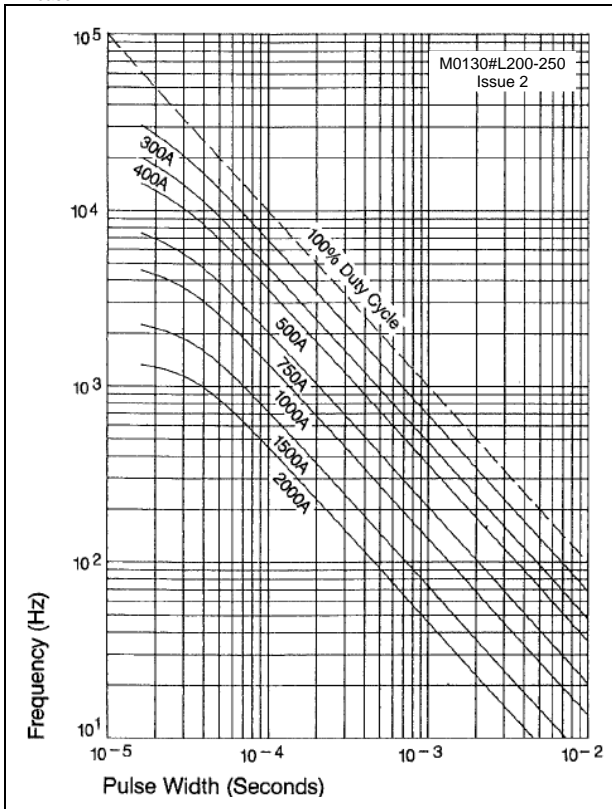

Figure 9 - Sine wave frequency vs. pulse width,  $T_{case} - 90^{\circ}C$

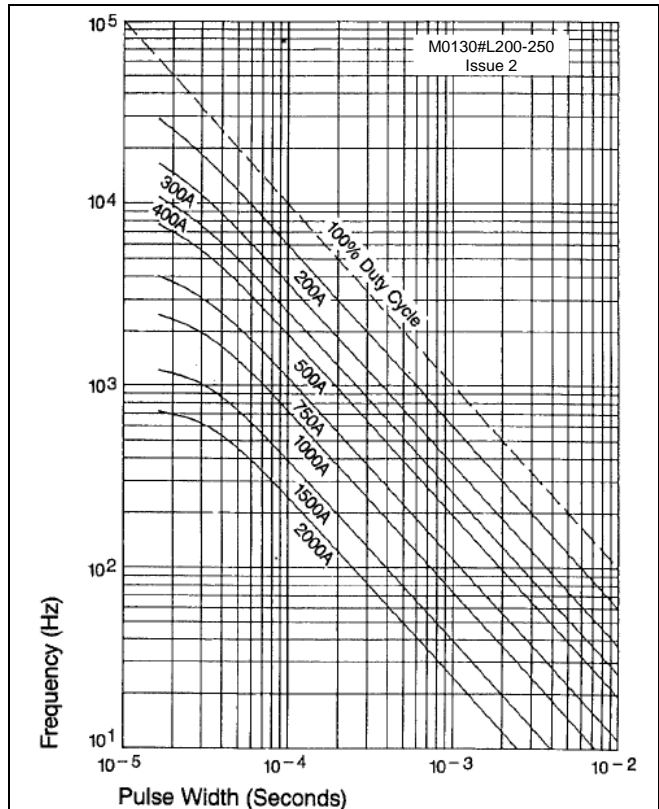

Figure 10 - Square wave energy per pulse,  $T_{case} - 60^{\circ}C$

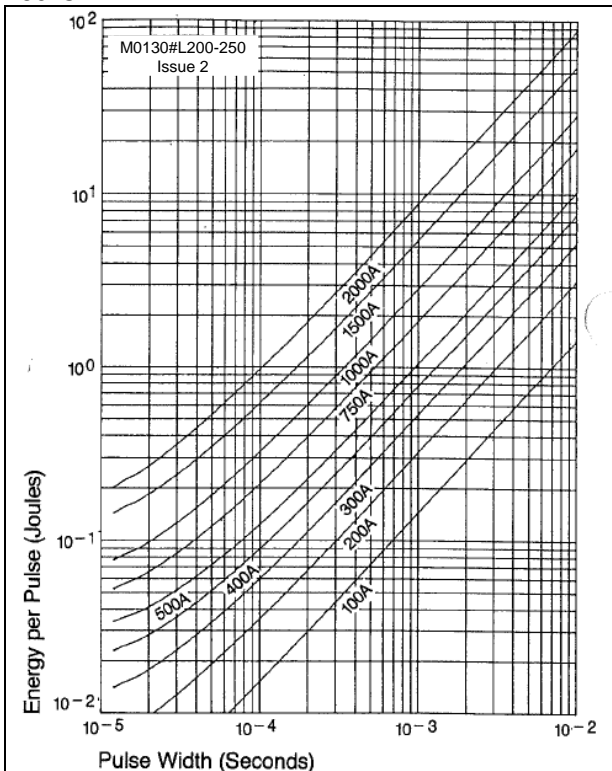

Figure 11 - Square wave energy per pulse,  $T_{case} - 90^{\circ}C$

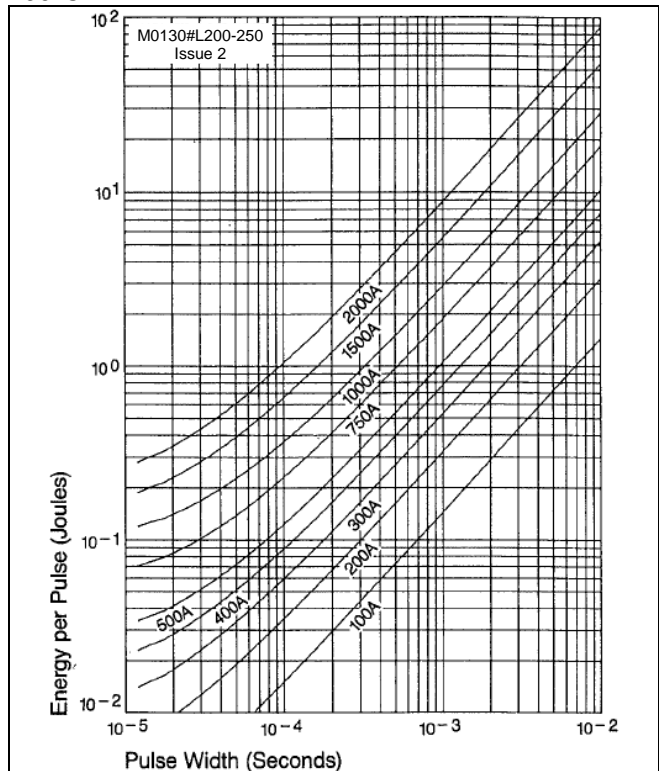



Figure 12 - Square wave frequency vs. pulse width,  
 $T_{case} - 60^{\circ}C$ ,  $di/dt - 500A/\mu s$

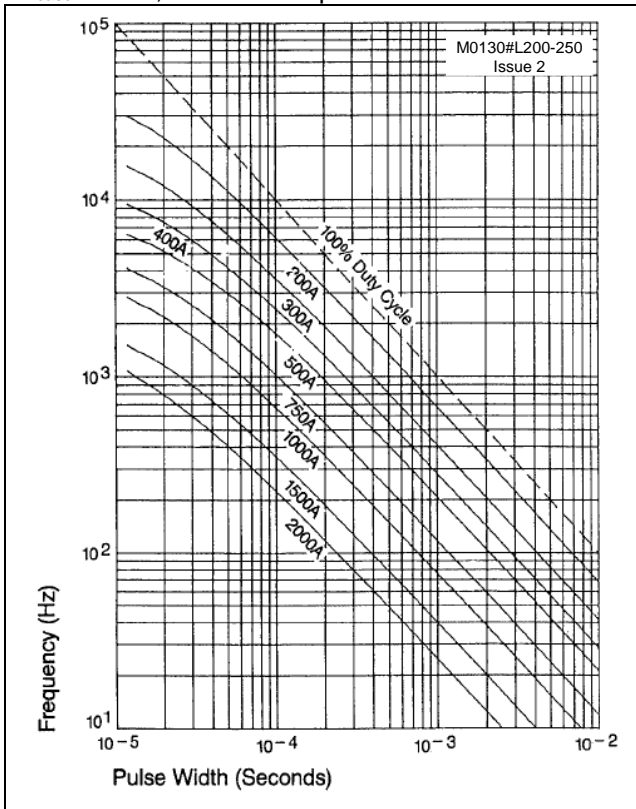

Figure 13 - Square wave frequency vs. pulse width,  
 $T_{case} - 90^{\circ}C$ ,  $di/dt - 500A/\mu s$

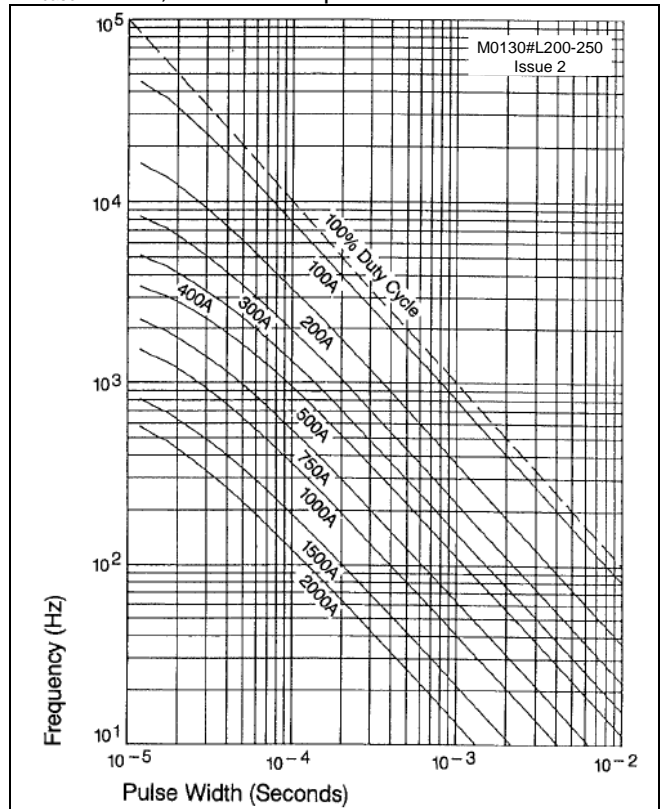

Figure 14 - Square wave frequency vs. pulse width,  
 $T_{case} - 60^{\circ}C$ ,  $di/dt - 1000A/\mu s$

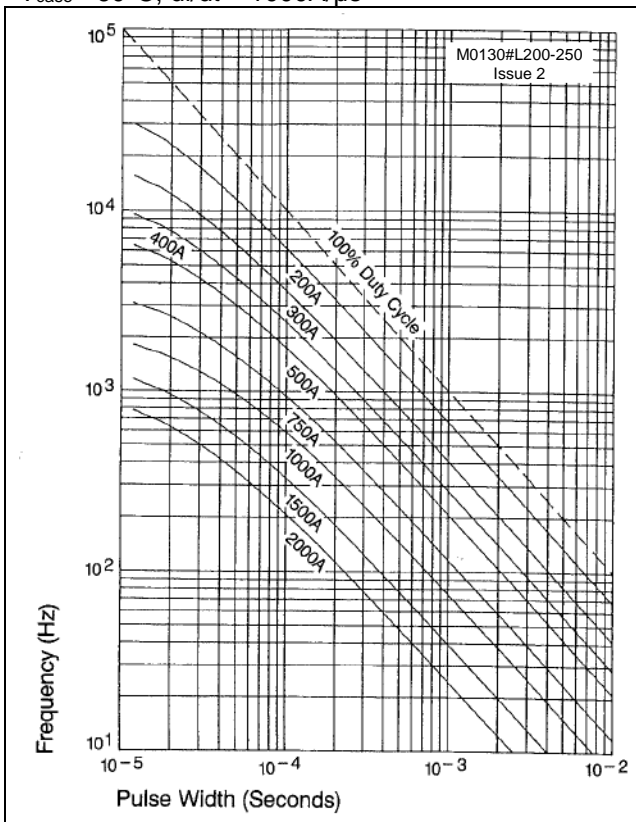

Figure 15 - Square wave frequency vs. pulse width,  
 $T_{case} - 90^{\circ}C$ ,  $di/dt - 1000A/\mu s$

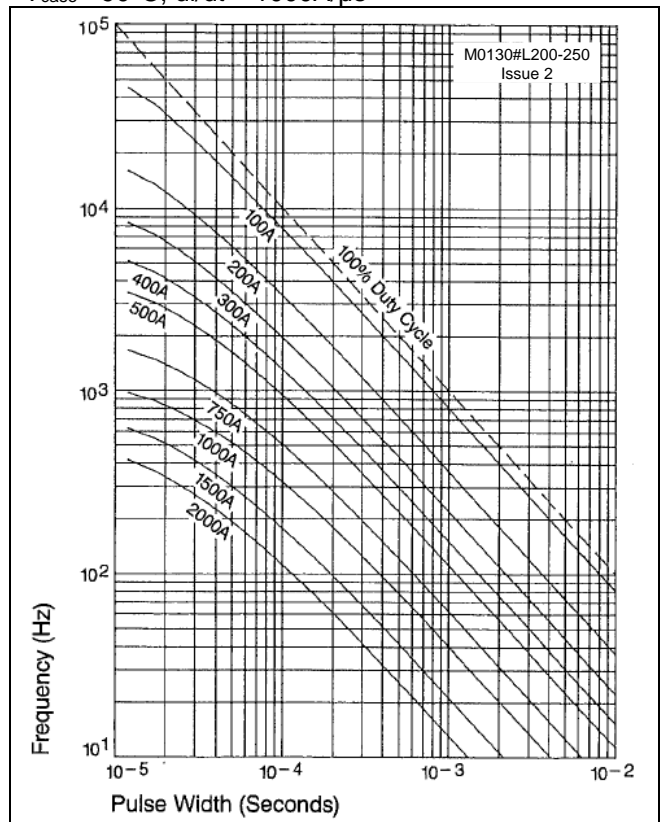

Figure 16 – Maximum surge and I<sup>2</sup>t ratings

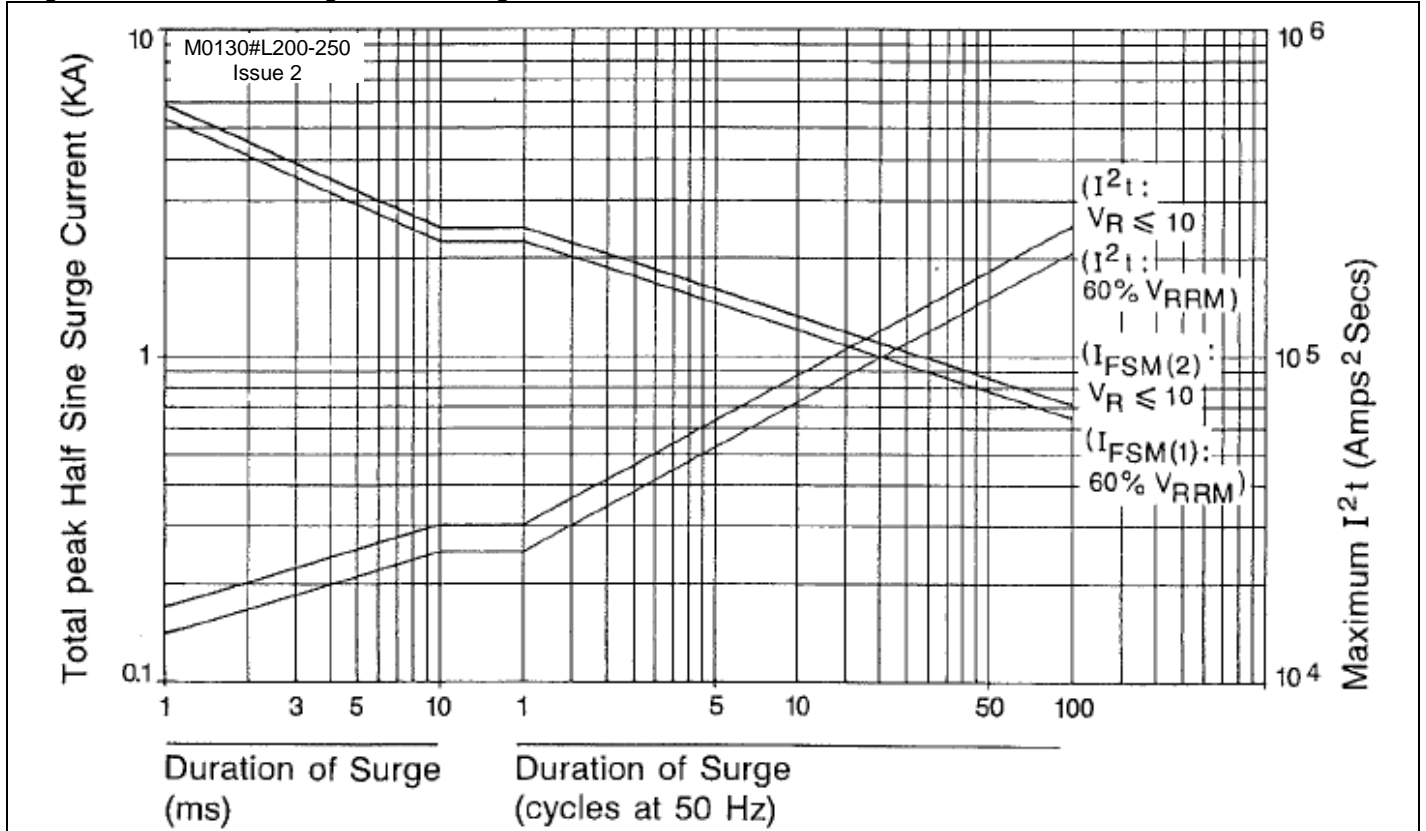
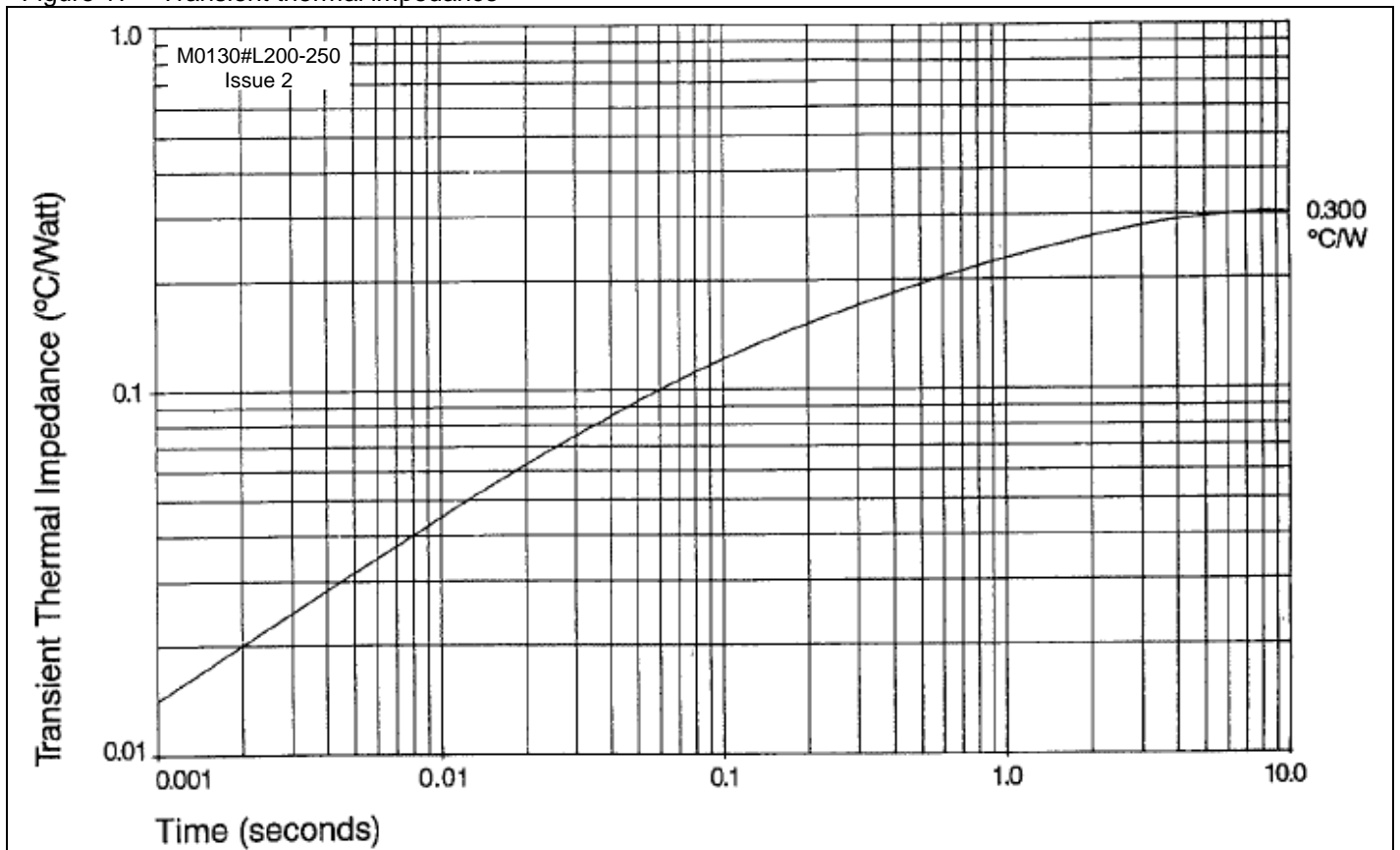
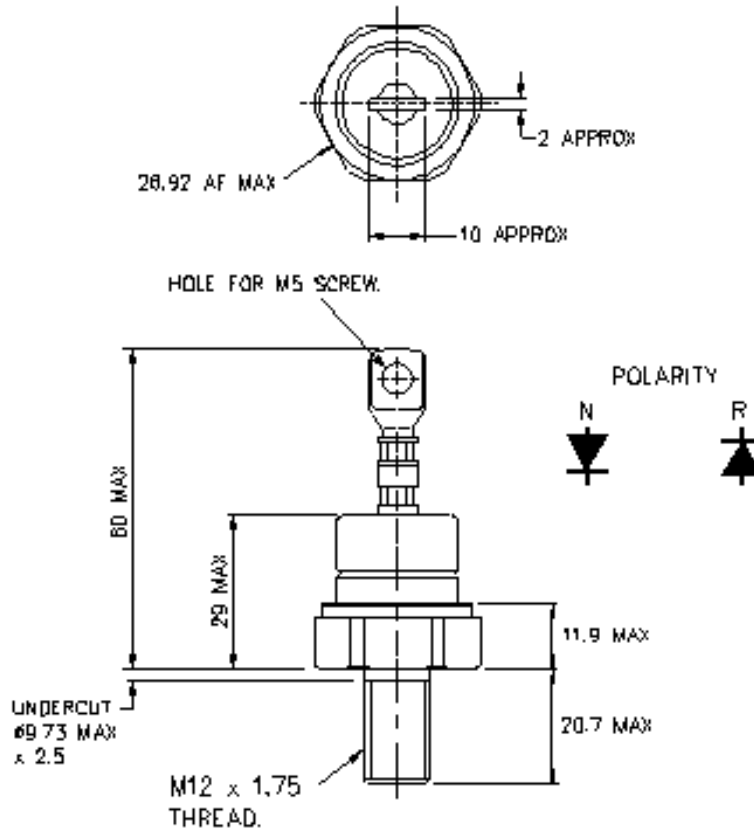

Figure 17 – Transient thermal impedance



**Outline Drawing & Ordering Information**



W20 – 100A303

**ORDERING INFORMATION**

(Please quote 10 digit code as below)

<b>M0130</b>	<b>#</b>	<b>L</b>	<b>◆◆</b>	<b>0</b>
Fixed Type Code	Polarity S – Cathode stud R – Anode stud	Fixed outline code	Voltage code $V_{RRM}/100$ 20-25	Fixed code

Order code: M0130RL200 – 2000V  $V_{RRM}$ , M12 stud base, stud anode.

**IXYS Semiconductor GmbH**  
Edisonstraße 15  
D-68623 Lampertheim  
Tel: +49 6206 503-0  
Fax: +49 6206 503-627  
E-mail: [marcom@ixys.de](mailto:marcom@ixys.de)



**IXYS UK Westcode Ltd**  
Langley Park Way, Langley Park,  
Chippenham, Wiltshire, SN15 1GE.  
Tel: +44 (0)1249 444524  
Fax: +44 (0)1249 659448  
E-mail: [sales@ixysuk.com](mailto:sales@ixysuk.com)

**IXYS Corporation**  
1590 Buckeye Drive  
Milpitas CA 95035-7418  
Tel: +1 (408) 547 9000  
Fax: +1 (408) 496 0670  
E-mail: [sales@ixys.net](mailto:sales@ixys.net)

[www.ixysuk.com](http://www.ixysuk.com)

[www.ixys.com](http://www.ixys.com)

**IXYS Long Beach, Inc**  
IXYS Long Beach, Inc  
2500 Mira Mar Ave, Long Beach  
CA 90815  
Tel: +1 (562) 296 6584  
Fax: +1 (562) 296 6585  
E-mail: [service@ixyslongbeach.com](mailto:service@ixyslongbeach.com)

The information contained herein is confidential and is protected by Copyright. The information may not be used or disclosed except with the written permission of and in the manner permitted by the proprietors IXYS UK Westcode Ltd.

© IXYS UK Westcode Ltd.

In the interest of product improvement, IXYS UK Westcode Ltd reserves the right to change specifications at any time without prior notice.

Devices with a suffix code (2-letter, 3-letter or letter/digit/letter combination) added to their generic code are not necessarily subject to the conditions and limits contained in this report.



---

Disclaimer Notice - Information furnished is believed to be accurate and reliable. However, users should independently evaluate the suitability of and test each product selected for their own applications. Littelfuse products are not designed for, and may not be used in, all applications. Read complete Disclaimer Notice at [www.littelfuse.com/disclaimer-electronics](http://www.littelfuse.com/disclaimer-electronics).