



## Rectifier Diode

### Types W1032LC500 to W1032LC600

(Old Part Number: SW50-60CXC350)

#### Absolute Maximum Ratings

|                  | VOLTAGE RATINGS                               | MAXIMUM LIMITS | UNITS |
|------------------|---|----------------|-------|
| V <sub>RRM</sub> | Repetitive peak reverse voltage, (note 1)     | 5000-6000      | V     |
| V <sub>RSM</sub> | Non-repetitive peak reverse voltage, (note 1) | 5100-6100      | V     |

|                      | OTHER RATINGS  | MAXIMUM LIMITS      | UNITS            |
|----------------------|--|---------------------|------------------|
| I <sub>F(AV)M</sub>  | Maximum average forward current, T <sub>sink</sub> =55°C, (note 2)   | 1032                | A                |
| I <sub>F(AV)M</sub>  | Maximum average forward current, T <sub>sink</sub> =100°C, (note 2)  | 689                 | A                |
| I <sub>F(AV)M</sub>  | Nominal RMS forward current, T <sub>sink</sub> =100°C, (note 3)  | 432                 | A                |
| I <sub>F(RMS)M</sub> | Nominal RMS forward current, T <sub>sink</sub> =25°C, (note 2)   | 1912                | A                |
| I <sub>F(d.c.)</sub> | D.C. forward current, T <sub>sink</sub> =25°C, (note 4)  | 1717                | A                |
| I <sub>FSM</sub>     | Peak non-repetitive surge t <sub>p</sub> =10ms, V <sub>rm</sub> =0.6V <sub>RRM</sub> , (note 5)            | 7200                | A                |
| I <sub>FSM2</sub>    | Peak non-repetitive surge t <sub>p</sub> =10ms, V <sub>rm</sub> ≤10V, (note 5)                             | 8000                | A                |
| I <sup>2</sup> t     | I <sup>2</sup> t capacity for fusing t <sub>p</sub> =10ms, V <sub>rm</sub> =0.6V <sub>RRM</sub> , (note 5) | 259×10 <sup>3</sup> | A <sup>2</sup> s |
| I <sup>2</sup> t     | I <sup>2</sup> t capacity for fusing t <sub>p</sub> =10ms, V <sub>rm</sub> ≤10V, (note 5)                  | 320×10 <sup>3</sup> | A <sup>2</sup> s |
| T <sub>j op</sub>    | Operating temperature range  | -40 to +150         | °C               |
| T <sub>stg</sub>     | Storage temperature range  | -55 to +150         | °C               |

#### Notes:-

- 1) De-rating factor of 0.13% per °C is applicable for T<sub>j</sub> below 25°C.
- 2) Double side cooled, single phase; 50Hz, 180° half-sinewave.
- 3) Single side cooled, single phase; 50Hz, 180° half-sinewave.
- 4) Double side cooled.
- 5) Half-sinewave, 150°C T<sub>j</sub> initial.

### Characteristics

|            | PARAMETER                                | MIN. | TYP. | MAX.  | TEST CONDITIONS (Note 1)                                   | UNITS      |
|------------|--|------|------|-------|--|------------|
| $V_{FM}$   | Maximum peak forward voltage             | -    | -    | 2.7   | $I_{TM}=2420A$   | V          |
| $V_{T0}$   | Threshold voltage                        | -    | -    | 1.0   |  | V          |
| $r_T$      | Slope resistance                         | -    | -    | 0.702 |  | m $\Omega$ |
| $I_{RRM}$  | Peak reverse current                     | -    | -    | 30    | Rated $V_{RRM}$  | mA         |
| $I_{RRM}$  | Peak reverse current                     | -    | -    | 30    | Rated $V_{RRM}$ , $T_j=25^\circ C$                         | mA         |
| $Q_{rr}$   | Total recovered charge                   | -    | 4400 | -     | $I_{FM}=1000A$ , $t_p=1ms$ , $di/dt=10A/\mu s$ , $V_r=50V$ | $\mu C$    |
| $Q_{ra}$   | Reverse recovery charge (50% chord)      | -    | 1900 | 2050  |  | $\mu C$    |
| $I_{rm}$   | Reverse recovery current                 | -    | 125  | -     |  | A          |
| $t_{rr}$   | Reverse recovery time (50% chord)        | -    | 30   | -     |  | $\mu s$    |
| $R_{thJK}$ | Thermal resistance, junction to heatsink | -    | -    | 0.033 | Double side cooled   | K/W        |
|            |  | -    | -    | 0.066 | Single side cooled   | K/W        |
| F          | Mounting force                           | 10   | -    | 20    |  | kN         |
| $W_t$      | Weight                                   | -    | 340  | -     |  | g          |

Notes:-

1) Unless otherwise indicated  $T_j=150^\circ C$ .

## Notes on Ratings and Characteristics

### 1.0 Voltage Grade Table

| Voltage Grade | V <sub>RRM</sub><br>V | V <sub>RSM</sub><br>V | V <sub>R</sub><br>DC V |
|---------------|-----------------------|-----------------------|------------------------|
| 50            | 5000                  | 5100                  | 2200                   |
| 52            | 5200                  | 5300                  | 2240                   |
| 54            | 5400                  | 5500                  | 2280                   |
| 56            | 5600                  | 5700                  | 2320                   |
| 58            | 5800                  | 5900                  | 2360                   |
| 60            | 6000                  | 6100                  | 2400                   |

### 2.0 De-rating Factor

A blocking voltage de-rating factor of 0.13%/°C is applicable to this device for T<sub>j</sub> below 25°C.

### 3.0 Snubber Components

When selecting snubber components, care must be taken not to use excessively large values of snubber capacitor or excessively small values of snubber resistor. Such excessive component values may lead to device damage due to the large resultant values of snubber discharge current. If required, please consult the factory for assistance.

### 4.0 Computer Modelling Parameters

#### 4.1 Device Dissipation Calculations

$$I_{AV} = \frac{-V_0 + \sqrt{V_0^2 + 4 \cdot ff^2 \cdot r_s \cdot W_{AV}}}{2 \cdot ff^2 \cdot r_s} \quad \text{and:} \quad W_{AV} = \frac{\Delta T}{R_{th}}$$

$$\Delta T = T_{j \max} - T_{Hs}$$

Where V<sub>0</sub>=1.0V, r<sub>s</sub>=0.702mΩ,

R<sub>th</sub> = Supplementary thermal impedance, see table below.

ff = Form factor, see table below.

| Supplementary Thermal Impedance (at 50Hz operating frequency) |               |                |                  |       |
|---|---------------|----------------|------------------|-------|
| Conduction Angle  | 6 phase (60°) | 3 phase (120°) | Half wave (180°) | d.c.  |
| Square wave Double Side Cooled                                | 0.045         | 0.040          | 0.036            | 0.033 |
| Square wave Single Side Cooled                                | 0.081         | 0.075          | 0.070            | 0.066 |
| Sine wave Double Side Cooled                                  | 0.042         | 0.038          | 0.034            |       |
| Sine wave Single Side Cooled                                  | 0.079         | 0.072          | 0.067            |       |

| Form Factors     |               |                |                  |      |
|------------------|---------------|----------------|------------------|------|
| Conduction Angle | 6 phase (60°) | 3 phase (120°) | Half wave (180°) | d.c. |
| Square wave      | 2.45          | 1.73           | 1.41             | 1    |
| Sine wave        | 2.78          | 1.88           | 1.57             |      |

#### 4.2 Calculating $V_F$ using ABCD Coefficients

The forward characteristic  $I_F$  vs.  $V_F$ , on page 5 is represented in two ways;

- (i) the well established  $V_{T0}$  and  $r_T$  tangent used for rating purposes and
- (ii) a set of constants A, B, C, D, forming the coefficients of the representative equation for  $V_F$  in terms of  $I_F$  given below:

$$V_F = A + B \cdot \ln(I_F) + C \cdot I_F + D \cdot \sqrt{I_F}$$

The constants, derived by curve fitting software, are given below for both hot and cold characteristics. The resulting values for  $V_F$  agree with the true device characteristic over a current range, which is limited to that plotted.

| 25°C Coefficients |                            | 150°C Coefficients |                            |
|-------------------|----------------------------|--------------------|----------------------------|
| A                 | 0.786727                   | A                  | 0.5103767                  |
| B                 | 0.06700378                 | B                  | 0.1000737                  |
| C                 | $5.405371 \times 10^{-4}$  | C                  | $7.364539 \times 10^{-4}$  |
| D                 | $-5.209484 \times 10^{-3}$ | D                  | $-7.568512 \times 10^{-3}$ |

#### 4.3 D.C. Thermal Impedance Calculation

$$r_t = \sum_{p=1}^{p=n} r_p \cdot \left( 1 - e^{\frac{-t}{\tau_p}} \right)$$

Where  $p = 1$  to  $n$ ,  $n$  is the number of terms in the series and:

$t$  = Duration of heating pulse in seconds.

$r_t$  = Thermal resistance at time  $t$ .

$r_p$  = Amplitude of  $p$ th term.

$\tau_p$  = Time Constant of  $r$ th term.

| D.C. Double Side Cooled |            |                           |                           |                           |
|-------------------------|------------|---------------------------|---------------------------|---------------------------|
| Term                    | 1          | 2                         | 3                         | 4                         |
| $r_p$                   | 0.01771901 | $4.240625 \times 10^{-3}$ | $6.963806 \times 10^{-3}$ | $3.043661 \times 10^{-3}$ |
| $\tau_p$                | 0.7085781  | 0.1435833                 | 0.03615196                | $2.130842 \times 10^{-3}$ |

| D.C. Single Side Cooled |            |                           |                           |                          |                           |
|-------------------------|------------|---------------------------|---------------------------|--------------------------|---------------------------|
| Term                    | 1          | 2                         | 3                         | 4                        | 5                         |
| $r_p$                   | 0.04013371 | $8.832199 \times 10^{-3}$ | $9.210899 \times 10^{-3}$ | $3.73647 \times 10^{-3}$ | $2.594797 \times 10^{-3}$ |
| $\tau_p$                | 4.073105   | 1.196877                  | 0.09882439                | 0.01585017               | $2.077263 \times 10^{-3}$ |

### 5.0 Reverse recovery ratings

(i)  $Q_{rr}$  is based on 50%  $I_{RM}$  chord as shown in Fig. 1

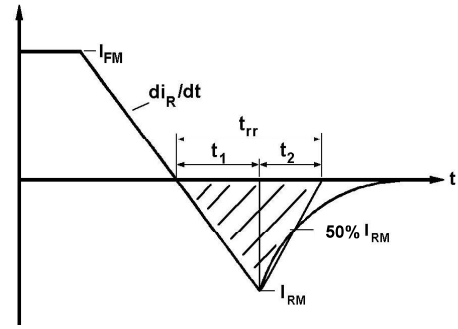

Fig. 1

(ii)  $Q_{rr}$  is based on a  $150\mu s$  integration time i.e.

$$Q_{rr} = \int_0^{150\mu s} i_{rr} \cdot dt$$

(ii)  $K \text{ Factor} = \frac{t_1}{t_2}$

**Curves**

Figure 1 – Forward characteristics of Limit device

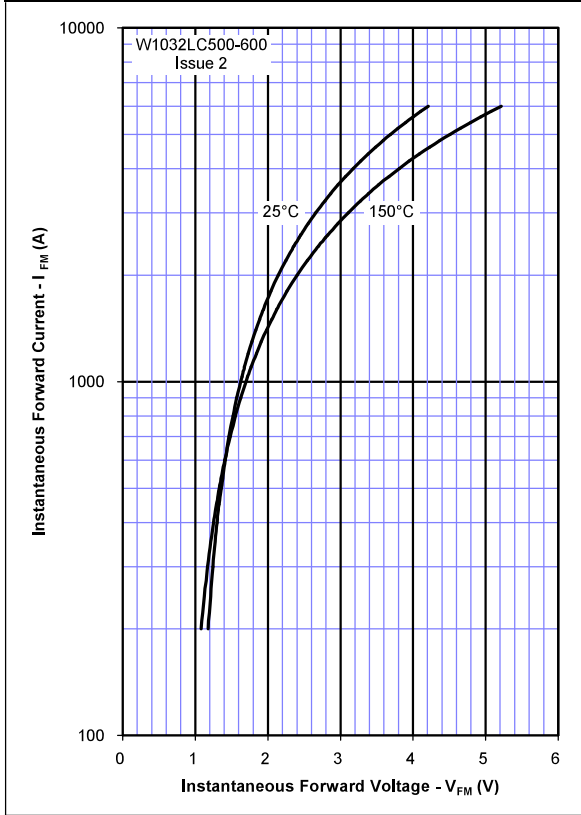

Figure 2 – Transient Thermal Impedance

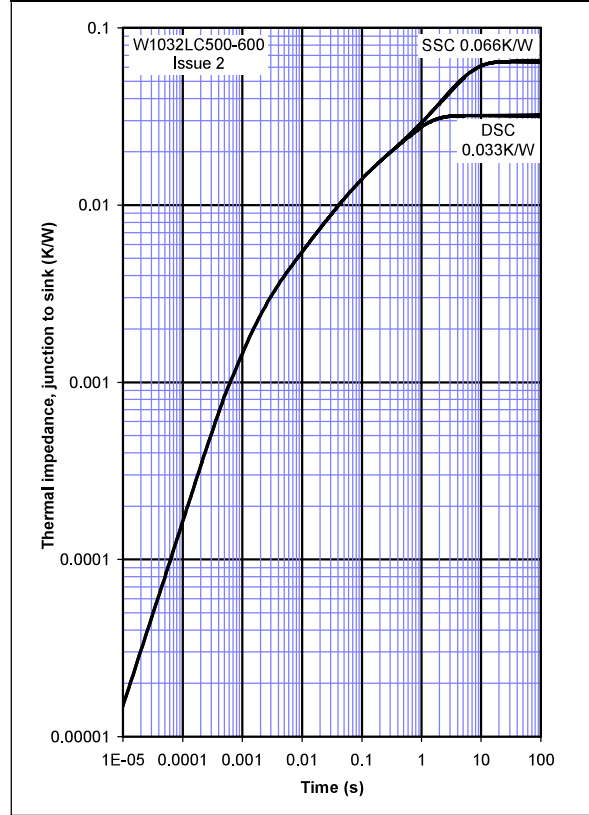

Figure 3 – Maximum surge and I<sup>2</sup>t Ratings

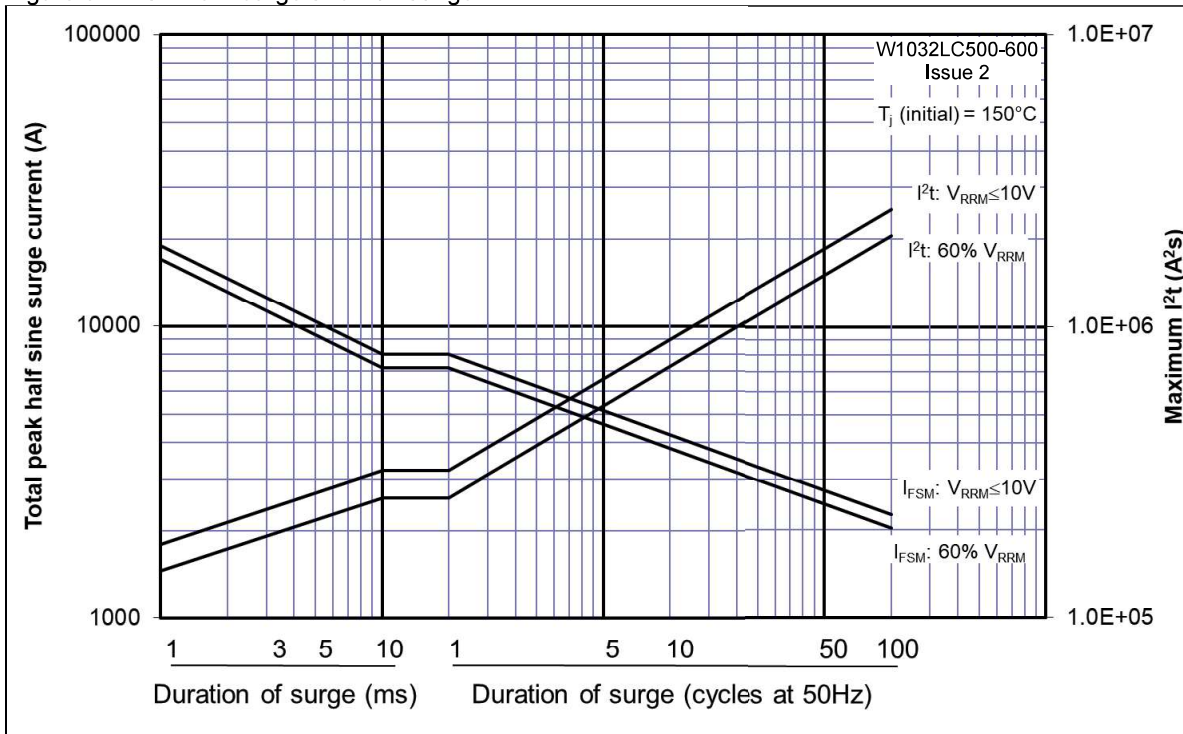

Figure 4 – Total recovered charge,  $Q_{rr}$

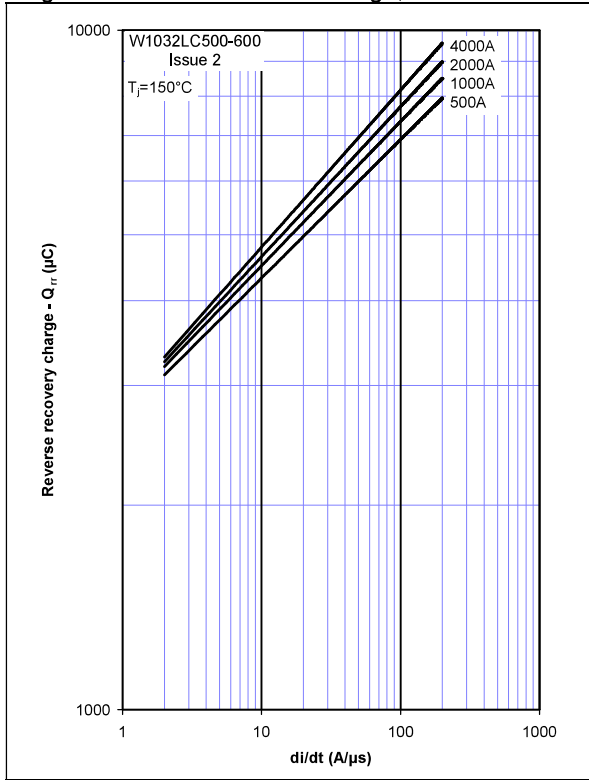

Figure 5 – Recovered charge,  $Q_{ra}$  (50% chord)

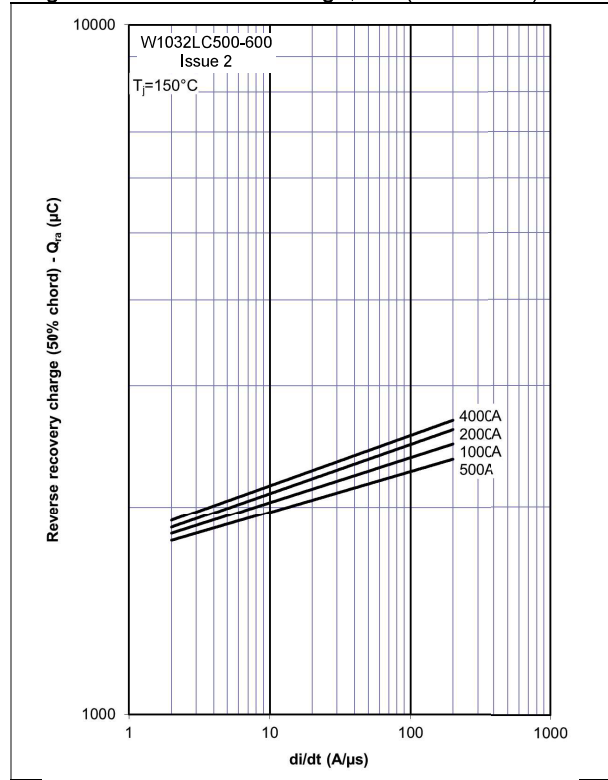

Figure 6 – Peak reverse recovery current,  $I_{rm}$

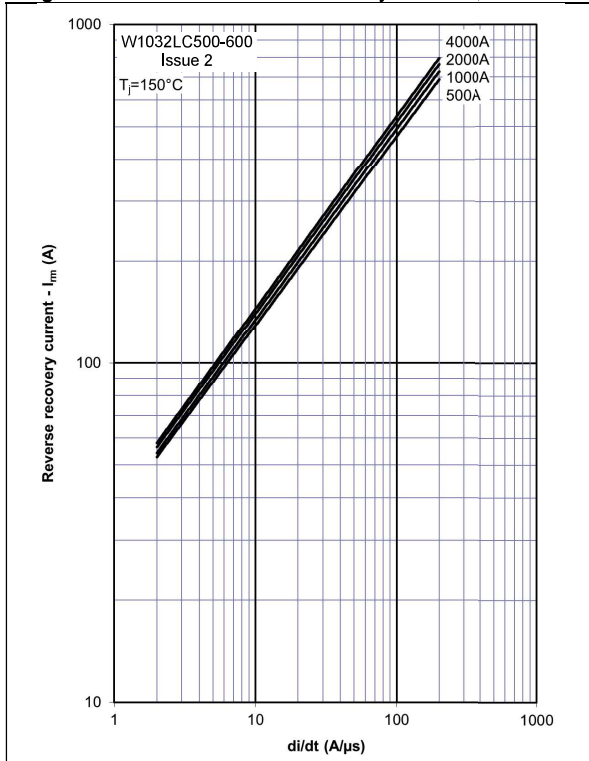

Figure 7 – Reverse recovery time,  $t_{rr}$  (50% chord)

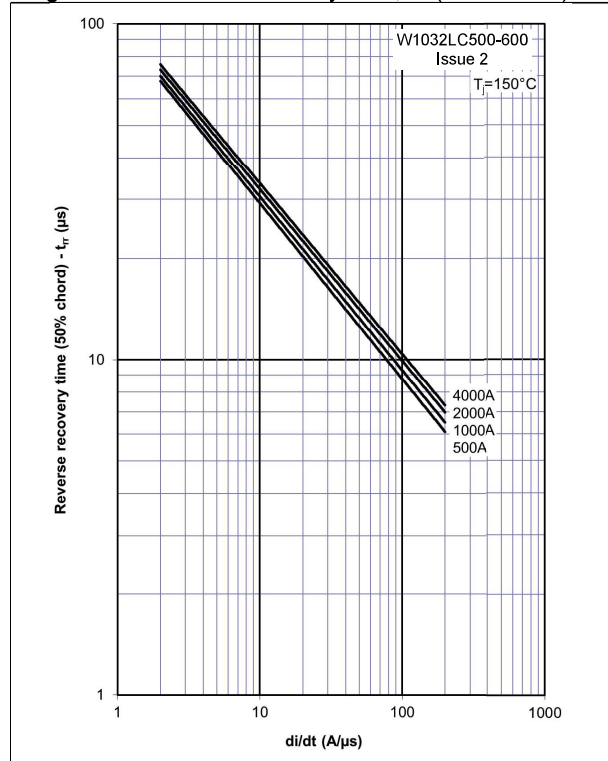

Figure 8 – Forward current vs. Power dissipation – Double Side Cooled

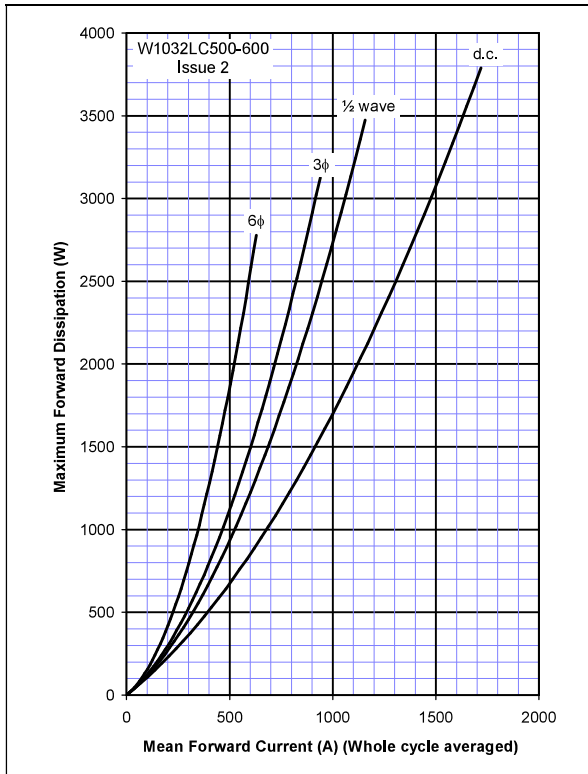

Figure 9 – Forward current vs. Heatsink temperature - Double Side Cooled

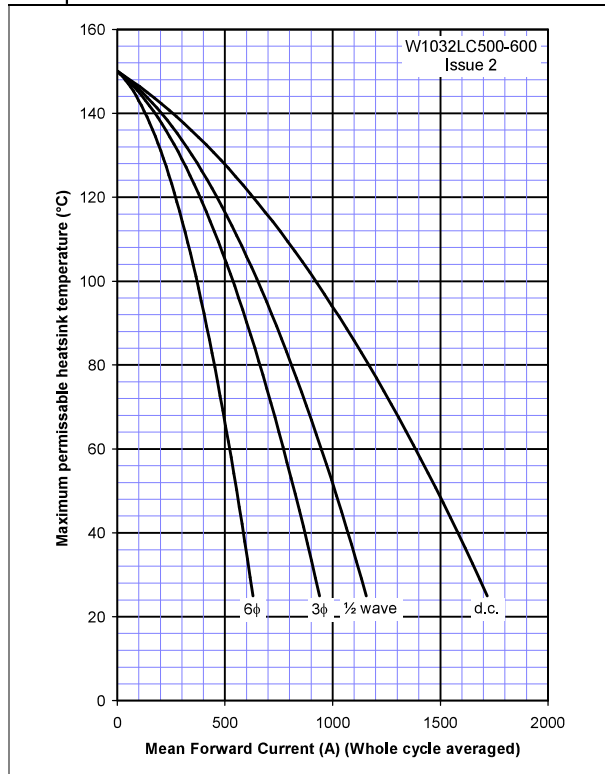

Figure 10 – Forward current vs. Power dissipation – Single Side Cooled

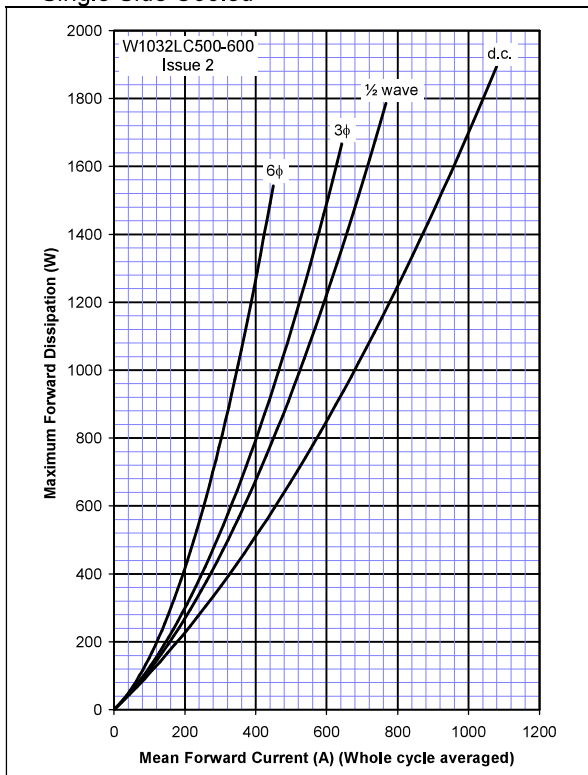
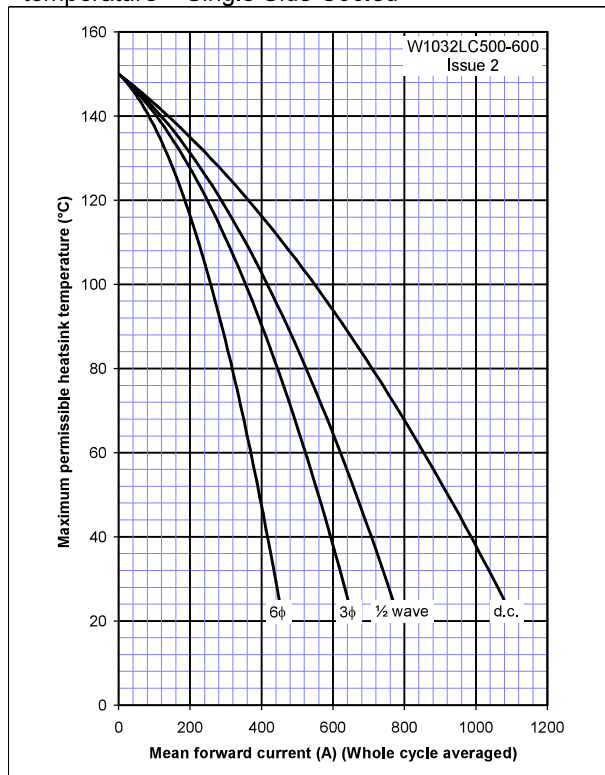
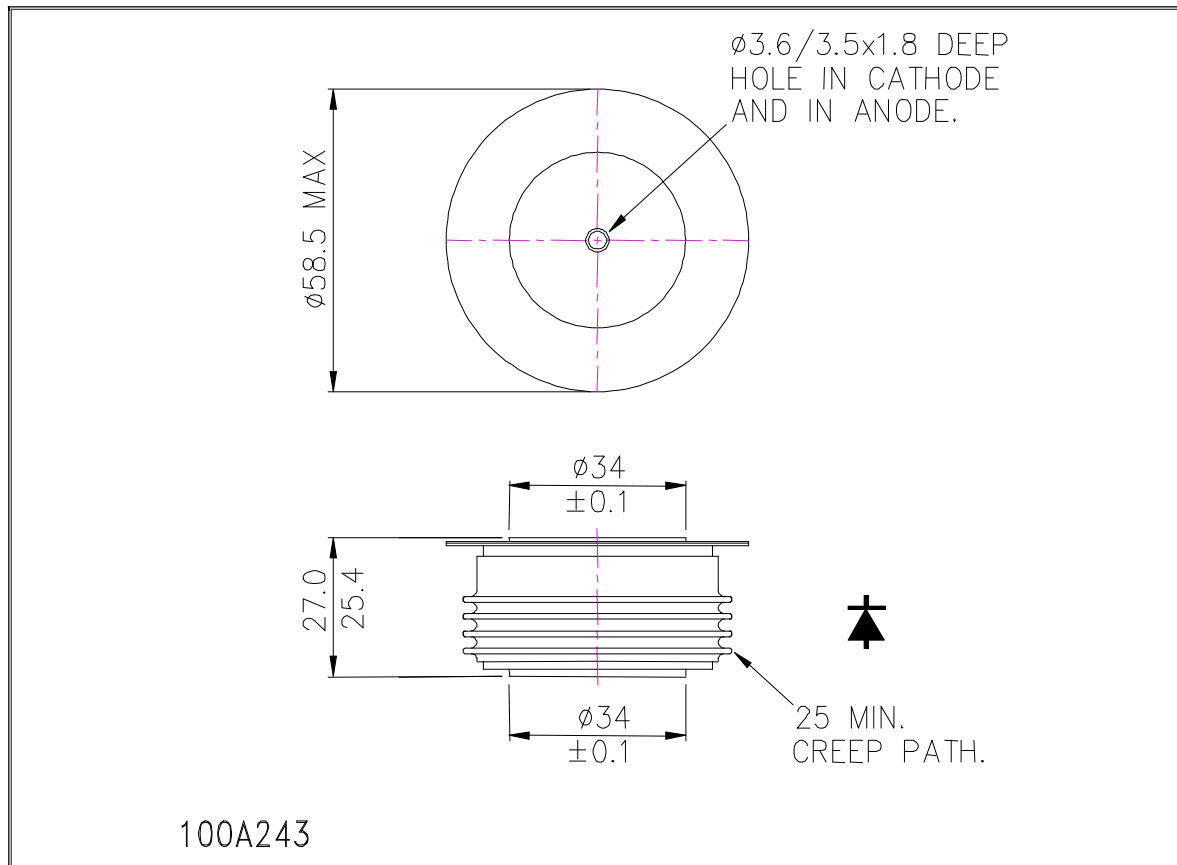

Figure 11 – Forward current vs. Heatsink temperature – Single Side Cooled





**Outline Drawing & Ordering Information**

**ORDERING INFORMATION** (Please quote 10 digit code as below)

|                 |                    |  |                          |
|-----------------|--------------------|--|--------------------------|
| <b>W1032</b>    | <b>LC</b>          | <b>◆◆</b>                              | <b>0</b>                 |
| Fixed Type Code | Fixed Outline Code | Voltage code<br>$V_{DRM}/100$<br>50-60 | Fixed turn-off time code |

 Order code: W1032LC580 – 5800V  $V_{RRM}$ , 27mm clamp height capsule

IXYS UK Westcode Ltd  
 Langley Park Way,  
 Langley Park,  
 Chippenham,  
 Wiltshire, SN15 1GE.  
 Tel: +44 (0)1249 444524  
 E-mail:  
<https://www.littelfuse.com/contactus.aspx>



**IXYS Long Beach**  
 IXYS Long Beach, Inc  
 2500 Mira Mar Ave, Long Beach  
 CA 90815  
 Tel: +1 (562) 296 6584  
 Fax: +1 (562) 296 6585  
 E-mail:  
[powerstacksus@littelfuse.com](mailto:powerstacksus@littelfuse.com)

[www.littelfuse.com](http://www.littelfuse.com)

<https://www.littelfuse.com/products/power-semiconductors/high-power.aspx>

The information contained herein is confidential and is protected by Copyright. The information may not be used or disclosed except with the written permission of and in the manner permitted by the proprietors IXYS UK Westcode Ltd.

© IXYS UK Westcode Ltd.

In the interest of product improvement, Westcode reserves the right to change specifications at any time without prior notice.

Devices with a suffix code (2-letter, 3-letter or letter/digit/letter combination) added to their generic code are not necessarily subject to the conditions and limits contained in this report.



Disclaimer Notice - Information furnished is believed to be accurate and reliable. However, users should independently evaluate the suitability of and test each product selected for their own applications. Littelfuse products are not designed for, and may not be used in, all applications. Read complete Disclaimer Notice at [www.littelfuse.com/disclaimer-electronics](http://www.littelfuse.com/disclaimer-electronics).