



Rectifier Diode

Types W1032LC500 to W1032LC600

(Old Part Number: SW50-60CXC350)

Absolute Maximum Ratings

| | VOLTAGE RATINGS | MAXIMUM LIMITS | UNITS |
|------------------|---|----------------|-------|
| V _{RRM} | Repetitive peak reverse voltage, (note 1) | 5000-6000 | V |
| V _{RSM} | Non-repetitive peak reverse voltage, (note 1) | 5100-6100 | V |

| | OTHER RATINGS | MAXIMUM LIMITS | UNITS |
|----------------------|--|---------------------|------------------|
| I _{F(AV)M} | Maximum average forward current, T _{sink} =55°C, (note 2) | 1032 | A |
| I _{F(AV)M} | Maximum average forward current, T _{sink} =100°C, (note 2) | 689 | A |
| I _{F(AV)M} | Nominal RMS forward current, T _{sink} =100°C, (note 3) | 432 | A |
| I _{F(RMS)M} | Nominal RMS forward current, T _{sink} =25°C, (note 2) | 1912 | A |
| I _{F(d.c.)} | D.C. forward current, T _{sink} =25°C, (note 4) | 1717 | A |
| I _{FSM} | Peak non-repetitive surge t _p =10ms, V _{rm} =0.6V _{RRM} , (note 5) | 7200 | A |
| I _{FSM2} | Peak non-repetitive surge t _p =10ms, V _{rm} ≤10V, (note 5) | 8000 | A |
| I ² t | I ² t capacity for fusing t _p =10ms, V _{rm} =0.6V _{RRM} , (note 5) | 259×10 ³ | A ² s |
| I ² t | I ² t capacity for fusing t _p =10ms, V _{rm} ≤10V, (note 5) | 320×10 ³ | A ² s |
| T _{j op} | Operating temperature range | -40 to +150 | °C |
| T _{stg} | Storage temperature range | -55 to +150 | °C |

Notes:-

- 1) De-rating factor of 0.13% per °C is applicable for T_j below 25°C.
- 2) Double side cooled, single phase; 50Hz, 180° half-sinewave.
- 3) Single side cooled, single phase; 50Hz, 180° half-sinewave.
- 4) Double side cooled.
- 5) Half-sinewave, 150°C T_j initial.

Characteristics

| | PARAMETER | MIN. | TYP. | MAX. | TEST CONDITIONS (Note 1) | UNITS |
|------------|--|------|------|-------|--|------------|
| V_{FM} | Maximum peak forward voltage | - | - | 2.7 | $I_{TM}=2420A$ | V |
| V_{T0} | Threshold voltage | - | - | 1.0 | | V |
| r_T | Slope resistance | - | - | 0.702 | | m Ω |
| I_{RRM} | Peak reverse current | - | - | 30 | Rated V_{RRM} | mA |
| I_{RRM} | Peak reverse current | - | - | 30 | Rated V_{RRM} , $T_j=25^\circ C$ | mA |
| Q_{rr} | Total recovered charge | - | 4400 | - | $I_{FM}=1000A$, $t_p=1ms$, $di/dt=10A/\mu s$, $V_r=50V$ | μC |
| Q_{ra} | Reverse recovery charge (50% chord) | - | 1900 | 2050 | | μC |
| I_{rm} | Reverse recovery current | - | 125 | - | | A |
| t_{rr} | Reverse recovery time (50% chord) | - | 30 | - | | μs |
| R_{thJK} | Thermal resistance, junction to heatsink | - | - | 0.033 | Double side cooled | K/W |
| | | - | - | 0.066 | Single side cooled | K/W |
| F | Mounting force | 10 | - | 20 | | kN |
| W_t | Weight | - | 340 | - | | g |

Notes:-

1) Unless otherwise indicated $T_j=150^\circ C$.

Notes on Ratings and Characteristics

1.0 Voltage Grade Table

| Voltage Grade | V _{RRM} V | V _{RSM} V | V _R DC V |
|---------------|-----------------------|-----------------------|------------------------|
| 50 | 5000 | 5100 | 2200 |
| 52 | 5200 | 5300 | 2240 |
| 54 | 5400 | 5500 | 2280 |
| 56 | 5600 | 5700 | 2320 |
| 58 | 5800 | 5900 | 2360 |
| 60 | 6000 | 6100 | 2400 |

2.0 De-rating Factor

A blocking voltage de-rating factor of 0.13%/°C is applicable to this device for T_j below 25°C.

3.0 Snubber Components

When selecting snubber components, care must be taken not to use excessively large values of snubber capacitor or excessively small values of snubber resistor. Such excessive component values may lead to device damage due to the large resultant values of snubber discharge current. If required, please consult the factory for assistance.

4.0 Computer Modelling Parameters

4.1 Device Dissipation Calculations

$$I_{AV} = \frac{-V_0 + \sqrt{V_0^2 + 4 \cdot ff^2 \cdot r_s \cdot W_{AV}}}{2 \cdot ff^2 \cdot r_s} \quad \text{and:} \quad W_{AV} = \frac{\Delta T}{R_{th}}$$

$$\Delta T = T_{j \max} - T_{Hs}$$

Where V₀=1.0V, r_s=0.702mΩ,

R_{th} = Supplementary thermal impedance, see table below.

ff = Form factor, see table below.

| Supplementary Thermal Impedance (at 50Hz operating frequency) | | | | |
|---|---------------|----------------|------------------|-------|
| Conduction Angle | 6 phase (60°) | 3 phase (120°) | Half wave (180°) | d.c. |
| Square wave Double Side Cooled | 0.045 | 0.040 | 0.036 | 0.033 |
| Square wave Single Side Cooled | 0.081 | 0.075 | 0.070 | 0.066 |
| Sine wave Double Side Cooled | 0.042 | 0.038 | 0.034 | |
| Sine wave Single Side Cooled | 0.079 | 0.072 | 0.067 | |

| Form Factors | | | | |
|------------------|---------------|----------------|------------------|------|
| Conduction Angle | 6 phase (60°) | 3 phase (120°) | Half wave (180°) | d.c. |
| Square wave | 2.45 | 1.73 | 1.41 | 1 |
| Sine wave | 2.78 | 1.88 | 1.57 | |

4.2 Calculating V_F using ABCD Coefficients

The forward characteristic I_F vs. V_F , on page 5 is represented in two ways;

- (i) the well established V_{T0} and r_T tangent used for rating purposes and
- (ii) a set of constants A, B, C, D, forming the coefficients of the representative equation for V_F in terms of I_F given below:

$$V_F = A + B \cdot \ln(I_F) + C \cdot I_F + D \cdot \sqrt{I_F}$$

The constants, derived by curve fitting software, are given below for both hot and cold characteristics. The resulting values for V_F agree with the true device characteristic over a current range, which is limited to that plotted.

| 25°C Coefficients | | 150°C Coefficients | |
|-------------------|----------------------------|--------------------|----------------------------|
| A | 0.786727 | A | 0.5103767 |
| B | 0.06700378 | B | 0.1000737 |
| C | 5.405371×10^{-4} | C | 7.364539×10^{-4} |
| D | -5.209484×10^{-3} | D | -7.568512×10^{-3} |

4.3 D.C. Thermal Impedance Calculation

$$r_t = \sum_{p=1}^{p=n} r_p \cdot \left(1 - e^{\frac{-t}{\tau_p}} \right)$$

Where $p = 1$ to n , n is the number of terms in the series and:

t = Duration of heating pulse in seconds.

r_t = Thermal resistance at time t .

r_p = Amplitude of p th term.

τ_p = Time Constant of r th term.

| D.C. Double Side Cooled | | | | |
|-------------------------|------------|---------------------------|---------------------------|---------------------------|
| Term | 1 | 2 | 3 | 4 |
| r_p | 0.01771901 | 4.240625×10^{-3} | 6.963806×10^{-3} | 3.043661×10^{-3} |
| τ_p | 0.7085781 | 0.1435833 | 0.03615196 | 2.130842×10^{-3} |

| D.C. Single Side Cooled | | | | | |
|-------------------------|------------|---------------------------|---------------------------|--------------------------|---------------------------|
| Term | 1 | 2 | 3 | 4 | 5 |
| r_p | 0.04013371 | 8.832199×10^{-3} | 9.210899×10^{-3} | 3.73647×10^{-3} | 2.594797×10^{-3} |
| τ_p | 4.073105 | 1.196877 | 0.09882439 | 0.01585017 | 2.077263×10^{-3} |

5.0 Reverse recovery ratings

(i) Q_{rr} is based on 50% I_{RM} chord as shown in Fig. 1

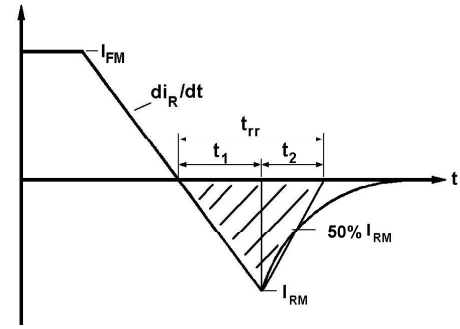

Fig. 1

(ii) Q_{rr} is based on a $150\mu s$ integration time i.e.

$$Q_{rr} = \int_0^{150\mu s} i_{rr} \cdot dt$$

(ii) $K \text{ Factor} = \frac{t_1}{t_2}$

Curves

Figure 1 – Forward characteristics of Limit device

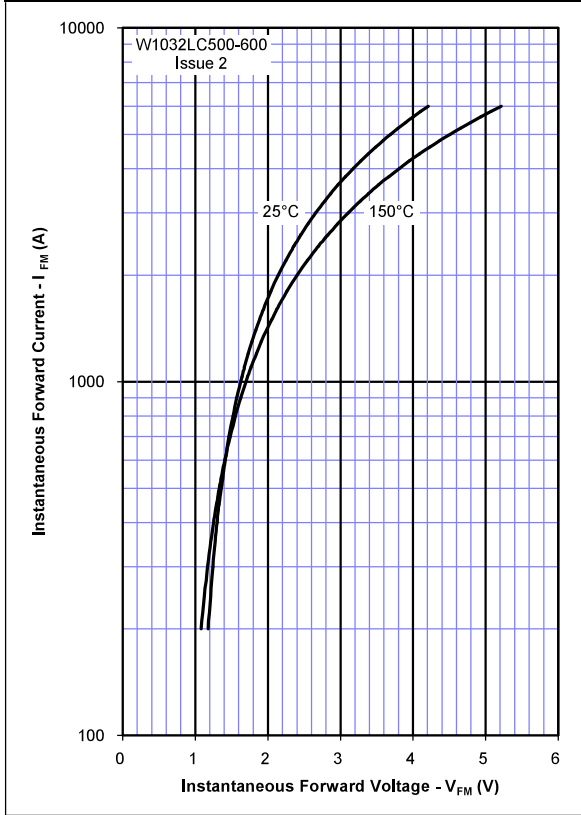

Figure 2 – Transient Thermal Impedance

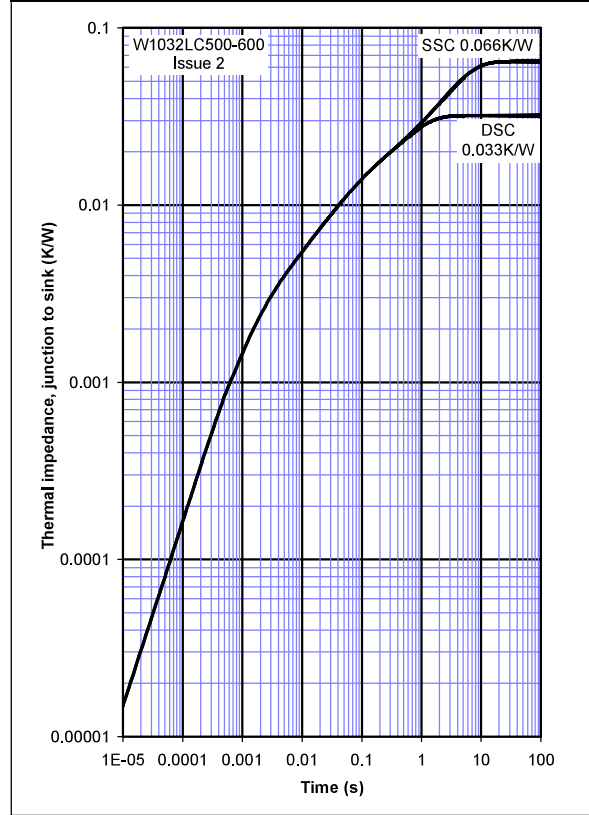

Figure 3 – Maximum surge and I²t Ratings

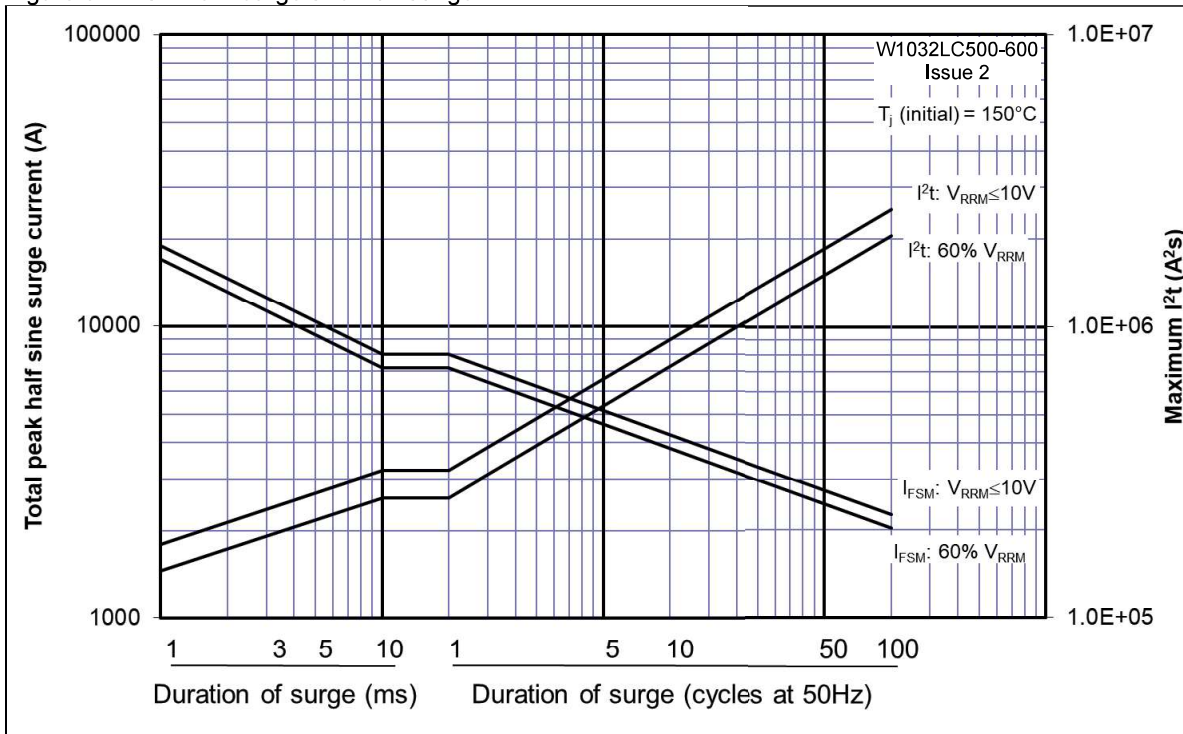

Figure 4 – Total recovered charge, Q_{rr}

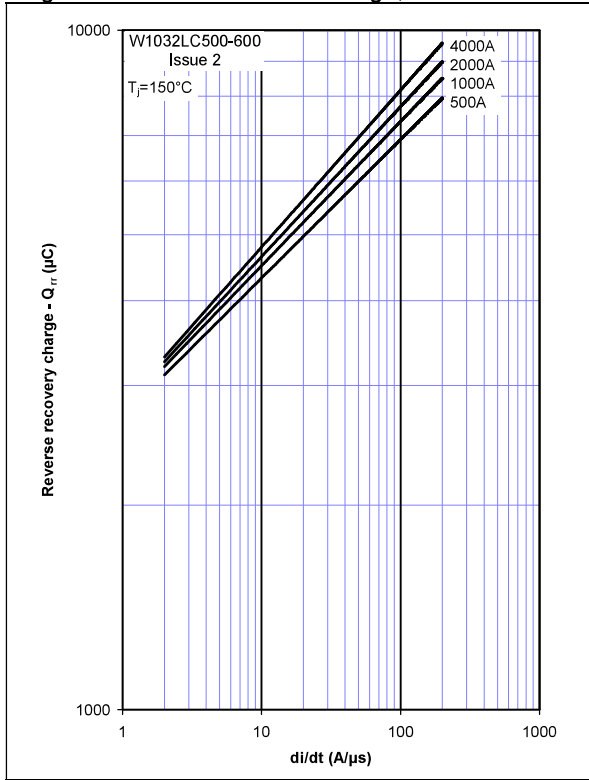

Figure 5 – Recovered charge, Q_{ra} (50% chord)

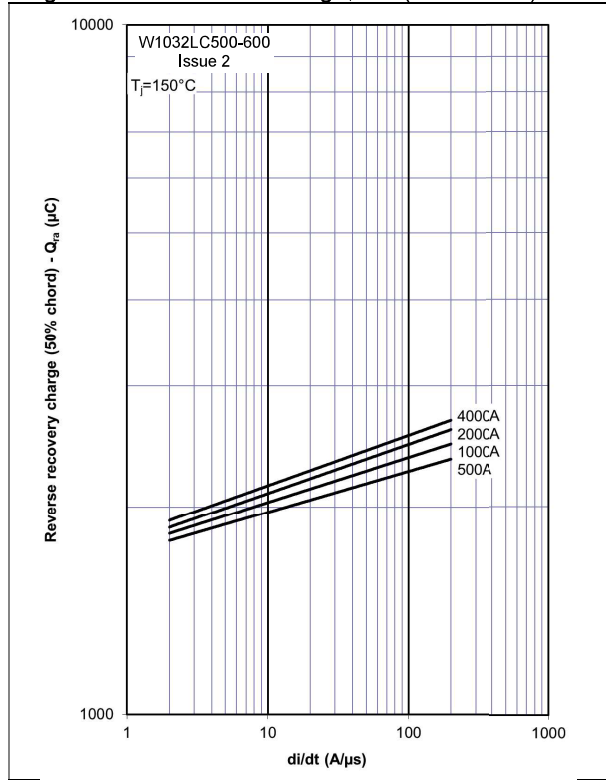

Figure 6 – Peak reverse recovery current, I_{rm}

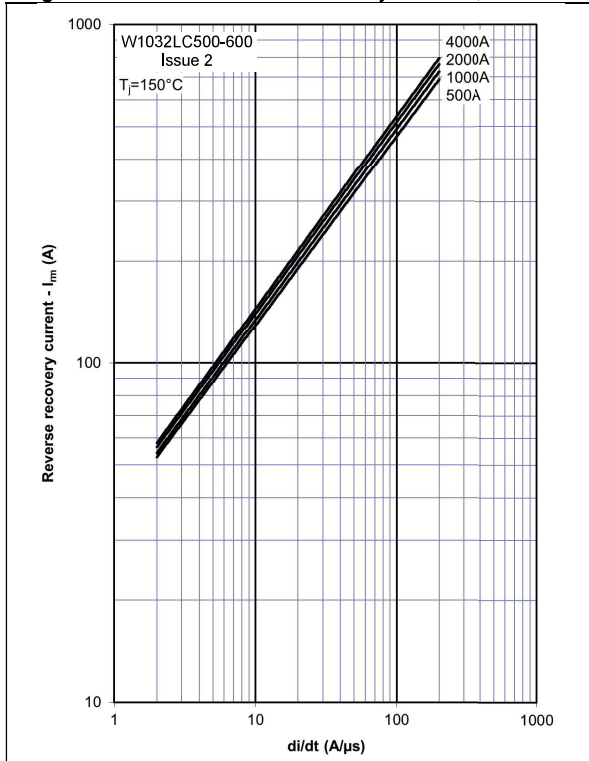

Figure 7 – Reverse recovery time, t_{rr} (50% chord)

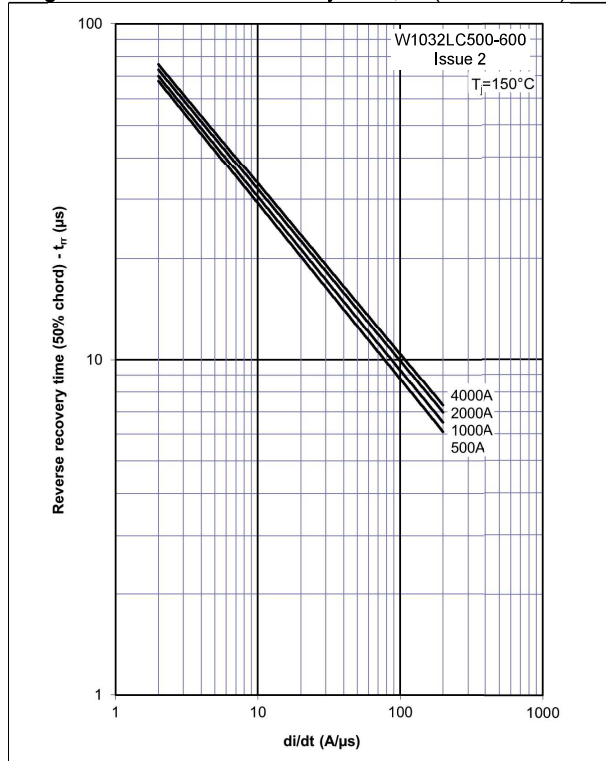

Figure 8 – Forward current vs. Power dissipation – Double Side Cooled

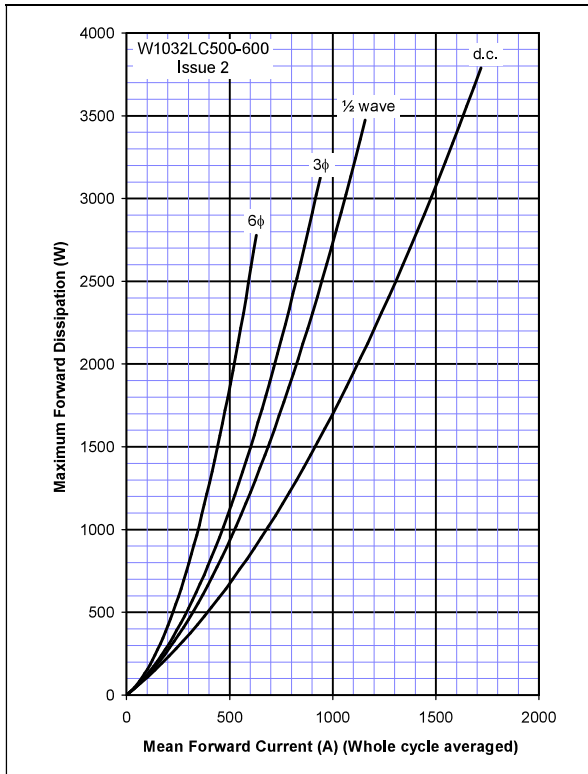

Figure 9 – Forward current vs. Heatsink temperature - Double Side Cooled

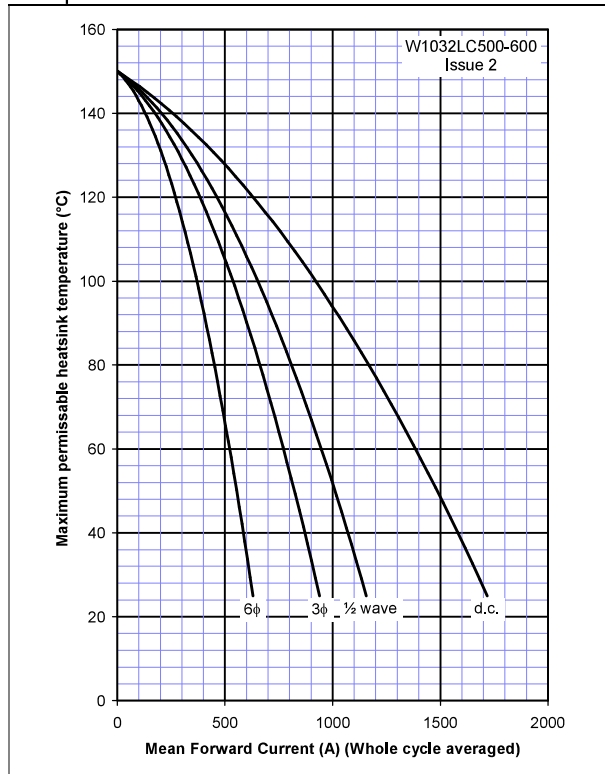

Figure 10 – Forward current vs. Power dissipation – Single Side Cooled

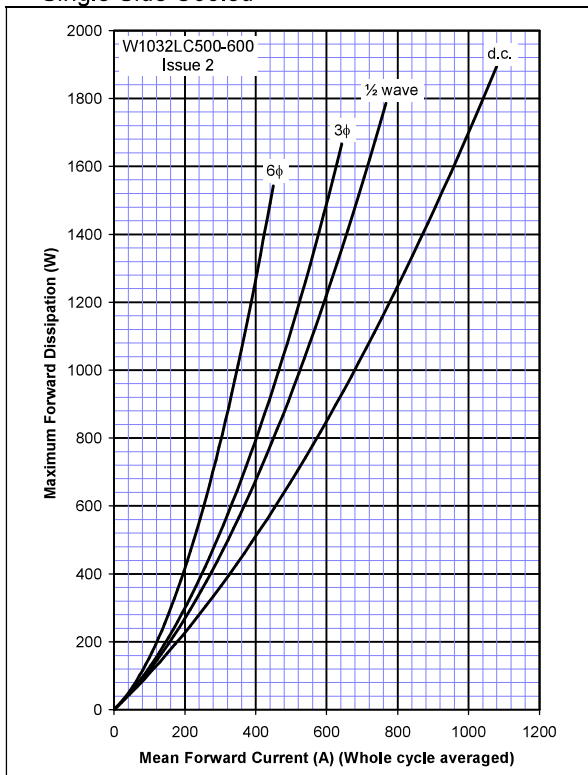
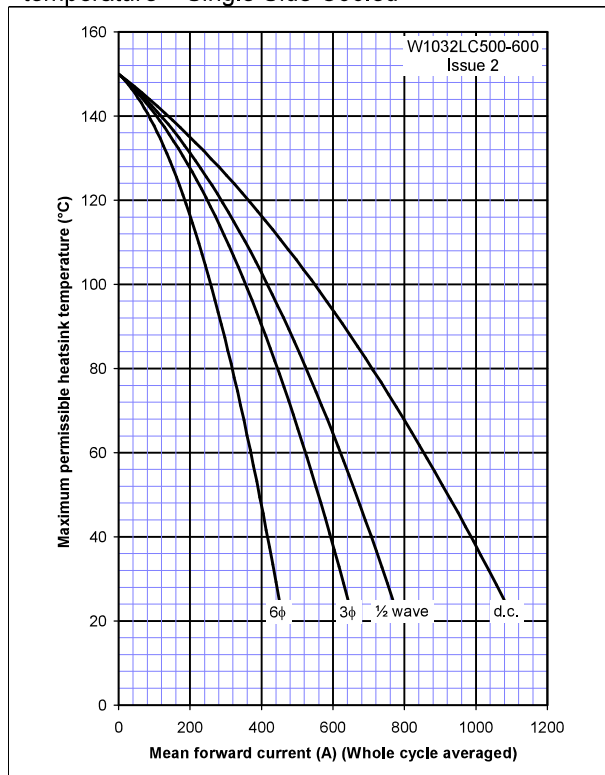
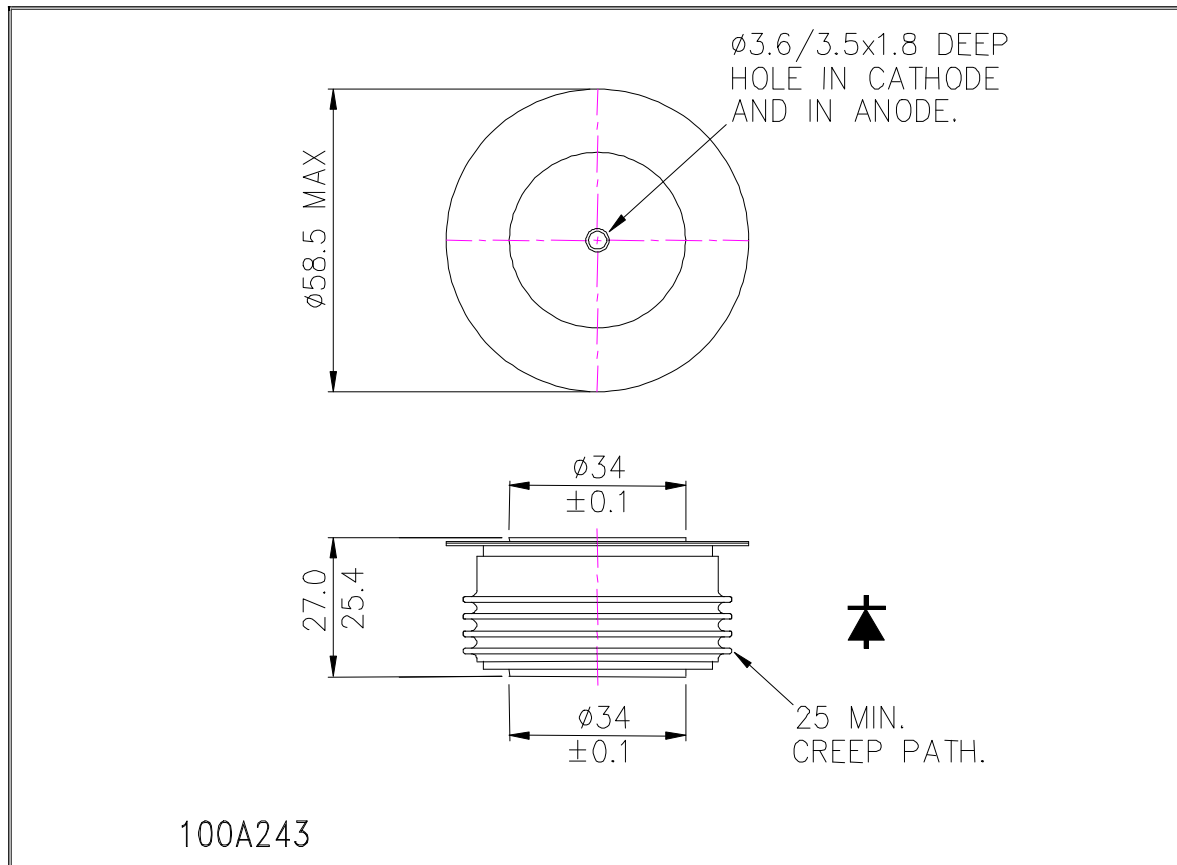

Figure 11 – Forward current vs. Heatsink temperature – Single Side Cooled



Outline Drawing & Ordering Information

ORDERING INFORMATION

(Please quote 10 digit code as below)

| | | | |
|-----------------|--------------------|--|--------------------------|
| W1032 | LC | ◆◆ | 0 |
| Fixed Type Code | Fixed Outline Code | Voltage code $V_{DRM}/100$ 50-60 | Fixed turn-off time code |

 Order code: W1032LC580 – 5800V V_{RRM} , 27mm clamp height capsule

IXYS UK Westcode Ltd
 Langley Park Way,
 Langley Park,
 Chippenham,
 Wiltshire, SN15 1GE.
 Tel: +44 (0)1249 444524
 E-mail:
<https://www.littelfuse.com/contactus.aspx>



IXYS Long Beach
 IXYS Long Beach, Inc
 2500 Mira Mar Ave, Long Beach
 CA 90815
 Tel: +1 (562) 296 6584
 Fax: +1 (562) 296 6585
 E-mail:
powerstacksus@littelfuse.com

www.littelfuse.com

<https://www.littelfuse.com/products/power-semiconductors/high-power.aspx>

The information contained herein is confidential and is protected by Copyright. The information may not be used or disclosed except with the written permission of and in the manner permitted by the proprietors IXYS UK Westcode Ltd.

© IXYS UK Westcode Ltd.

In the interest of product improvement, Westcode reserves the right to change specifications at any time without prior notice.

Devices with a suffix code (2-letter, 3-letter or letter/digit/letter combination) added to their generic code are not necessarily subject to the conditions and limits contained in this report.



Disclaimer Notice - Information furnished is believed to be accurate and reliable. However, users should independently evaluate the suitability of and test each product selected for their own applications. Littelfuse products are not designed for, and may not be used in, all applications. Read complete Disclaimer Notice at www.littelfuse.com/disclaimer-electronics.