

Rectifier Diode

Types W2058LC100 to W2058LC140

Absolute Maximum Ratings

| | VOLTAGE RATINGS | MAXIMUM LIMITS | UNITS |
|-----------|-----------------------------------------------|----------------|-------|
| V_{RRM} | Repetitive peak reverse voltage, (note 1) | 1000-1400 | V |
| V_{RSM} | Non-repetitive peak reverse voltage, (note 1) | 1100-1500 | V |

| | OTHER RATINGS | MAXIMUM LIMITS | UNITS |
|---------------|-------------------------------------------------------------------------|------------------|-------------|
| $I_{F(AV)M}$ | Maximum average forward current, $T_{sink}=55^{\circ}C$, (note 2) | 2058 | A |
| $I_{F(AV)M}$ | Maximum average forward current. $T_{sink}=100^{\circ}C$, (note 2) | 1508 | A |
| $I_{F(AV)M}$ | Maximum average forward current. $T_{sink}=100^{\circ}C$, (note 3) | 924 | A |
| $I_{F(RMS)M}$ | Nominal RMS forward current, $T_{sink}=25^{\circ}C$, (note 2) | 3726 | A |
| $I_{F(d.c.)}$ | D.C. forward current, $T_{sink}=25^{\circ}C$, (note 4) | 3225 | A |
| I_{FSM} | Peak non-repetitive surge $t_p=10ms$, $V_{rm}=60\%V_{RRM}$, (note 5) | 19.5 | kA |
| I_{FSM2} | Peak non-repetitive surge $t_p=10ms$, $V_{rm}\leq 10V$, (note 5) | 21.5 | kA |
| I^2t | I^2t capacity for fusing $t_p=10ms$, $V_{rm}=60\%V_{RRM}$, (note 5) | 1.9×10^6 | A^2s |
| I^2t | I^2t capacity for fusing $t_p=10ms$, $V_{rm}\leq 10V$, (note 5) | 2.3×10^6 | A^2s |
| $T_{j\ op}$ | Operating temperature range | -40 to +175 | $^{\circ}C$ |
| T_{stg} | Storage temperature range | -40 to +200 | $^{\circ}C$ |

Notes:-

- 1) De-rating factor of 0.13% per $^{\circ}C$ is applicable for T_j below $25^{\circ}C$.
- 2) Double side cooled, single phase; 50Hz, 180° half-sinewave.
- 3) Single side cooled, single phase; 50Hz, 180° half-sinewave.
- 4) Double side cooled.
- 5) Half-sinewave, $175^{\circ}C$ T_j initial.

Characteristics

| | PARAMETER | MIN. | TYP. | MAX. | TEST CONDITIONS (Note 1) | UNITS |
|-------------------|------------------------------------------|------|------|-------|-----------------------------------------------------------------------------------|-------|
| V _{FM} | Maximum peak forward voltage | - | - | 1.63 | I _{TM} =4400A | V |
| V _{FM} | Maximum peak forward voltage | - | - | 1.8 | I _{TM} =6175A | V |
| V _{T0} | Threshold voltage | - | - | 0.79 | | V |
| r _T | Slope resistance | - | - | 0.192 | | mΩ |
| I _{RRM} | Peak reverse current | - | - | 30 | Rated V _{RRM} | mA |
| I _{RRM} | Peak reverse current | - | - | 30 | Rated V _{RRM} , T _j =25°C | mA |
| Q _{rr} | Recovered charge | - | 850 | - | I _{TM} =1000A, t _p =1000μs, di/dt=10A/μs, V _r =50V | μC |
| Q _{ra} | Recovered charge, 50% Chord | - | 600 | 850 | | μC |
| I _{rr} | Reverse recovery current | - | 100 | - | | A |
| t _{rr} | Reverse recovery time | - | 12 | - | | μs |
| R _{thJK} | Thermal resistance, junction to heatsink | - | - | 0.033 | Double side cooled | K/W |
| | | - | - | 0.066 | Single side cooled | K/W |
| F | Mounting force | 10 | - | 20 | | kN |
| W _t | Weight | - | 340 | - | | g |

Notes:-

1) Unless otherwise indicated T_j=175°C.

Notes on Ratings and Characteristics

1.0 Voltage Grade Table

| Voltage Grade | V_{DRM} V_{DSM} V_{RRM} V | V_{RSM} V | V_D V_R DC V |
|---------------|------------------------------------|----------------|---------------------|
| 10 | 1000 | 1100 | 700 |
| 12 | 1200 | 1300 | 810 |
| 14 | 1400 | 1500 | 930 |

2.0 Extension of Voltage Grades

This report is applicable to other voltage grades when supply has been agreed by Sales/Production.

3.0 De-rating Factor

A blocking voltage de-rating factor of 0.13%/°C is applicable to this device for T_j below 25°C.

4.0 Snubber Components

When selecting snubber components, care must be taken not to use excessively large values of snubber capacitor or excessively small values of snubber resistor. Such excessive component values may lead to device damage due to the large resultant values of snubber discharge current. If required, please consult the factory for assistance.

5.0 Computer Modelling Parameters

5.1 Device Dissipation Calculations

$$I_{AV} = \frac{-V_{T0} + \sqrt{V_{T0}^2 + 4 \cdot ff^2 \cdot r_T \cdot W_{AV}}}{2 \cdot ff^2 \cdot r_T} \quad \text{and:} \quad W_{AV} = \frac{\Delta T}{R_{th}}$$

$$\Delta T = T_{j \max} - T_K$$

Where $V_{T0}=0.79V$, $r_T=0.192m\Omega$,

R_{th} = Supplementary thermal impedance, see table below and

ff = Form factor, see table below.

| Supplementary Thermal Impedance | | | | |
|---------------------------------|---------------|----------------|---------------|--------|
| Conduction Angle | 6 Phase (60°) | 3 Phase (120°) | ½ Wave (180°) | d.c. |
| Square wave Double Side Cooled | 0.0455 | 0.0393 | 0.0362 | 0.0319 |
| Square wave Single Side Cooled | 0.0753 | 0.0711 | 0.0687 | 0.0646 |
| Sine wave Double Side Cooled | 0.0397 | 0.0350 | 0.0313 | |
| Sine wave Single Side Cooled | 0.0699 | 0.0677 | 0.0653 | |

| Form Factors | | | | |
|------------------|---------------|----------------|---------------|------|
| Conduction Angle | 6 Phase (60°) | 3 Phase (120°) | ½ Wave (180°) | d.c. |
| Square wave | 2.449 | 1.732 | 1.414 | 1 |
| Sine wave | 2.778 | 1.879 | 1.57 | |

5.2 Calculating V_F using ABCD Coefficients

The on-state characteristic I_F vs. V_F , on page 6 is represented in two ways;

- (i) the well established V_{T0} and r_T tangent used for rating purposes and
- (ii) a set of constants A, B, C, D, forming the coefficients of the representative equation for V_F in terms of I_F given below:

$$V_F = A + B \cdot \ln(I_F) + C \cdot I_F + D \cdot \sqrt{I_F}$$

The constants, derived by curve fitting software, are given below for both hot and cold characteristics. The resulting values for V_F agree with the true device characteristic over a current range, which is limited to that plotted.

| | 25°C Coefficients | 175°C Coefficients |
|---|-------------------------|---------------------------|
| A | 1.09345181 | 0.890075253 |
| B | 0.03122052 | 0.02367562 |
| C | 4.872×10^{-5} | 5.14774×10^{-5} |
| D | 1.8884×10^{-3} | 4.745804×10^{-3} |

5.3 D.C. Thermal Impedance Calculation

$$r_t = \sum_{p=1}^{p=n} r_p \cdot \left(1 - e^{-\frac{t}{\tau_p}} \right)$$

Where $p = 1$ to n , n is the number of terms in the series and:

- t = Duration of heating pulse in seconds.
- r_t = Thermal resistance at time t .
- r_p = Amplitude of p^{th} term.
- τ_p = Time Constant of r^{th} term.

The coefficients for this device are shown in the tables below:

| D.C. Single Side Cooled | | | | | |
|-------------------------|---------|-------------------------|----------|-------------------------|--------------------------|
| Term | 1 | 2 | 3 | 4 | 5 |
| r_p | 0.04013 | 6.3388×10^{-3} | 0.011408 | 6.0275×10^{-3} | 7.2098×10^{-4} |
| τ_p | 4.07311 | 2.15774 | 0.19931 | 9.0689×10^{-3} | 4.66345×10^{-4} |

| D.C. Double Side Cooled | | | | |
|-------------------------|----------|-------------------------|-------------------------|--------------------------|
| Term | 1 | 2 | 3 | 4 |
| r_p | 0.017719 | 4.2406×10^{-3} | 6.9638×10^{-3} | 3.04366×10^{-3} |
| τ_p | 0.708578 | 0.1435833 | 0.036152 | 2.1308×10^{-3} |

6.0 Reverse recovery ratings

(i) Q_{ra} is based on 50% I_{RM} chord as shown in Fig. 1



Fig. 1

(ii) Q_{rr} is based on a $150\mu s$ integration time i.e.

$$Q_{rr} = \int_0^{150\mu s} i_{rr} \cdot dt$$

(iii) $K \text{ Factor} = \frac{t_1}{t_2}$

Curves

Figure 1 - Forward characteristics of Limit device

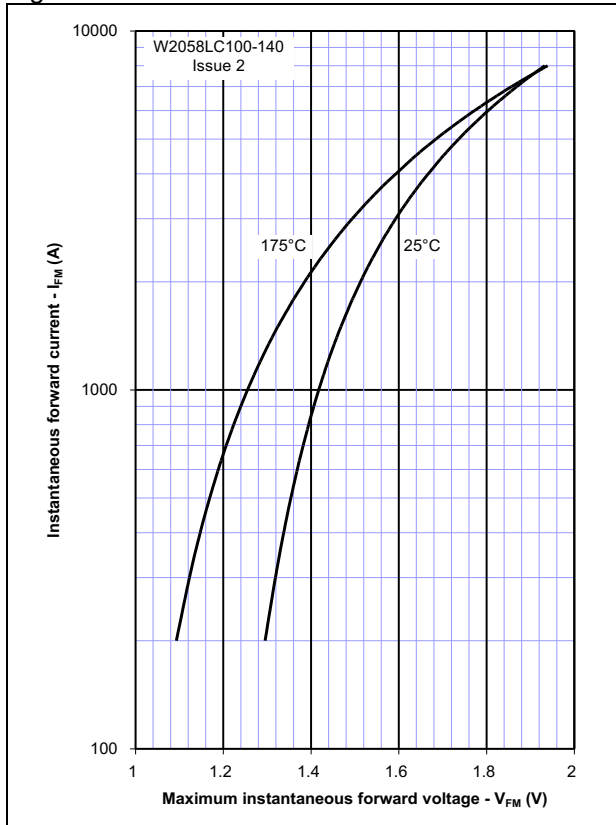

Figure 2 - Transient thermal impedance

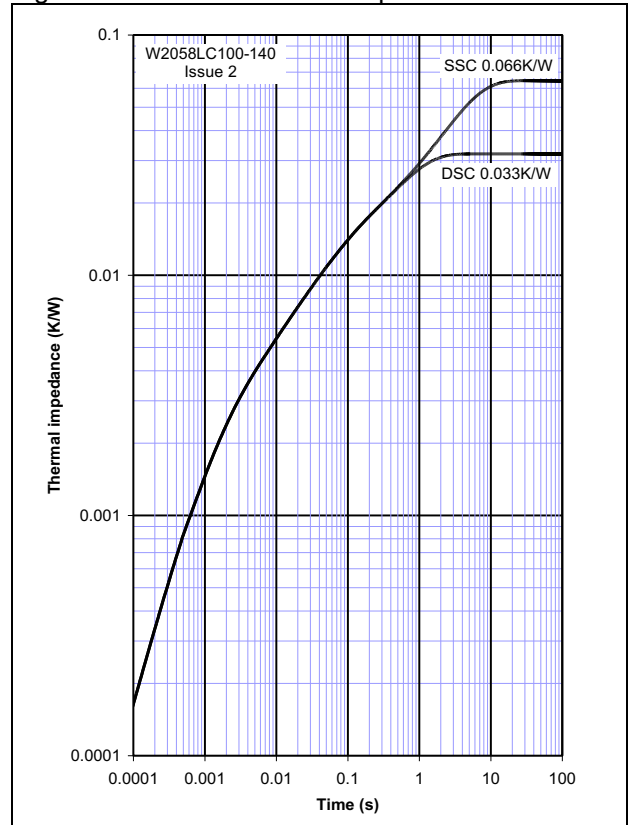

Figure 3 - Maximum surge Rating

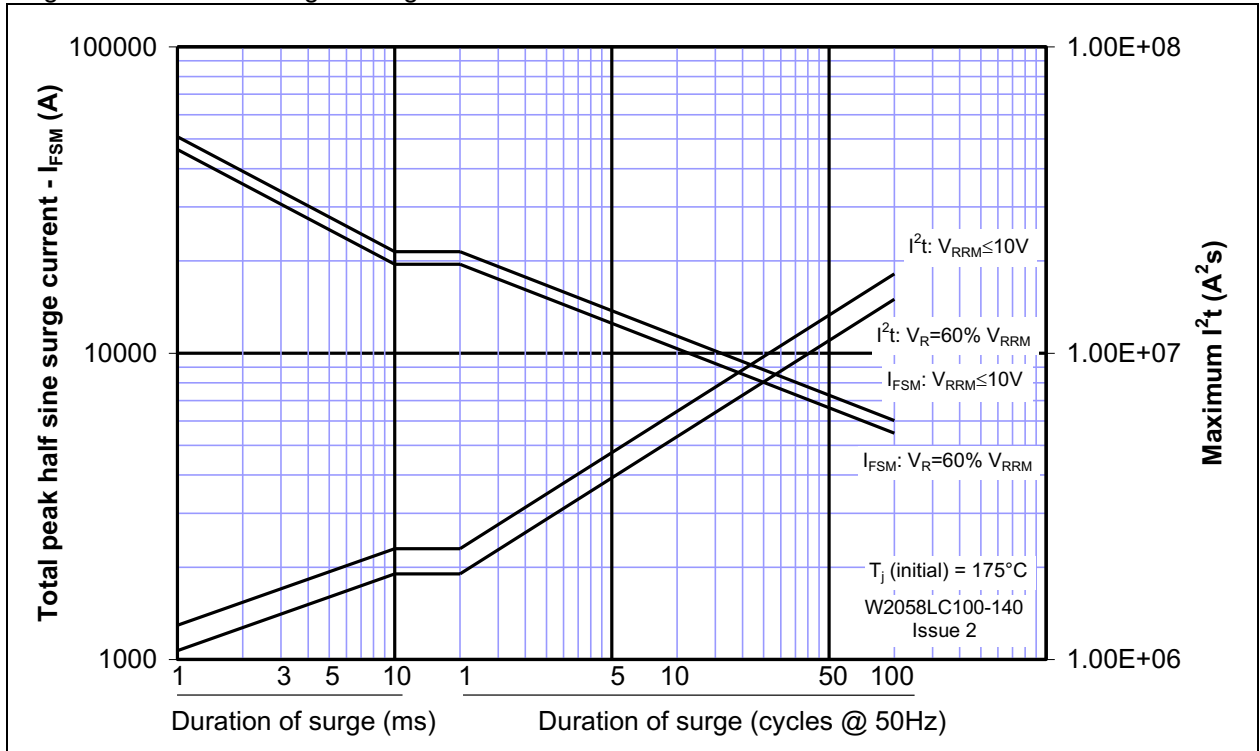

Figure 4 - Total recovered charge, Q_{rr}

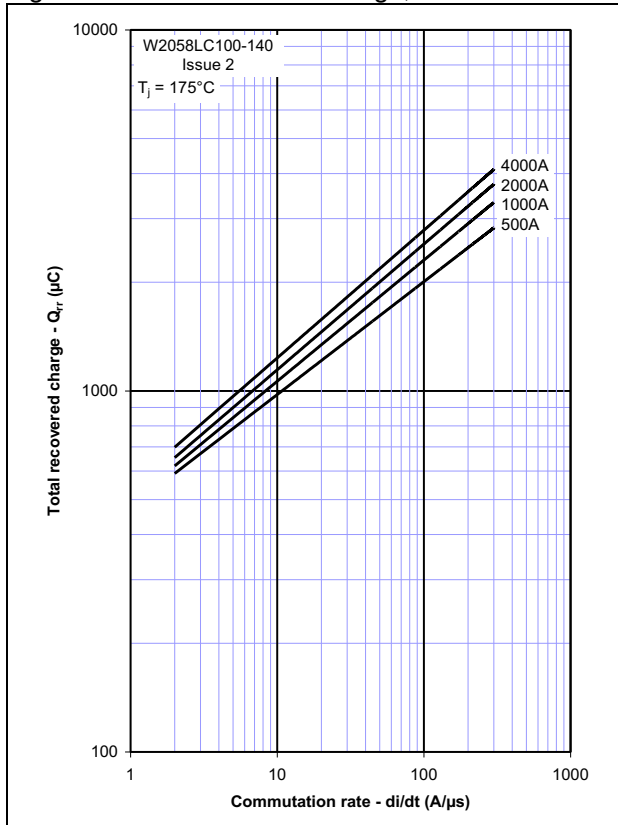

Figure 5 - Recovered charge, Q_{ra} (50% chord)

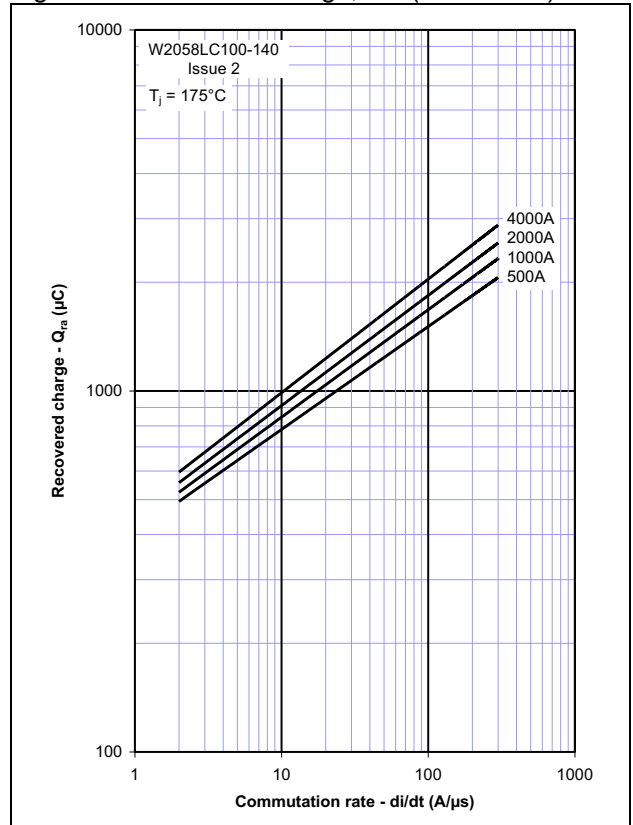

Figure 6 - Peak reverse recovery current, I_{rm}

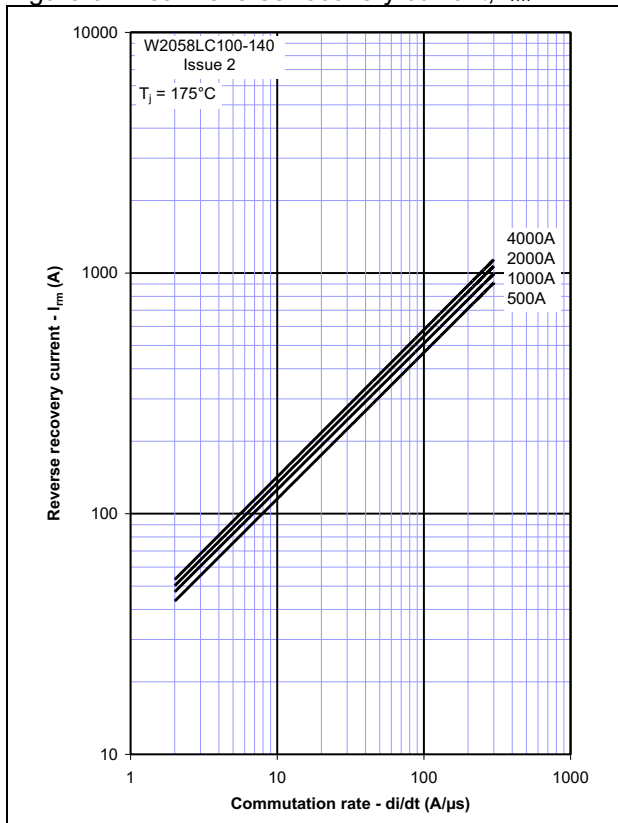

Figure 7 - Maximum recovery time, t_{rr} (50% chord)

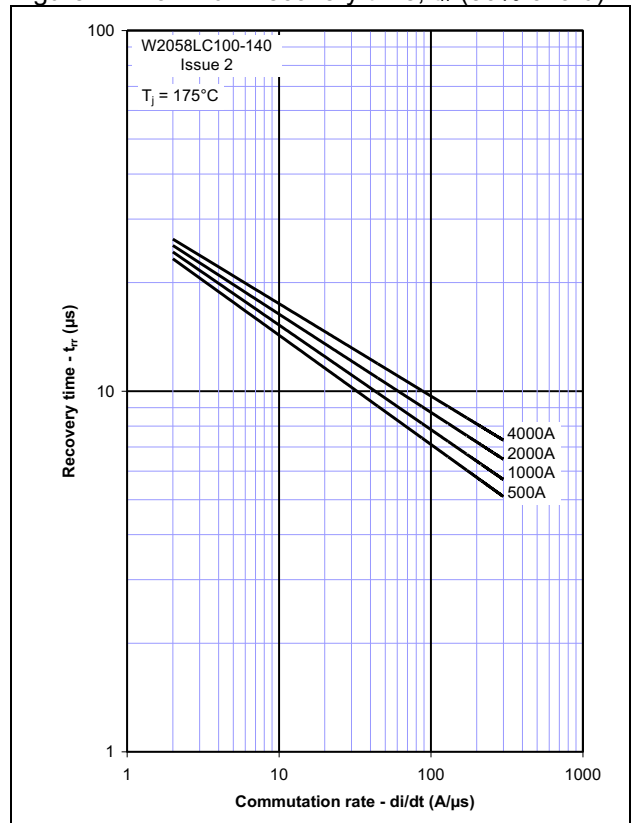

Figure 8 – Forward current vs. Power dissipation – Double Side Cooled

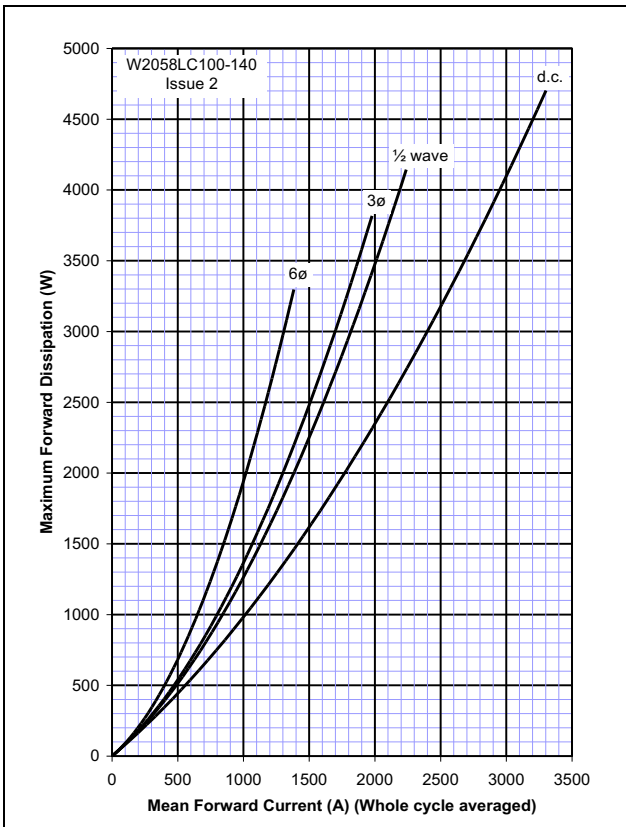

Figure 9 – Forward current vs. Heatsink temperature - Double Side Cooled

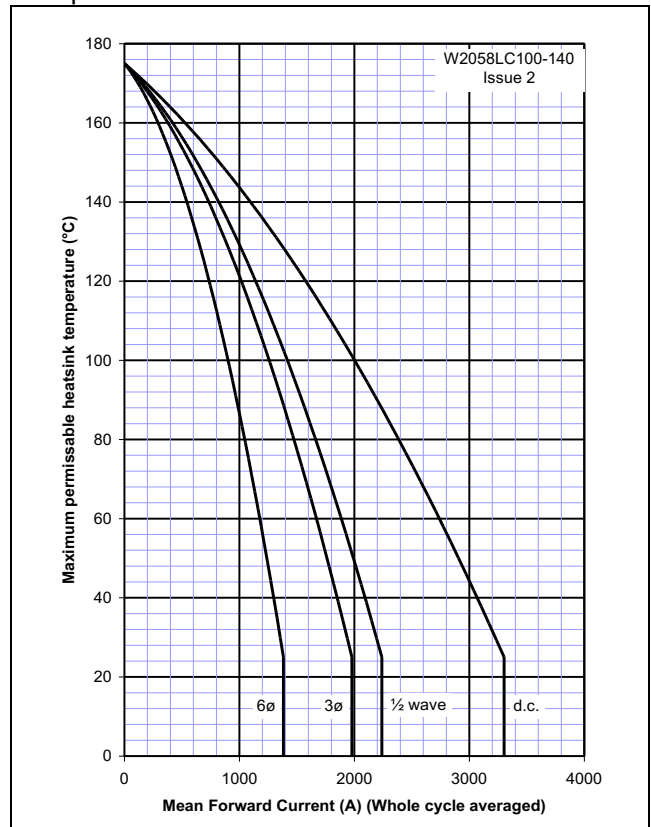

Figure 10 – Forward current vs. Power dissipation – Single Side Cooled

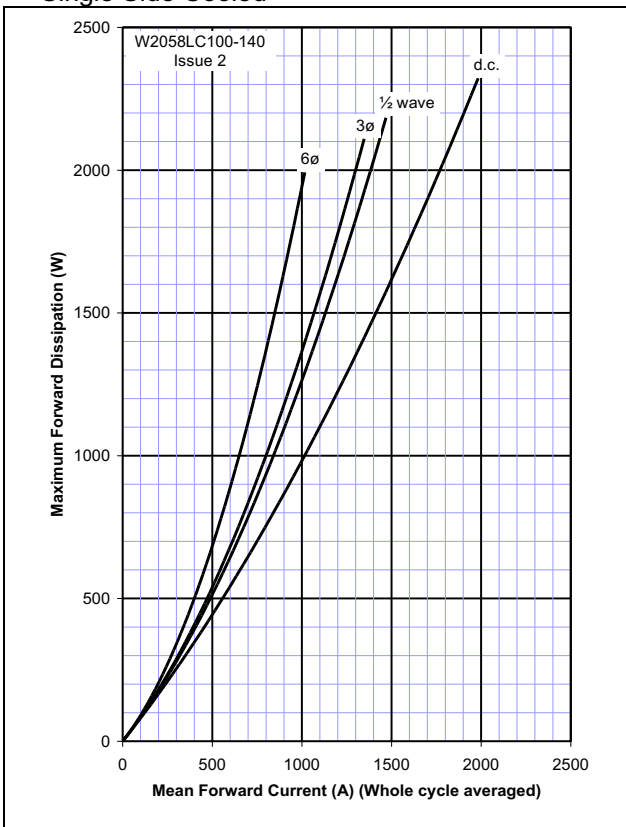
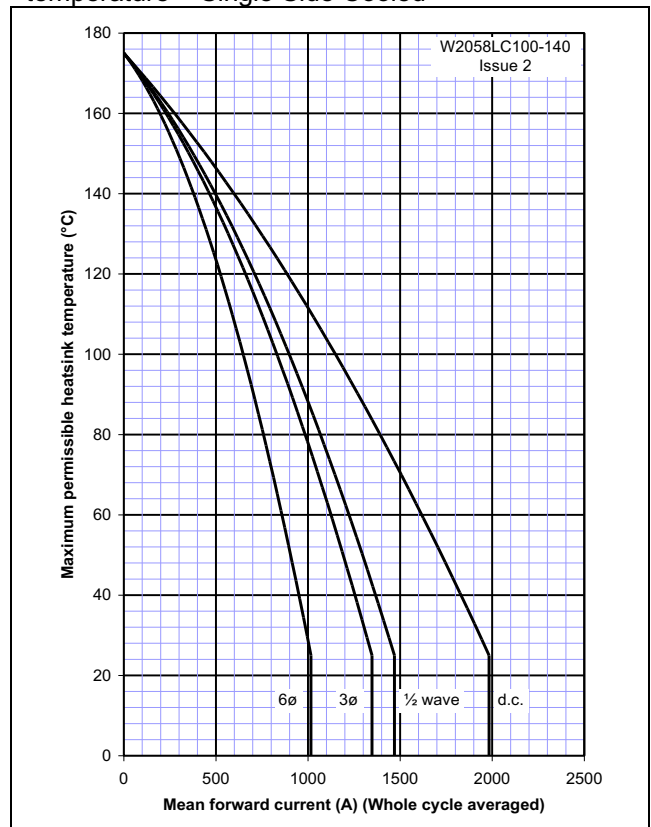
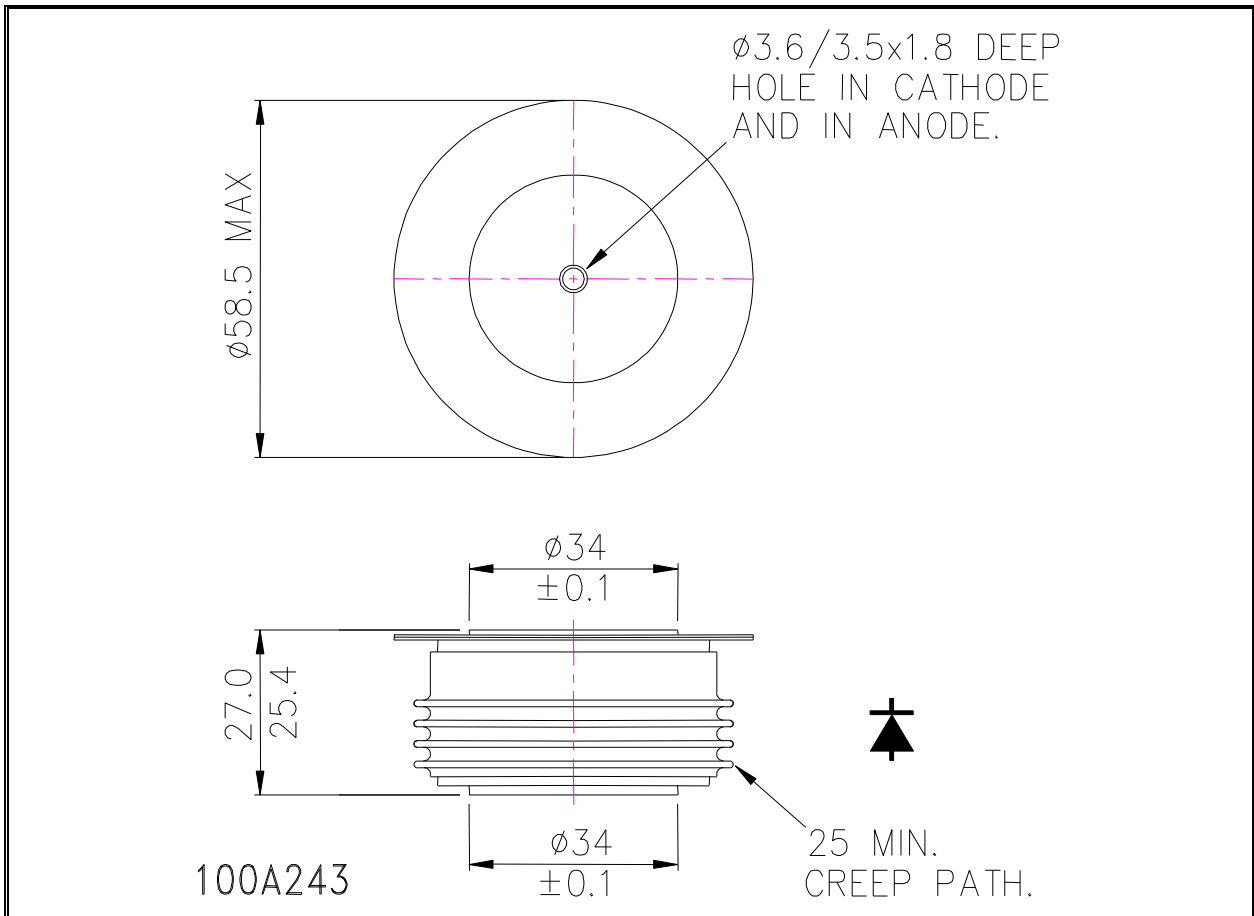

Figure 11 – Forward current vs. Heatsink temperature – Single Side Cooled



Outline Drawing & Ordering Information



100A243

ORDERING INFORMATION

(Please quote 10 digit code as below)

| | | | |
|-----------------|--------------------|----------------------------------------|--------------------------|
| W2058 | LC | ◆◆ | 0 |
| Fixed Type Code | Fixed outline code | Voltage code $V_{DRM}/100$ 10-14 | Fixed turn-off time code |

Order code: W2058LC140 – 1400V V_{DRM} , V_{RRM} , 27mm clamp height capsule.

IXYS Semiconductor GmbH
Edisonstraße 15
D-68623 Lampertheim
Tel: +49 6206 503-0
Fax: +49 6206 503-627
E-mail: marcom@ixys.de



IXYS UK Westcode Ltd
Langley Park Way, Langley Park,
Chippenham, Wiltshire, SN15 1GE.
Tel: +44 (0)1249 444524
Fax: +44 (0)1249 659448
E-mail: sales@ixysuk.com

IXYS Corporation
1590 Buckeye Drive
Milpitas CA 95035-7418
Tel: +1 (408) 457 9000
Fax: +1 (408) 496 0670
E-mail: sales@ixys.net

www.ixysuk.com

www.ixys.com

IXYS Long Beach
IXYS Long Beach, Inc
2500 Mira Mar Ave, Long Beach
CA 90815
Tel: +1 (562) 296 6584
Fax: +1 (562) 296 6585
E-mail: service@ixyslongbeach.com

The information contained herein is confidential and is protected by Copyright. The information may not be used or disclosed except with the written permission of and in the manner permitted by the proprietors IXYS UK Westcode Ltd.

© IXYS UK Westcode Ltd.

In the interest of product improvement, IXYS UK Westcode Ltd reserves the right to change specifications at any time without prior notice.

Devices with a suffix code (2-letter or letter/digit/letter combination) added to their generic code are not necessarily subject to the conditions and limits contained in this report.



Disclaimer Notice - Information furnished is believed to be accurate and reliable. However, users should independently evaluate the suitability of and test each product selected for their own applications. Littelfuse products are not designed for, and may not be used in, all applications. Read complete Disclaimer Notice at www.littelfuse.com/disclaimer-electronics.