

# Rectifier Diode

## Type W2624N#240 to W2624N#280

### Absolute Maximum Ratings

	VOLTAGE RATINGS	MAXIMUM LIMITS	UNITS
$V_{RRM}$	Repetitive peak reverse voltage, (note 1)	2400-2800	V
$V_{RSM}$	Non-repetitive peak reverse voltage, (note 1)	2500-2900	V

	OTHER RATINGS	MAXIMUM LIMITS	UNITS
$I_{F(AV)M}$	Maximum average forward current, $T_{sink}=55^{\circ}C$ , (note 2)	2624	A
$I_{F(AV)M}$	Maximum average forward current. $T_{sink}=85^{\circ}C$ , (note 2)	2110	A
$I_{F(AV)M}$	Maximum average forward current. $T_{sink}=85^{\circ}C$ , (note 3)	1311	A
$I_{F(RMS)M}$	Nominal RMS forward current, $T_{sink}=25^{\circ}C$ , (note 2)	4828	A
$I_{F(d.c.)}$	D.C. forward current, $T_{sink}=25^{\circ}C$ , (note 4)	4218	A
$I_{FSM}$	Peak non-repetitive surge $t_p=10ms$ , $V_{rm}=0.6V_{RRM}$ , (note 5)	28.0	kA
$I_{FSM2}$	Peak non-repetitive surge $t_p=10ms$ , $V_{rm}\leq 10V$ , (note 5)	30.8	kA
$I^2t$	$I^2t$ capacity for fusing $t_p=10ms$ , $V_{rm}=0.6V_{RRM}$ , (note 5)	$3.92\times 10^6$	$A^2s$
$I^2t$	$I^2t$ capacity for fusing $t_p=10ms$ , $V_{rm}\leq 10V$ , (note 5)	$4.74\times 10^6$	$A^2s$
$T_{j\ op}$	Operating temperature range	-55 to +160	$^{\circ}C$
$T_{stg}$	Storage temperature range	-55 to +190	$^{\circ}C$

Notes:-

- 1) De-rating factor of 0.13% per  $^{\circ}C$  is applicable for  $T_j$  below  $25^{\circ}C$ .
- 2) Double side cooled, single phase; 50Hz,  $180^{\circ}$  half-sinewave.
- 3) Single side cooled, single phase; 50Hz,  $180^{\circ}$  half-sinewave.
- 4) Double side cooled.
- 5) Half-sinewave,  $160^{\circ}C$   $T_j$  initial.

### Characteristics

	PARAMETER	MIN.	TYP.	MAX.	TEST CONDITIONS (Note 1)	UNITS
V <sub>FM</sub>	Maximum peak forward voltage	-	-	1.5	I <sub>TM</sub> =4500A	V
V <sub>FM</sub>	Maximum peak forward voltage	-	-	2.03	I <sub>TM</sub> =7870A	V
V <sub>T0</sub>	Threshold voltage	-	-	0.78		V
r <sub>T</sub>	Slope resistance	-	-	0.16		mΩ
I <sub>RRM</sub>	Peak reverse current	-	-	50	Rated V <sub>RRM</sub>	mA
I <sub>RRM</sub>	Peak reverse current	-	-	50	Rated V <sub>RRM</sub> , T <sub>j</sub> =25°C	mA
Q <sub>rr</sub>	Recovered charge	-	3100	-	I <sub>TM</sub> =1000A, t <sub>p</sub> =1000μs, di/dt=10A/μs, V <sub>r</sub> =50V	μC
Q <sub>ra</sub>	Recovered charge, 50% Chord	-	2200	2600		μC
I <sub>rr</sub>	Reverse recovery current	-	160	-		A
t <sub>rr</sub>	Reverse recovery time	-	27	-		μs
R <sub>thJK</sub>	Thermal resistance, junction to heatsink	-	-	0.022	Double side cooled	K/W
		-	-	0.044	Single side cooled	K/W
F	Mounting force	19	-	26		kN
W <sub>t</sub>	Weight	-	510	-	NC housing option	g
W <sub>t</sub>	Weight	-	430	-	ND housing option	g

Notes:-

1) Unless otherwise indicated T<sub>j</sub>=160°C.

## Notes on Ratings and Characteristics

### 1.0 Voltage Grade Table

Voltage Grade	$V_{DRM}$ $V_{DSM}$ $V_{RRM}$ V	$V_{RSM}$ V	$V_D$ $V_R$ DC V
24	2400	2500	1450
28	2800	2900	1680

### 2.0 Extension of Voltage Grades

This report is applicable to other voltage grades when supply has been agreed by Sales/Production.

### 3.0 De-rating Factor

A blocking voltage de-rating factor of 0.13%/°C is applicable to this device for  $T_j$  below 25°C.

### 4.0 Snubber Components

When selecting snubber components, care must be taken not to use excessively large values of snubber capacitor or excessively small values of snubber resistor. Such excessive component values may lead to device damage due to the large resultant values of snubber discharge current. If required, please consult the factory for assistance.

### 5.0 Computer Modelling Parameters

#### 5.1 Device Dissipation Calculations

$$I_{AV} = \frac{-V_0 + \sqrt{V_0^2 + 4 \cdot ff \cdot r_s \cdot W_{AV}}}{2 \cdot ff \cdot r_s} \quad \text{and:} \quad W_{AV} = \frac{\Delta T}{R_{th}}$$

$$\Delta T = T_{j \max} - T_{Hs}$$

Where  $V_0=0.78V$ ,  $r_s=0.16m\Omega$ ,

$R_{th}$  = Supplementary thermal impedance, see table below and

$ff$  = Form factor, see table below.

Supplementary Thermal Impedance							
Conduction Angle	30°	60°	90°	120°	180°	270°	d.c.
Square wave Double Side Cooled	0.0312	0.0285	0.0267	0.0255	0.0240	0.0228	0.0220
Square wave Single Side Cooled	0.0543	0.0513	0.0496	0.0484	0.0469	0.0455	0.0440
Sine wave Double Side Cooled	0.0268	0.0257	0.0241	0.0233	0.022		
Sine wave Single Side Cooled	0.0509	0.0482	0.0471	0.0463	0.044		

Form Factors							
Conduction Angle	30°	60°	90°	120°	180°	270°	d.c.
Square wave	3.464	2.449	2	1.732	1.414	1.149	1
Sine wave	3.98	2.778	2.22	1.879	1.57		

## 5.2 Calculating $V_F$ using ABCD Coefficients

The on-state characteristic  $I_F$  vs.  $V_F$ , on page 6 is represented in two ways;

- (i) the well established  $V_0$  and  $r_s$  tangent used for rating purposes and
- (ii) a set of constants A, B, C, D, forming the coefficients of the representative equation for  $V_F$  in terms of  $I_F$  given below:

$$V_F = A + B \cdot \ln(I_F) + C \cdot I_F + D \cdot \sqrt{I_F}$$

The constants, derived by curve fitting software, are given below for both hot and cold characteristics. The resulting values for  $V_F$  agree with the true device characteristic over a current range, which is limited to that plotted.

	25°C Coefficients	160°C Coefficients
A	0.7560109	0.4728865
B	0.027321	0.05340866
C	$9.716363 \times 10^{-5}$	$1.63729 \times 10^{-4}$
D	$2.581858 \times 10^{-4}$	$-2.329493 \times 10^{-3}$

5.3 D.C. Thermal Impedance Calculation

$$r_t = \sum_{p=1}^{p=n} r_p \cdot \left( 1 - e^{-\frac{t}{\tau_p}} \right)$$

Where  $p = 1$  to  $n$ ,  $n$  is the number of terms in the series and:

- $t$  = Duration of heating pulse in seconds.
- $r_t$  = Thermal resistance at time  $t$ .
- $r_p$  = Amplitude of  $p^{\text{th}}$  term.
- $\tau_p$  = Time Constant of  $r^{\text{th}}$  term.

The coefficients for this device are shown in the tables below:

D.C. Single Side Cooled					
Term	1	2	3	4	5
$r_p$	0.0291698	$4.295845 \times 10^{-3}$	$7.57109 \times 10^{-3}$	$2.195801 \times 10^{-3}$	$1.628753 \times 10^{-3}$
$\tau_p$	5.67822	1.123602	0.1407857	0.014381914	$1.272749 \times 10^{-3}$

D.C. Double Side Cooled				
Term	1	2	3	4
$r_p$	0.01177146	$6.485814 \times 10^{-3}$	$2.471007 \times 10^{-3}$	$1.607109 \times 10^{-3}$
$\tau_p$	0.9495346	0.1337950	0.01636628	$1.255571 \times 10^{-3}$

6.0 Reverse recovery ratings

(i)  $Q_{ra}$  is based on 50%  $I_{RM}$  chord as shown in Fig. 1



Fig. 1

(ii)  $Q_{rr}$  is based on a  $150\mu s$  integration time i.e.

$$Q_{rr} = \int_0^{150\mu s} i_{rr} \cdot dt$$

(iii)  $K \text{ Factor} = \frac{t1}{t2}$

**Curves**

Figure 1 - Forward characteristics of Limit device

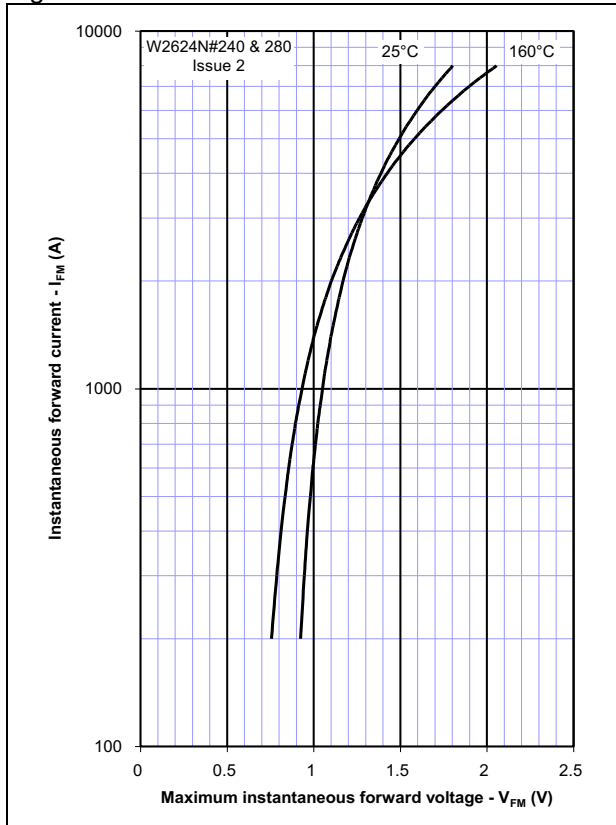

Figure 2 - Transient thermal impedance

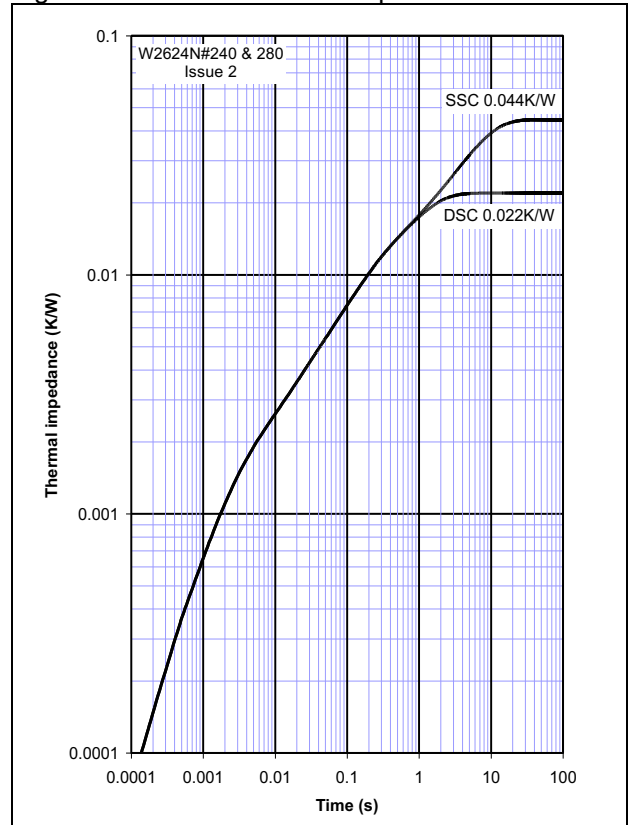

Figure 3 - Maximum surge Rating

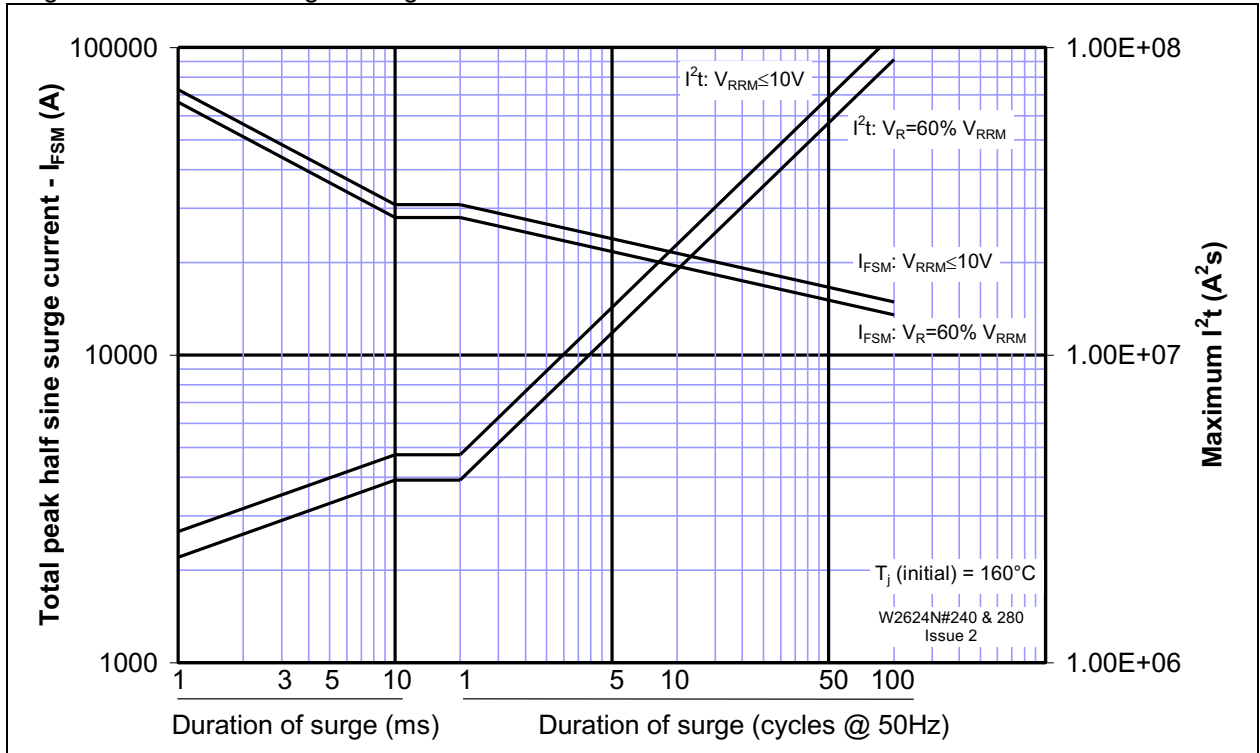

Figure 4 - Total recovered charge,  $Q_{rr}$

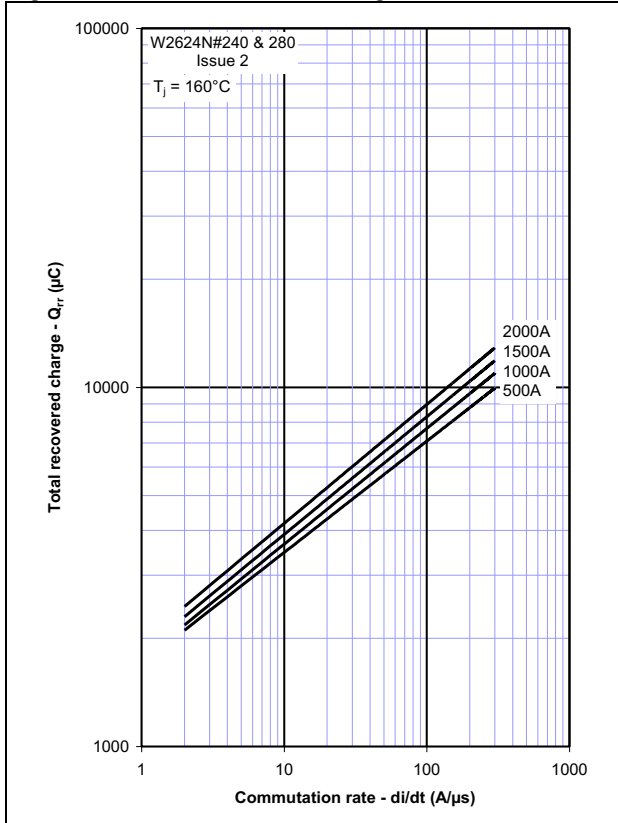

Figure 5 - Recovered charge,  $Q_{ra}$  (50% chord)

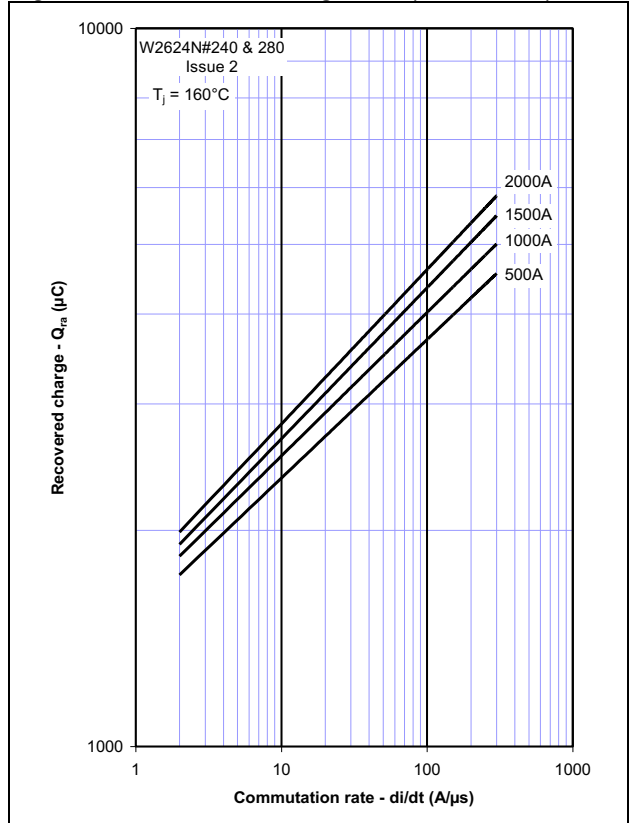

Figure 6 - Peak reverse recovery current,  $I_{rm}$

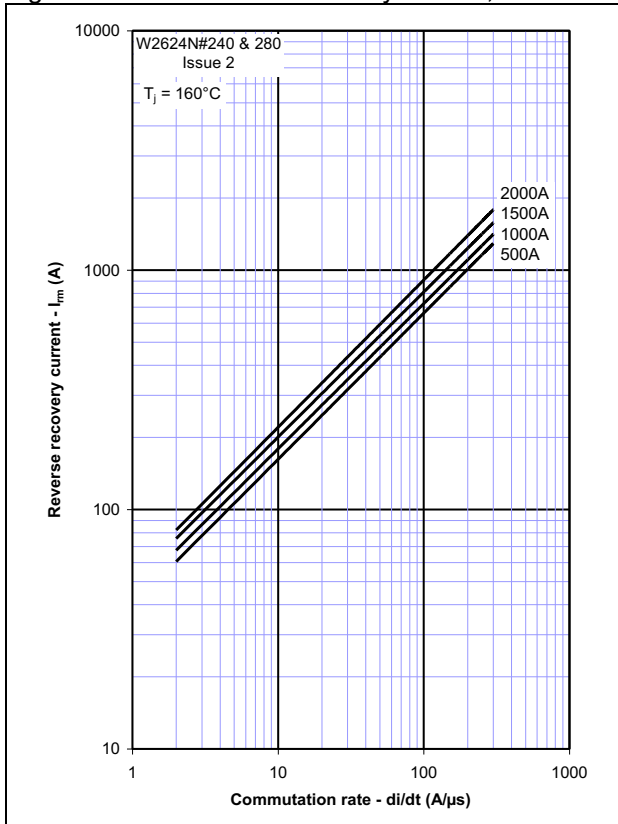

Figure 7 - Maximum recovery time,  $t_{rr}$  (50% chord)

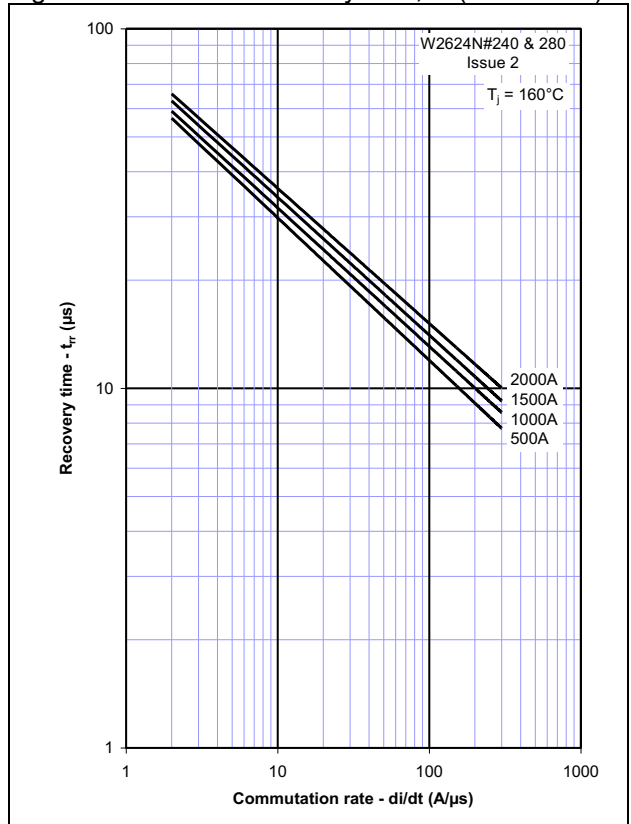

Figure 8 – Forward current vs. Power dissipation – Double Side Cooled

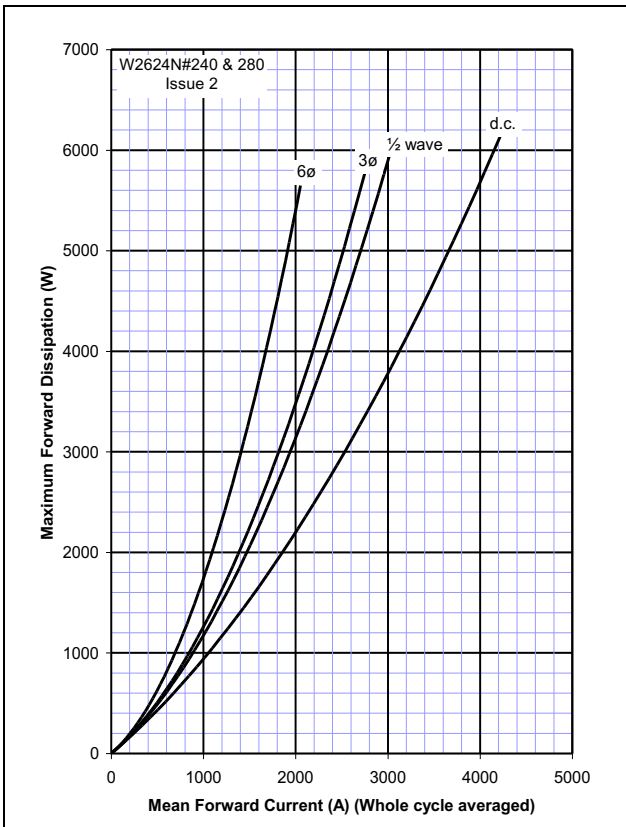

Figure 9 – Forward current vs. Heatsink temperature - Double Side Cooled

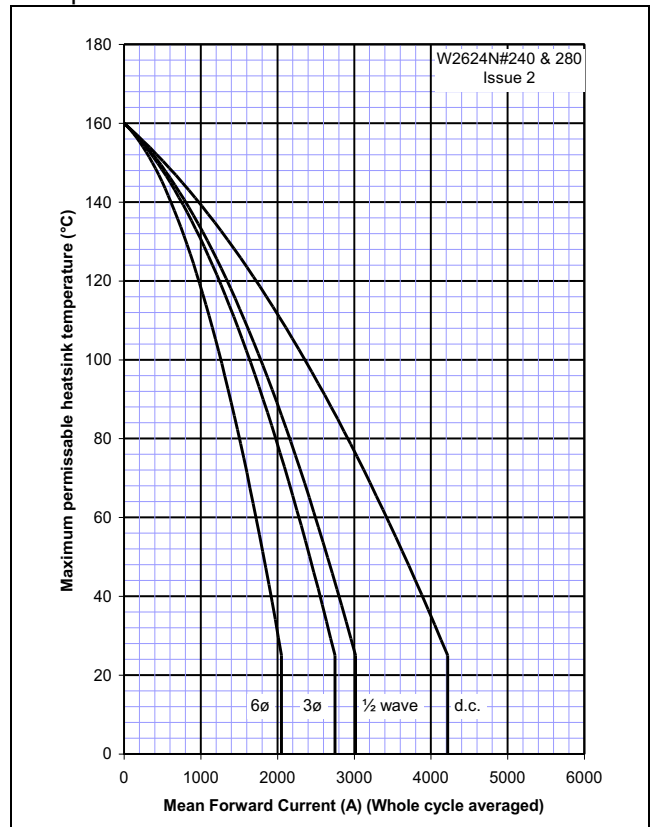

Figure 10 – Forward current vs. Power dissipation – Single Side Cooled

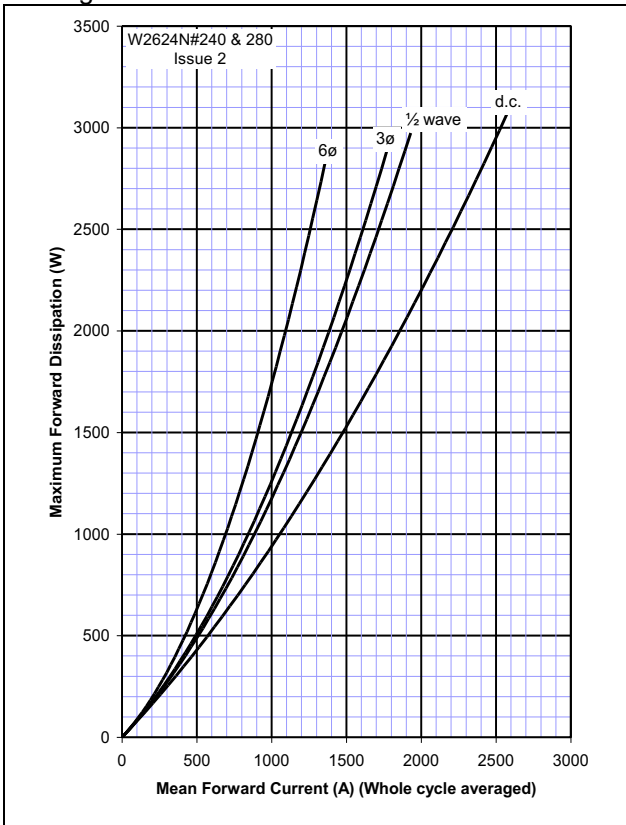
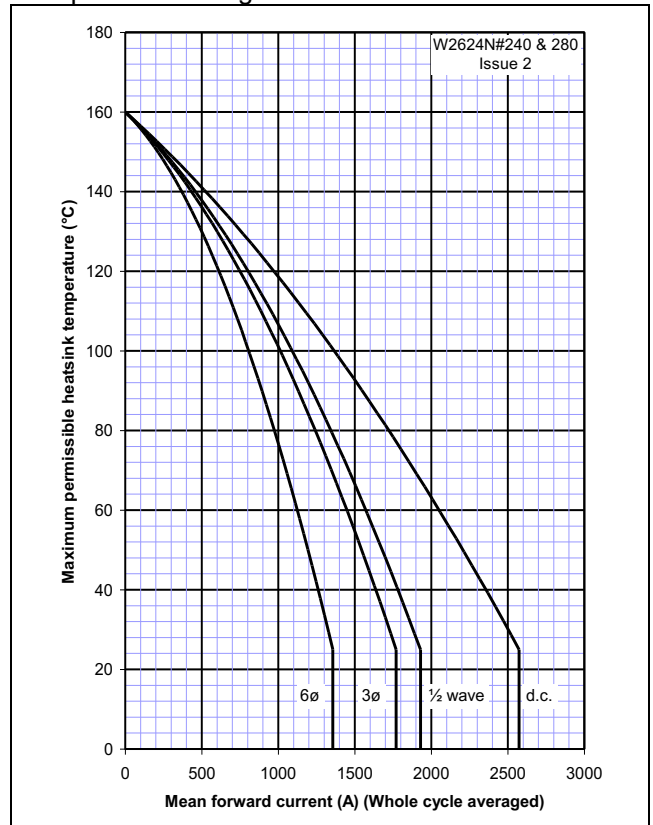
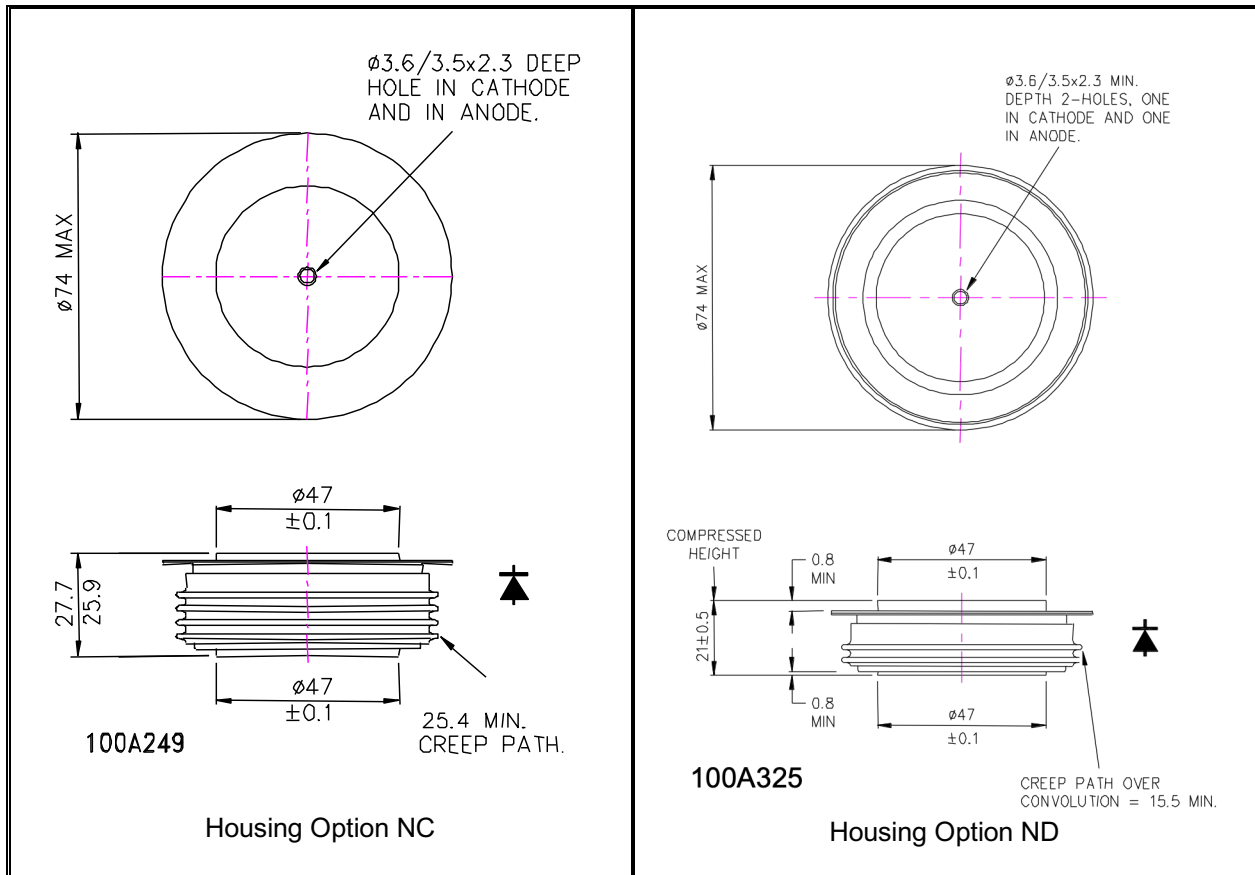

Figure 11 – Forward current vs. Heatsink temperature – Single Side Cooled





**Outline Drawing & Ordering Information**



**ORDERING INFORMATION**

(Please quote 10 digit code as below)

<b>W2624</b>	<b>N#</b>	<b>◆◆</b>	<b>0</b>
Fixed Type Code	Outline code NC = 27.7mm Clamp height ND = 21mm Clamp height	Voltage code $V_{DRM}/100$ 24 or 28	Fixed code

Example order code: W2624ND240 – 2400V  $V_{RRM}$ , 21mm clamp height capsule.

**IXYS Semiconductor GmbH**  
Edisonstraße 15  
D-68623 Lampertheim  
Tel: +49 6206 503-0  
Fax: +49 6206 503-627  
E-mail: [marcom@ixys.de](mailto:marcom@ixys.de)



**IXYS UK Westcode Ltd**  
Langley Park Way, Langley Park,  
Chippenham, Wiltshire, SN15 1GE.  
Tel: +44 (0)1249 444524  
Fax: +44 (0)1249 659448  
E-mail: [WSL.sales@westcode.com](mailto:WSL.sales@westcode.com)

**IXYS Corporation**  
1590 Buckeye Drive  
Milpitas CA 95035 7418 USA  
Tel: +1 (408) 547 9000  
Fax: +1 (408) 496 0670  
E-mail: [sales@ixys.net](mailto:sales@ixys.net)

[www.ixysuk.com](http://www.ixysuk.com)

[www.ixys.com](http://www.ixys.com)

**IXYS Long Beach Inc**  
2500 Mira Mar Avenue  
Long Beach CA 90815 USA  
Tel: +1 (562) 296 6584  
Fax: +1 (562) 296 6585  
E-mail: [service@ixyslongbeach.com](mailto:service@ixyslongbeach.com)

The information contained herein is confidential and is protected by Copyright. The information may not be used or disclosed except with the written permission of and in the manner permitted by the proprietors IXYS UK Westcode Ltd.

© IXYS UK Westcode Ltd.

In the interest of product improvement, IXYS UK Westcode Ltd. reserves the right to change specifications at any time without prior notice.

Devices with a suffix code (2-letter, 3-letter or letter/digit/letter combination) added to their generic code are not necessarily subject to the conditions and limits contained in this report.



---

Disclaimer Notice - Information furnished is believed to be accurate and reliable. However, users should independently evaluate the suitability of and test each product selected for their own applications. Littelfuse products are not designed for, and may not be used in, all applications. Read complete Disclaimer Notice at [www.littelfuse.com/disclaimer-electronics](http://www.littelfuse.com/disclaimer-electronics).