

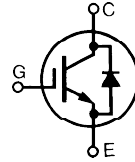
# High Voltage, High Gain BIMOSFET™ Monolithic Bipolar MOS Transistor

## IXBF22N300

$$V_{CES} = 3000V$$

$$I_{C90} = 22A$$

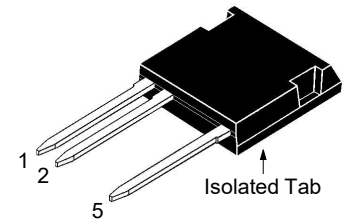
$$V_{CE(sat)} \leq 2.7V$$



(Electrically Isolated Tab)

Symbol	Test Conditions	Maximum Ratings	
$V_{CES}$	$T_J = 25^\circ C$ to $150^\circ C$	3000	V
$V_{CGR}$	$T_J = 25^\circ C$ to $150^\circ C$ , $R_{GE} = 1M\Omega$	3000	V
$V_{GES}$	Continuous	$\pm 20$	V
$V_{GEM}$	Transient	$\pm 30$	V
$I_{C25}$	$T_C = 25^\circ C$	38	A
$I_{C90}$	$T_C = 90^\circ C$	22	A
$I_{CM}$	$T_C = 25^\circ C$ , 1ms	165	A
<b>SSOA</b> <b>(RBSOA)</b>	$V_{GE} = 15V$ , $T_{VJ} = 125^\circ C$ , $R_G = 15\Omega$ Clamped Inductive Load	$I_{CM} = 180$ $V_{CES} \leq 1500$	A V
<b><math>T_{SC}</math></b> <b>(SCSOA)</b>	$V_{GE} = 15V$ , $T_J = 125^\circ C$ , $R_G = 52\Omega$ , $V_{CE} = 1500V$ , Non-Repetitive	10	$\mu s$
$P_C$	$T_C = 25^\circ C$	150	W
$T_J$		-55 ... +150	$^\circ C$
$T_{JM}$		150	$^\circ C$
$T_{stg}$		-55 ... +150	$^\circ C$
$T_L$	Maximum Lead Temperature for Soldering 1.6 mm (0.062 in.) from Case for 10s	300	$^\circ C$
$F_C$	Mounting Force	20..120 / 4.5..27	N/lb
$V_{ISOL}$	50/60Hz, 5 Seconds	4000	V~
<b>Weight</b>		5	g

### ISOPLUS i4-Pak™



1 = Gate  
2 = Emitter  
5 = Collector

### Features

- Silicon Chip on Direct-Copper Bond (DCB) Substrate
- Isolated Mounting Surface
- 4000V~ Electrical Isolation
- High Blocking Voltage
- High Peak Current Capability
- Low Saturation Voltage

### Advantages

- Low Gate Drive Requirement
- High Power Density

### Applications

- Switch-Mode and Resonant-Mode Power Supplies
- Uninterruptible Power Supplies (UPS)
- Laser Generators
- Capacitor Discharge Circuits
- AC Switches

Symbol	Test Conditions ( $T_J = 25^\circ C$ Unless Otherwise Specified)	Characteristic Values		
		Min.	Typ.	Max.
$BV_{CES}$	$I_C = 250\mu A$ , $V_{GE} = 0V$	3000		V
$V_{GE(th)}$	$I_C = 250\mu A$ , $V_{CE} = V_{GE}$	3.0		V
$I_{CES}$	$V_{CE} = V_{CES}$ , $V_{GE} = 0V$ Note 2, $T_J = 125^\circ C$			35 $\mu A$ 1.5 mA
$I_{GES}$	$V_{CE} = 0V$ , $V_{GE} = \pm 20V$			$\pm 100$ nA
$V_{CE(sat)}$	$I_C = 22A$ , $V_{GE} = 15V$ , Note 1 $T_J = 125^\circ C$		2.2 2.7	V V

Symbol Test Conditions ( $T_J = 25^\circ\text{C}$ Unless Otherwise Specified)		Characteristic Values		
		Min.	Typ.	Max.
$g_{fs}$	$I_C = 22\text{A}, V_{CE} = 10\text{V}, \text{Note 1}$	13	22	S
$C_{ies}$	$V_{CE} = 25\text{V}, V_{GE} = 0\text{V}, f = 1\text{MHz}$		2200	pF
$C_{oes}$			85	pF
$C_{res}$			30	pF
$Q_g$	$I_C = 22\text{A}, V_{GE} = 15\text{V}, V_{CE} = 1500\text{V}$		110	nC
$Q_{ge}$			13	nC
$Q_{gc}$			45	nC
$t_{d(on)}$	<b>Resistive Switching Times, <math>T_J = 25^\circ\text{C}</math></b> $I_C = 22\text{A}, V_{GE} = 15\text{V}$ $V_{CE} = 960\text{V}, R_G = 15\Omega$		46	ns
$t_r$			360	ns
$t_{d(off)}$			205	ns
$t_f$			1820	ns
$t_{d(on)}$	<b>Resistive Switching Times, <math>T_J = 125^\circ\text{C}</math></b> $I_C = 22\text{A}, V_{GE} = 15\text{V}$ $V_{CE} = 960\text{V}, R_G = 15\Omega$		43	ns
$t_r$			700	ns
$t_{d(off)}$			220	ns
$t_f$			1650	ns
$R_{thJC}$				0.83 $^\circ\text{C/W}$
$R_{thCS}$		0.15		$^\circ\text{C/W}$

**Reverse Diode**

Symbol Test Conditions ( $T_J = 25^\circ\text{C}$ Unless Otherwise Specified)		Characteristic Values		
		Min.	Typ.	Max.
$V_F$	$I_F = 22\text{A}, V_{GE} = 0\text{V}, \text{Note 1}$			2.7 V
$t_{rr}$	$I_F = 11\text{A}, V_{GE} = 0\text{V}, -di_F/dt = 100\text{A}/\mu\text{s}$ $V_R = 100\text{V}, V_{GE} = 0\text{V}$		1.4	$\mu\text{s}$
$I_{RM}$			30	A
$Q_{RM}$			21	$\mu\text{C}$

**Notes:**

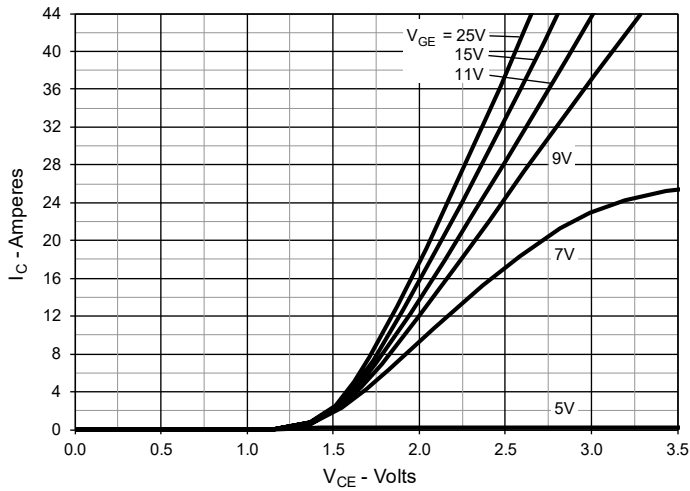
1. Pulse test,  $t \leq 300\mu\text{s}$ , duty cycle,  $d \leq 2\%$ .
2. Device must be heatsunk for high temperature leakage current measurements to avoid thermal runaway.

Additional provisions for lead-to-lead voltage isolation are required at  $V_{CE} > 1200\text{V}$ .

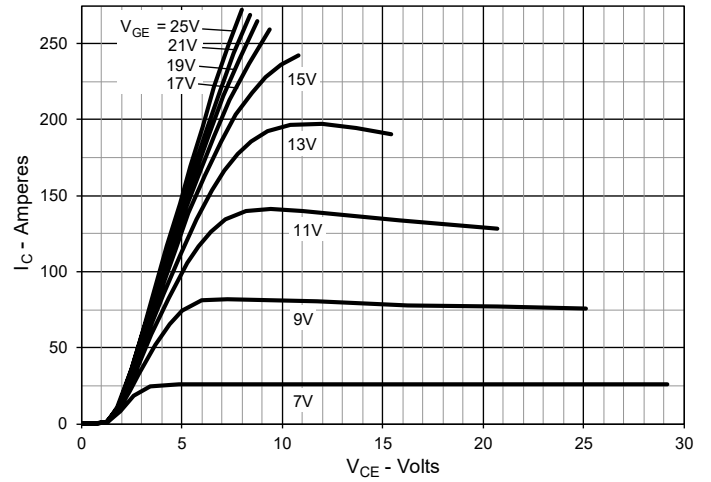
Littelfuse reserves the right to change limits, test conditions and dimensions.

IXYS MOSFETs and IGBTs are covered by one or more of the following U.S. patents:	4,835,592	4,931,844	5,049,961	5,237,481	6,162,665	6,404,065 B1	6,683,344	6,727,585	7,005,734 B2	7,157,338B2
	4,860,072	5,017,508	5,063,307	5,381,025	6,259,123 B1	6,534,343	6,710,405 B2	6,759,692	7,063,975 B2	
	4,881,106	5,034,796	5,187,117	5,486,715	6,306,728 B1	6,583,505	6,710,463	6,771,478 B2	7,071,537	

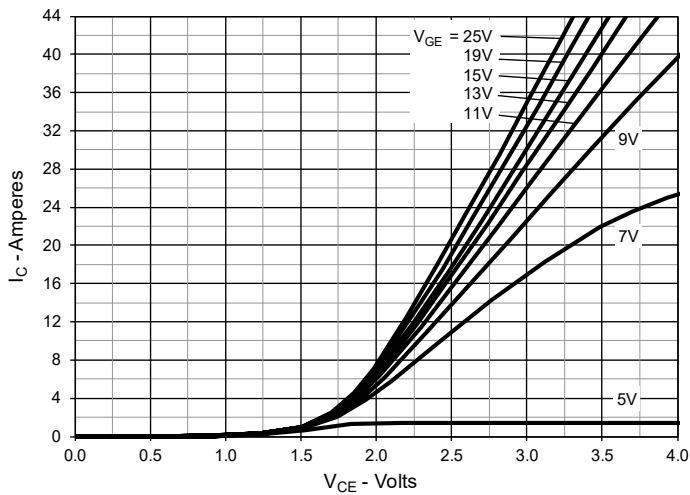
**Fig. 1. Output Characteristics @  $T_J = 25^\circ\text{C}$**



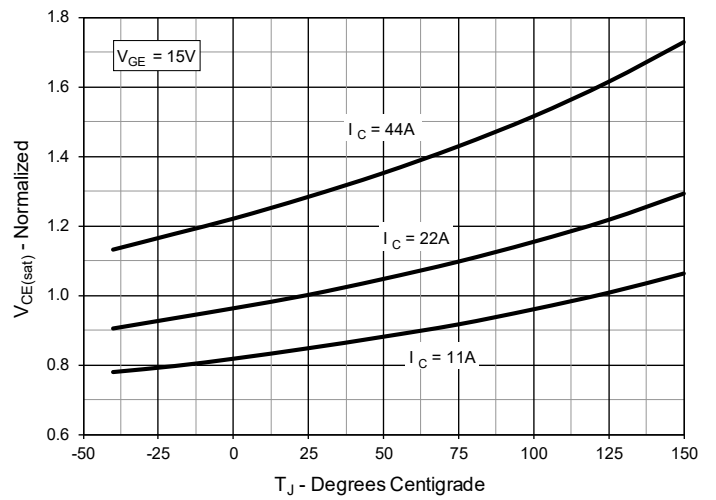
**Fig. 2. Extended Output Characteristics @  $T_J = 25^\circ\text{C}$**



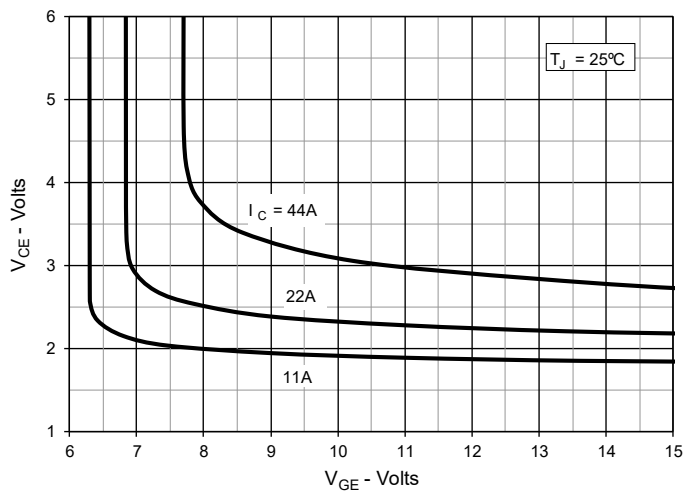
**Fig. 3. Output Characteristics @  $T_J = 125^\circ\text{C}$**



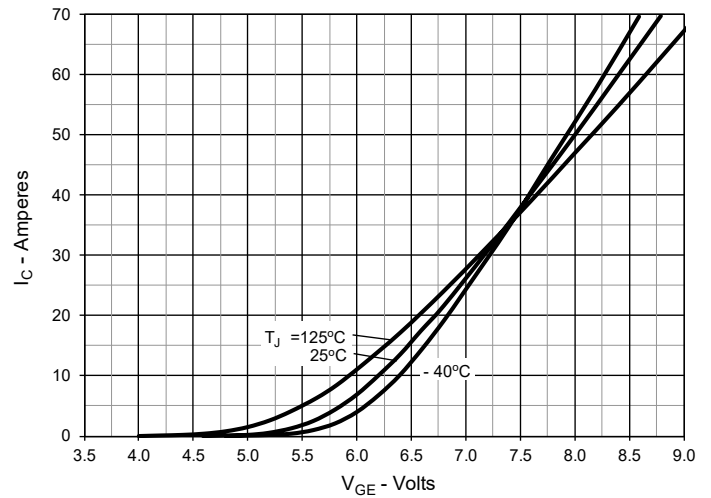
**Fig. 4. Dependence of  $V_{CE(sat)}$  on Junction Temperature**

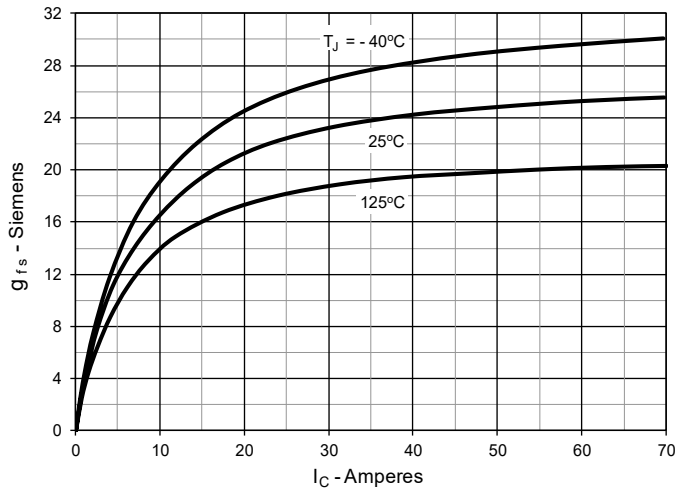
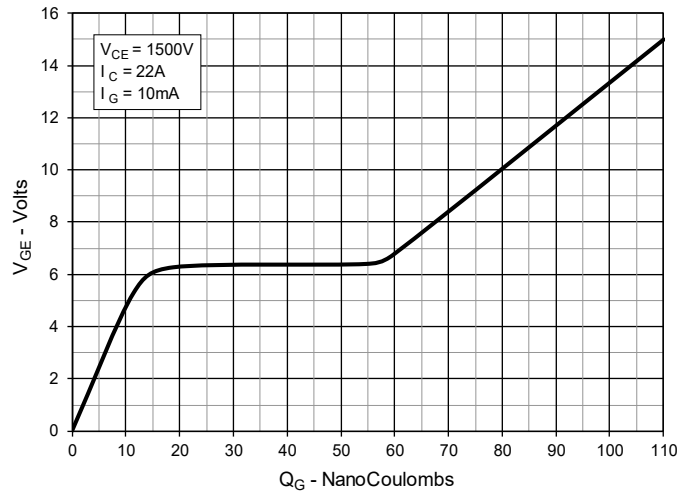
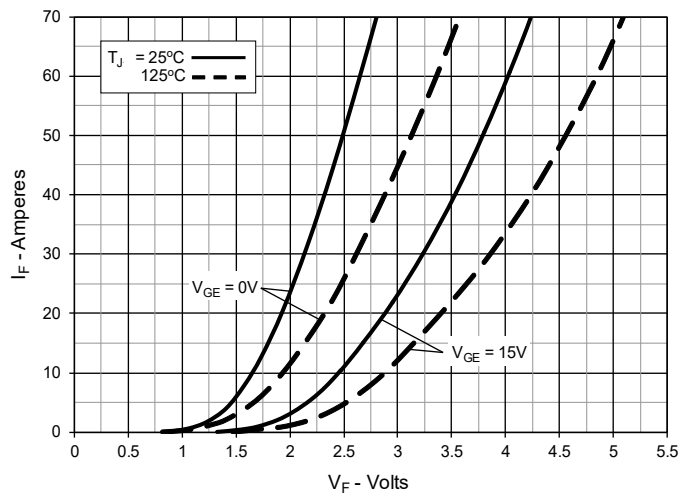
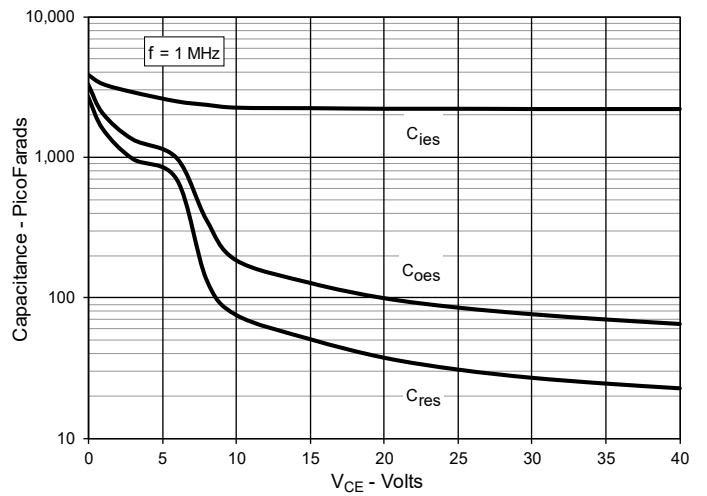
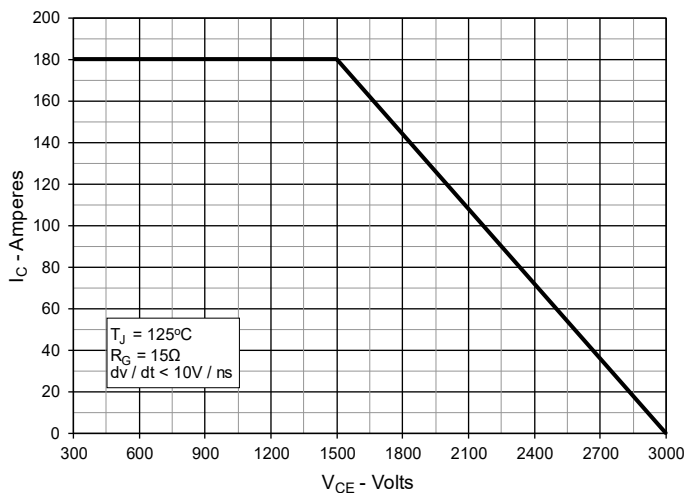
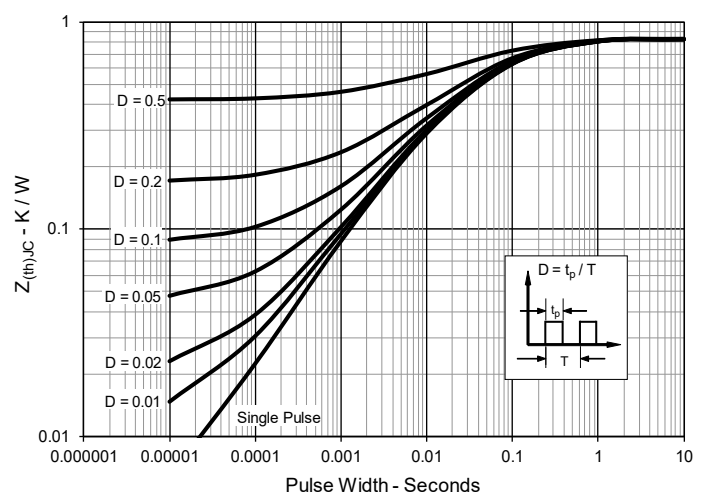


**Fig. 5. Collector-to-Emitter Voltage vs. Gate-to-Emitter Voltage**

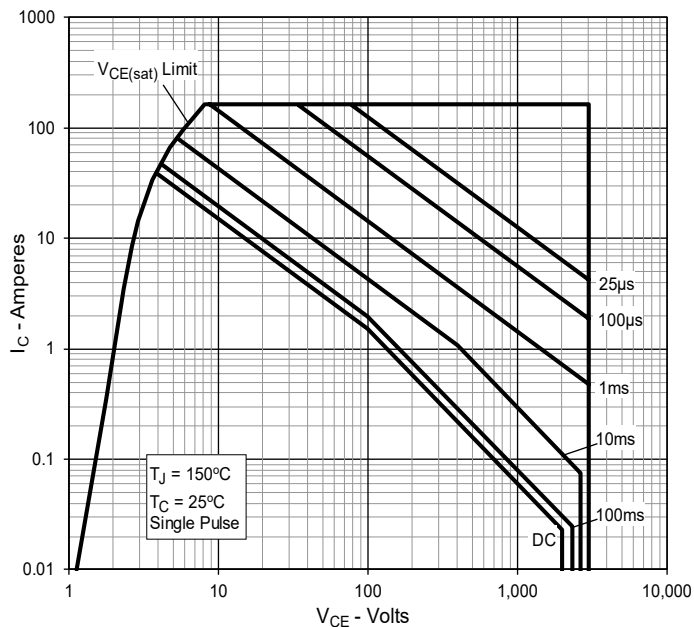


**Fig. 6. Input Admittance**

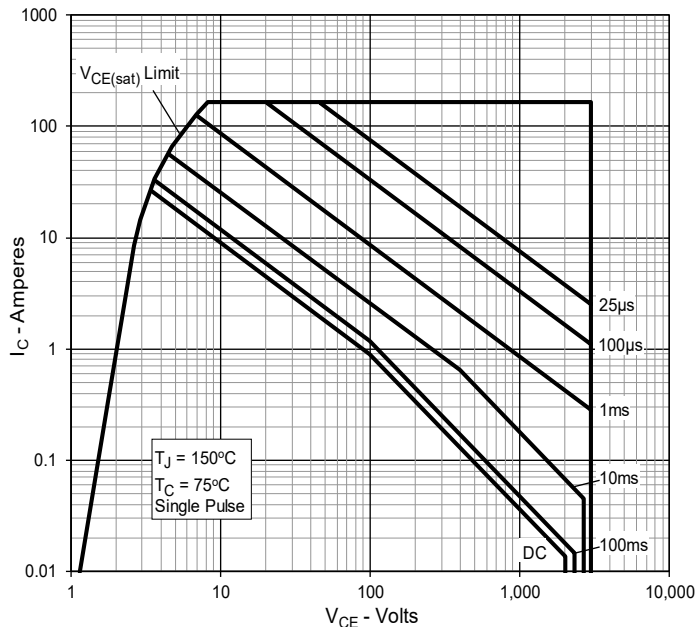


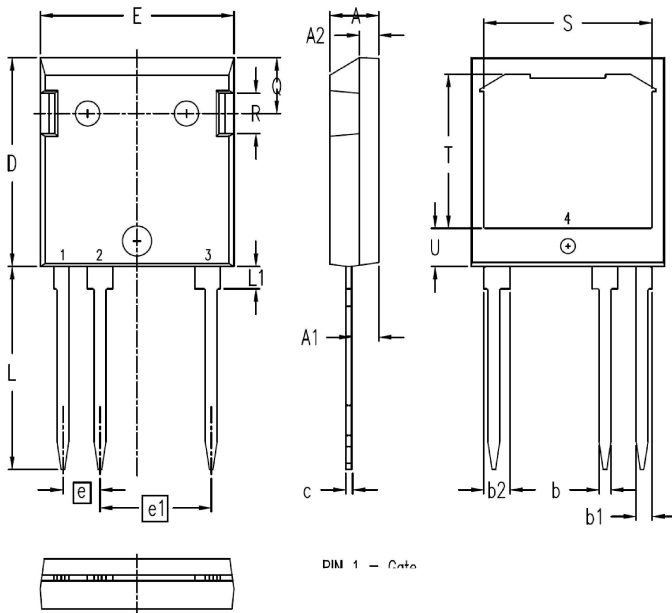
**Fig. 7. Transconductance**

**Fig. 8. Gate Charge**

**Fig. 9. Forward Voltage Drop of Intrinsic Diode**

**Fig. 10. Capacitance**

**Fig. 11. Reverse-Bias Safe Operating Area**

**Fig. 12. Maximum Transient Thermal Impedance**


**Fig. 13. Forward-Bias Safe Operating Area @  $T_C = 25^\circ\text{C}$**



**Fig. 14. Forward-Bias Safe Operating Area @  $T_C = 75^\circ\text{C}$**



**ISOPLUS i4-Pak Outline**


**1 = Gate**  
**2 = Emitter**  
**3,4 = Colector**

SYM	INCHES		MILLIMETERS	
	MIN	MAX	MIN	MAX
A	.193	.201	4.90	5.10
A1	.106	.114	2.70	2.90
A2	.075	.083	1.90	2.10
b	.047	.055	1.20	1.40
b1	.061	.069	1.55	1.75
b2	.087	.094	2.20	2.40
c	.020	.029	0.51	0.74
D	.819	.846	20.80	21.50
E	.768	.799	19.50	20.30
e	.150 BSC		3.81 BSC	
e1	.450 BSC		11.43 BSC	
L	.780	.838	19.80	21.30
L1	.083	.094	2.10	2.40
Q	.213	.236	5.40	6.00
R	.157	.169	4.00	4.30
S	.673	.685	17.10	17.40
T	.602	.614	15.30	15.60
U	.142	.154	3.60	3.90