

High Voltage BIMOSFET™

in High Voltage ISOPLUS i4-PAC™

Monolithic Bipolar MOS Transistor

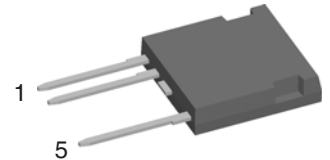
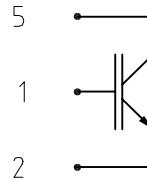

$$I_{C25} = 28 \text{ A}$$

$$V_{CES} = 1600 \text{ V}$$

$$V_{CE(sat)} = 6.2 \text{ V}$$

$$t_f = 40 \text{ ns}$$

IGBT			
Symbol	Conditions	Maximum Ratings	
V_{CES}	$T_{VJ} = 25^\circ\text{C to } 150^\circ\text{C}$	1600	V
V_{GES}		± 20	V
I_{C25}	$T_C = 25^\circ\text{C}$	28	A
I_{C90}	$T_C = 90^\circ\text{C}$	16	A
I_{CM} V_{CEK}	$V_{GE} = 15/0 \text{ V}; R_G = 22 \Omega; T_{VJ} = 125^\circ\text{C}$ RBSOA, Clamped inductive load; $L = 100 \mu\text{H}$	40	A
		$0.8V_{CES}$	
P_{tot}	$T_C = 25^\circ\text{C}$	250	W

Features

- High Voltage BIMOSFET™
 - substitute for high voltage MOSFETs with significantly lower voltage drop
 - fast switching for high frequency operation
 - reverse conduction capability
- ISOPLUS i4-PAC™ high voltage package
 - isolated back surface
 - enlarged creepage towards heatsink
 - enlarged creepage between high voltage pins
 - application friendly pinout
 - high reliability
 - industry standard outline

Symbol	Conditions	Characteristic Values ($T_{VJ} = 25^\circ\text{C}$, unless otherwise specified)			
		min.	typ.	max.	
$V_{CE(sat)}$	$I_C = 20 \text{ A}; V_{GE} = 15 \text{ V}; T_{VJ} = 25^\circ\text{C}$ $T_{VJ} = 125^\circ\text{C}$		6.2 6.9	7.1 V	
$V_{GE(th)}$	$I_C = 2 \text{ mA}; V_{GE} = V_{CE}$	4		8 V	
I_{CES}	$V_{CE} = 0.8V_{CES}; V_{GE} = 0 \text{ V}; T_{VJ} = 25^\circ\text{C}$ $T_{VJ} = 125^\circ\text{C}$		0.8	0.4 mA mA	
I_{GES}	$V_{CE} = 0 \text{ V}; V_{GE} = \pm 20 \text{ V}$			500 nA	
$t_{d(on)}$ t_r $t_{d(off)}$ t_f	Inductive load, $T_{VJ} = 125^\circ\text{C}$ $V_{CE} = 960 \text{ V}; I_C = 25 \text{ A}$ $V_{GE} = 15/0 \text{ V}; R_G = 22 \Omega$		200 60 300 40	ns ns ns ns	
C_{ies}		$V_{CE} = 25 \text{ V}; V_{GE} = 0 \text{ V}; f = 1 \text{ MHz}$		3300	pF
Q_{Gon}		$V_{CE} = 600 \text{ V}; V_{GE} = 15 \text{ V}; I_C = 20 \text{ A}$		130	nC
V_F		(reverse conduction); $I_F = 20 \text{ A}$		2.5	V
R_{thJC}				0.5 K/W	

Applications

- switched mode power supplies
- DC-DC converters
- resonant converters
- lamp ballasts
- laser generators, x ray generators

Component

Symbol	Conditions	Maximum Ratings	
T_{VJ}		-55...+150	°C
T_{stg}		-55...+125	°C
V_{ISOL}	$I_{ISOL} \leq 1 \text{ mA}; 50/60 \text{ Hz}$	2500	V~
F_c	mounting force with clip	20...120	N

Symbol	Conditions	Characteristic Values		
		min.	typ.	max.
d_s, d_A	C pin - E pin	7		mm
d_s, d_A	pin - backside metal	5.5		mm
R_{thCH}	with heatsink compound		0.15	K/W
Weight			9	g

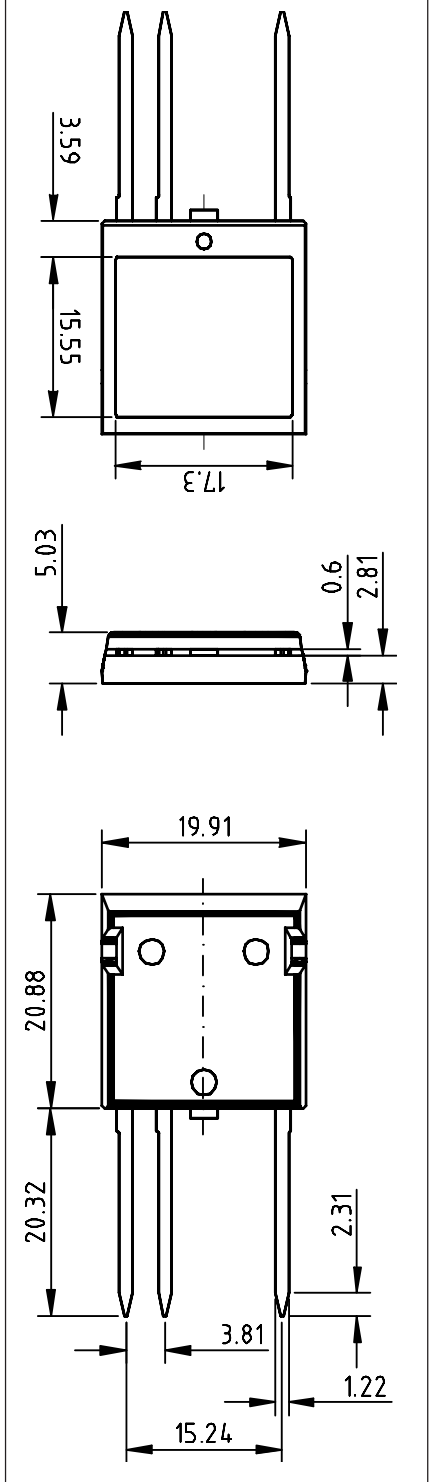
Dimensions in mm (1 mm = 0.0394")

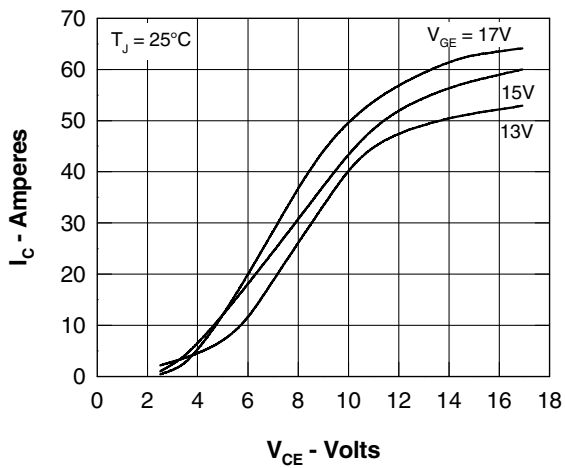

Fig. 1 Typ. Output Characteristics

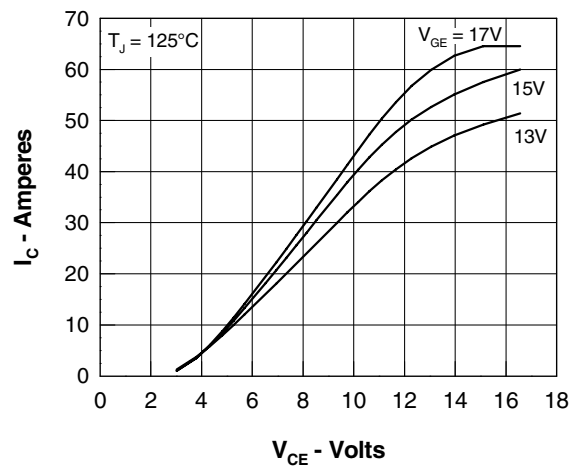

Fig. 2 Typ. Output Characteristics

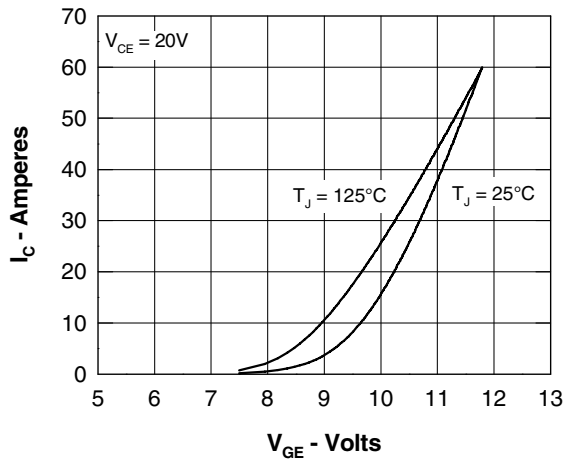

Fig. 3 Typ. Transfer Characteristics

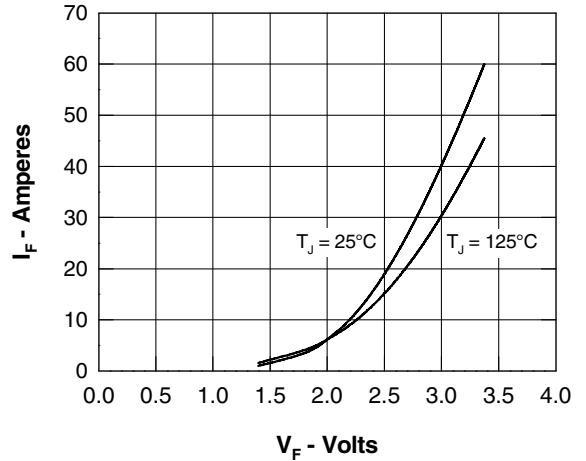

Fig. 4 Typ. Characteristics of Reverse Conduction

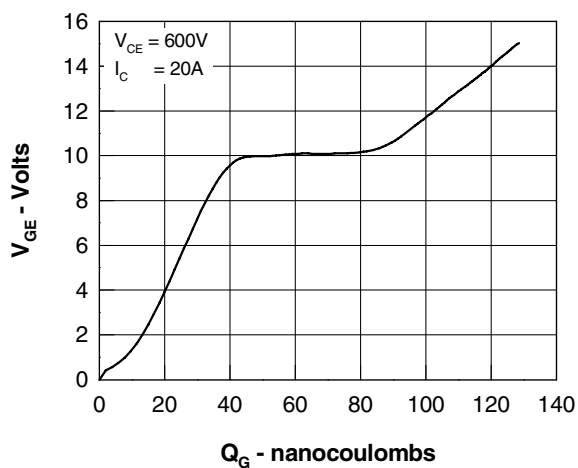

Fig. 5 Typ. Gate Charge characteristics

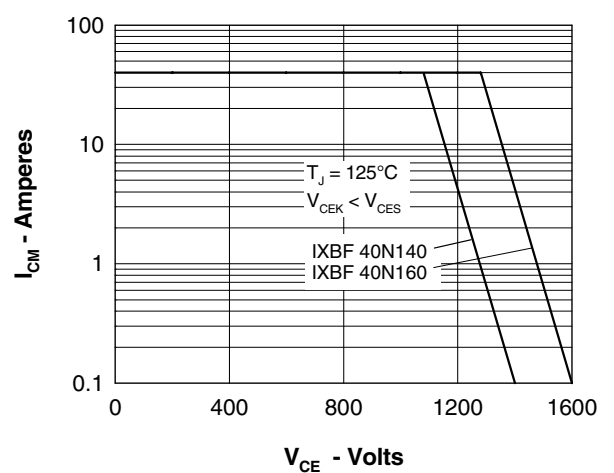

Fig. 6 Reverse Based Safe Operating Area RBSOA

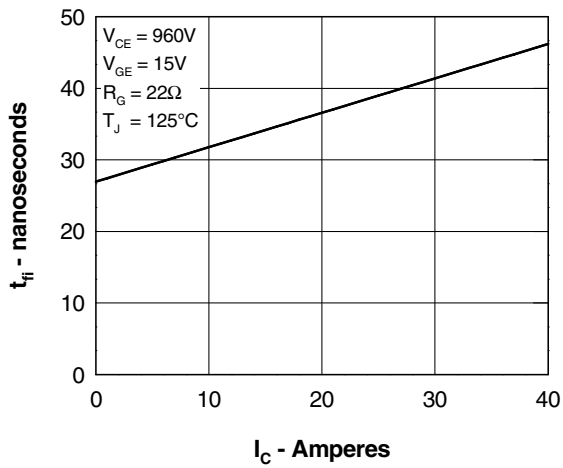

Fig. 7 Typ. Fall Time

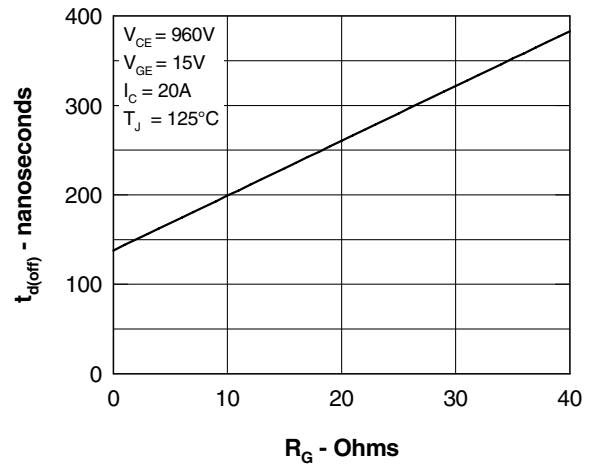

Fig. 8 Typ. Turn Off Delay Time

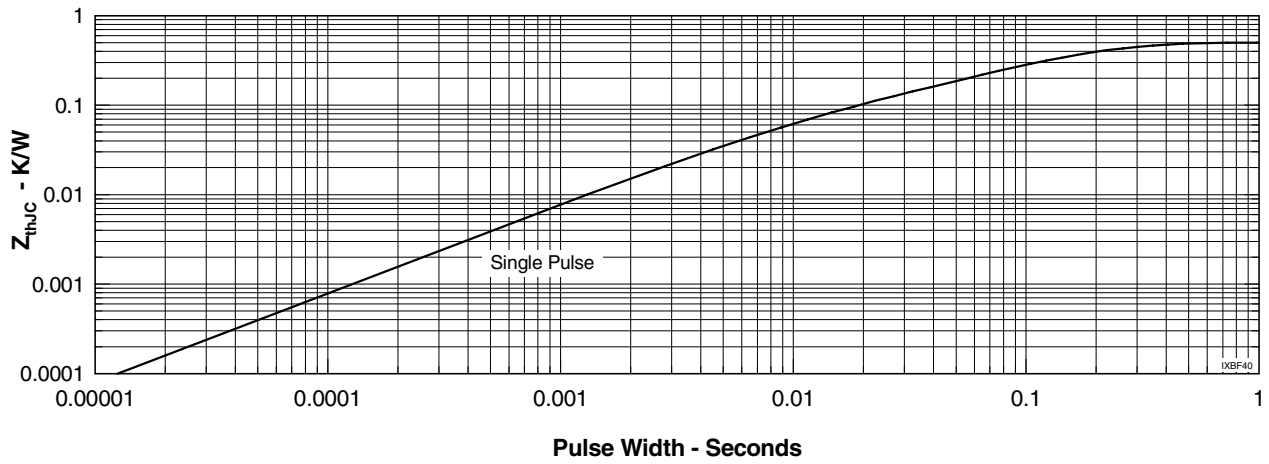

Fig. 9 Typ. Transient Thermal Impedance



Disclaimer Notice - Information furnished is believed to be accurate and reliable. However, users should independently evaluate the suitability of and test each product selected for their own applications. Littelfuse products are not designed for, and may not be used in, all applications. Read complete Disclaimer Notice at www.littelfuse.com/disclaimer-electronics.