

High Voltage, High Gain BIMOSFET™

IXBF55N300

Monolithic Bipolar MOS Transistor

(Electrically Isolated Tab)

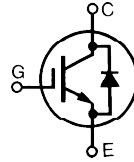

$$V_{CES} = 3000V$$

$$I_{C110} = 34A$$

$$V_{CE(sat)} \leq 3.2V$$

Symbol	Test Conditions	Maximum Ratings	
V_{CES}	$T_C = 25^\circ C$ to $150^\circ C$	3000	V
V_{CGR}	$T_J = 25^\circ C$ to $150^\circ C$, $R_{GE} = 1M\Omega$	3000	V
V_{GES}	Continuous	± 25	V
V_{GEM}	Transient	± 35	V
I_{C25}	$T_C = 25^\circ C$	86	A
I_{C110}	$T_C = 110^\circ C$	34	A
I_{CM}	$T_C = 25^\circ C$, 1ms	600	A
SSOA (RBSOA)	$V_{GE} = 15V$, $T_{VJ} = 125^\circ C$, $R_G = 2\Omega$	$I_{CM} = 110$	A
	Clamped Inductive Load	1500	V
T_{SC} (SCSOA)	$V_{GE} = 15V$, $T_J = 125^\circ C$, $R_G = 10\Omega$, $V_{CE} = 1250V$, Non-Repetitive	10	μs
P_C	$T_C = 25^\circ C$	357	W
T_J		-55 ... +150	$^\circ C$
T_{JM}		150	$^\circ C$
T_{stg}		-55 ... +150	$^\circ C$
T_L	Maximum Lead Temperature for Soldering 1.6 mm (0.062 in.) from Case for 10s	300	$^\circ C$
F_C	Mounting Force	20..120 / 4.5..27	N/lb
V_{ISOL}	50/60Hz, 1 Minute	4000	V~
Weight		5	g

ISOPLUS i4-Pak™

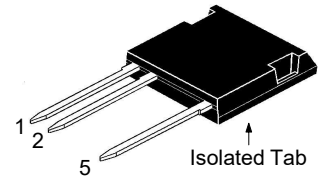

1 = Gate
2 = Emitter

5 = Collector

Features

- Silicon Chip on Direct-Copper Bond (DCB) Substrate
- Isolated Mounting Surface
- 4000V~ Electrical Isolation
- High Blocking Voltage
- High Peak Current Capability
- Low Saturation Voltage

Advantages

- Low Gate Drive Requirement
- High Power Density

Applications

- Switch-Mode and Resonant-Mode Power Supplies
- Uninterruptible Power Supplies (UPS)
- Laser Generators
- Capacitor Discharge Circuits
- AC Switches

Symbol	Test Conditions ($T_J = 25^\circ C$ Unless Otherwise Specified)	Characteristic Values		
		Min.	Typ.	Max.
BV_{CES}	$I_C = 1mA$, $V_{GE} = 0V$	3000		V
$V_{GE(th)}$	$I_C = 4mA$, $V_{CE} = V_{GE}$	3.0		5.0 V
I_{CES}	$V_{CE} = V_{CES}$, $V_{GE} = 0V$ Note 2, $T_J = 125^\circ C$			50 μA 3 mA
I_{GES}	$V_{CE} = 0V$, $V_{GE} = \pm 25V$			± 200 nA
$V_{CE(sat)}$	$I_C = 55A$, $V_{GE} = 15V$, Note 1 $T_J = 125^\circ C$		2.7	3.2 V
			3.3	V

Symbol Test Conditions ($T_J = 25^\circ\text{C}$ Unless Otherwise Specified)		Characteristic Values		
		Min.	Typ.	Max.
g_{fs}	$I_C = 55\text{A}, V_{CE} = 10\text{V}, \text{Note } 1$	32	50	S
C_{ies}	$V_{CE} = 25\text{V}, V_{GE} = 0\text{V}, f = 1\text{MHz}$		7300	pF
C_{oes}			275	pF
C_{res}			83	pF
Q_g	$I_C = 55\text{A}, V_{GE} = 15\text{V}, V_{CE} = 1000\text{V}$		335	nC
Q_{ge}			47	nC
Q_{gc}			130	nC
$t_{d(on)}$	Resistive Switching Times, $T_J = 25^\circ\text{C}$ $I_C = 110\text{A}, V_{GE} = 15\text{V}$ $V_{CE} = 1250\text{V}, R_G = 2\Omega$		54	ns
t_r			307	ns
$t_{d(off)}$			230	ns
t_f			268	ns
$t_{d(on)}$	Resistive Switching Times, $T_J = 125^\circ\text{C}$ $I_C = 110\text{A}, V_{GE} = 15\text{V}$ $V_{CE} = 1250\text{V}, R_G = 2\Omega$		52	ns
t_r			585	ns
$t_{d(off)}$			215	ns
t_f			260	ns
R_{thJC}				0.35 $^\circ\text{C/W}$
R_{thCS}		0.15		$^\circ\text{C/W}$

Reverse Diode

Symbol Test Conditions ($T_J = 25^\circ\text{C}$ Unless Otherwise Specified)		Characteristic Values		
		Min.	Typ.	Max.
V_F	$I_F = 55\text{A}, V_{GE} = 0\text{V}, \text{Note } 1$			2.5 V
t_{rr}	$I_F = 28\text{A}, V_{GE} = 0\text{V}, -di_F/dt = 100\text{A}/\mu\text{s}$		1.9	μs
I_{RM}		$V_R = 100\text{V}, V_{GE} = 0\text{V}$		54

Notes:

1. Pulse test, $t < 300\mu\text{s}$, duty cycle, $d < 2\%$.
2. Device must be heatsunk for high-temperature leakage current measurements to avoid thermal runaway.

Additional provisions for lead-to-lead isolation are required at $V_{CE} > 1250\text{V}$.

Littelfuse reserves the right to change limits, test conditions and dimensions.

IXYS MOSFETs and IGBTs are covered by one or more of the following U.S. patents:	4,835,592	4,931,844	5,049,961	5,237,481	6,162,665	6,404,065B1	6,683,344	6,727,585	7,005,734B2	7,157,338B2
	4,860,072	5,017,508	5,063,307	5,381,025	6,259,123B1	6,534,343	6,710,405B2	6,759,692	7,063,975B2	
	4,881,106	5,034,796	5,187,117	5,486,715	6,306,728B1	6,583,505	6,710,463	6,771,478B2	7,071,537	

Fig. 1. Output Characteristics @ $T_J = 25^\circ\text{C}$

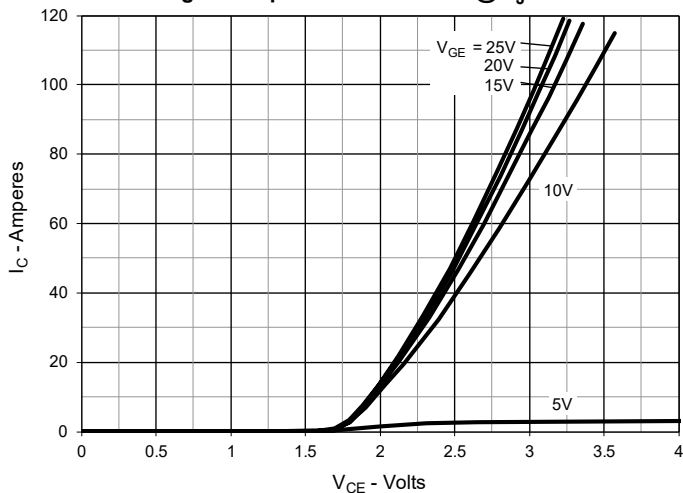

Fig. 2. Extended Output Characteristics @ $T_J = 25^\circ\text{C}$

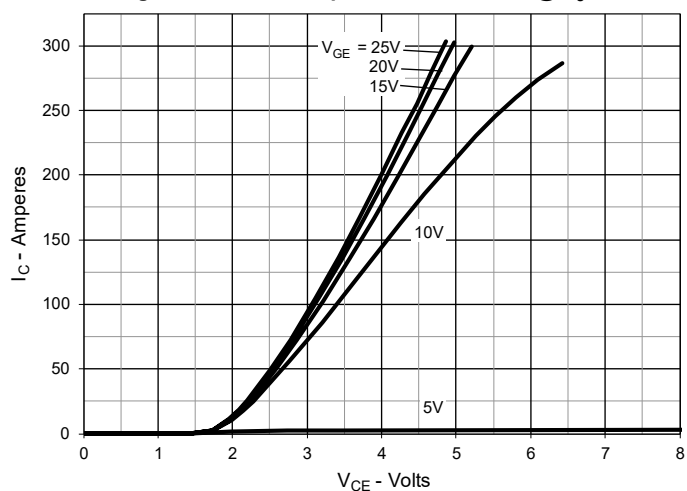

Fig. 3. Output Characteristics @ $T_J = 125^\circ\text{C}$

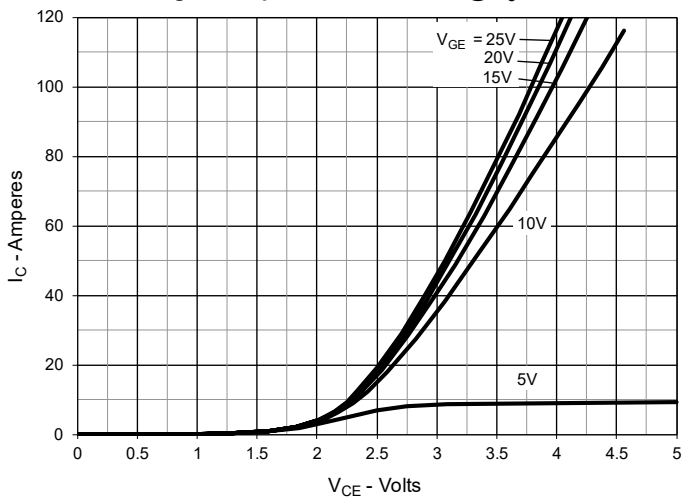

Fig. 4. Dependence of $V_{CE(sat)}$ on Junction Temperature

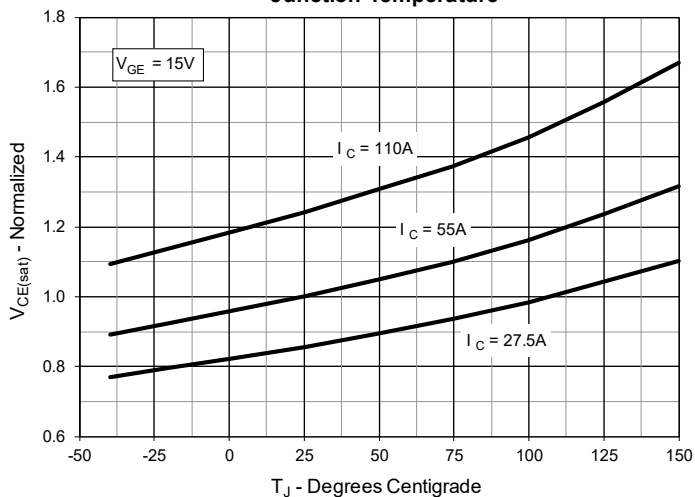

Fig. 5. Collector-to-Emitter Voltage vs. Gate-to-Emitter Voltage

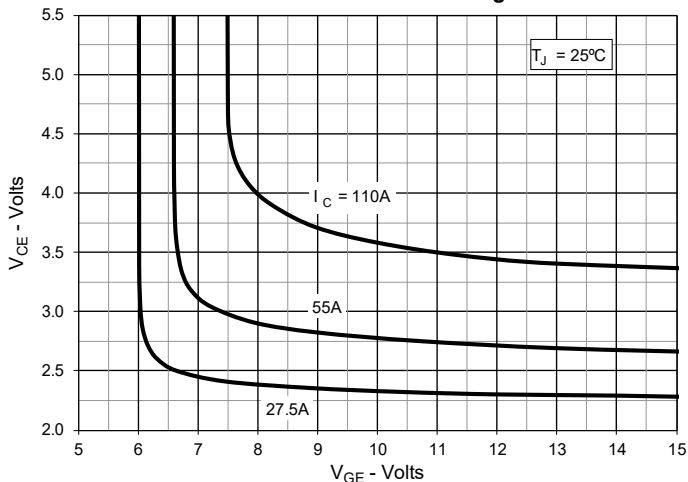

Fig. 6. Input Admittance

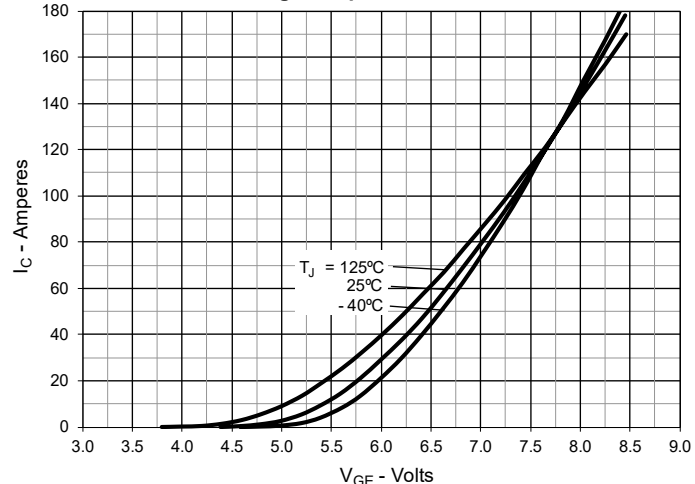

Fig. 7. Transconductance

Fig. 8. Forward Voltage Drop of Intrinsic Diode

Fig. 9. Gate Charge

Fig. 10. Capacitance

Fig. 11. Reverse-Bias Safe Operating Area

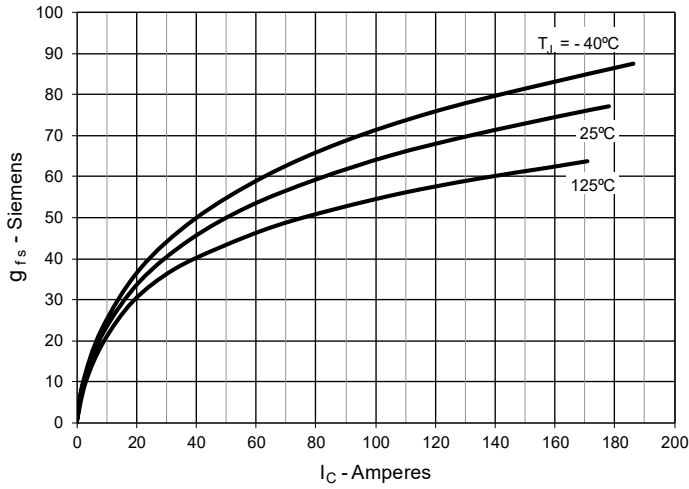
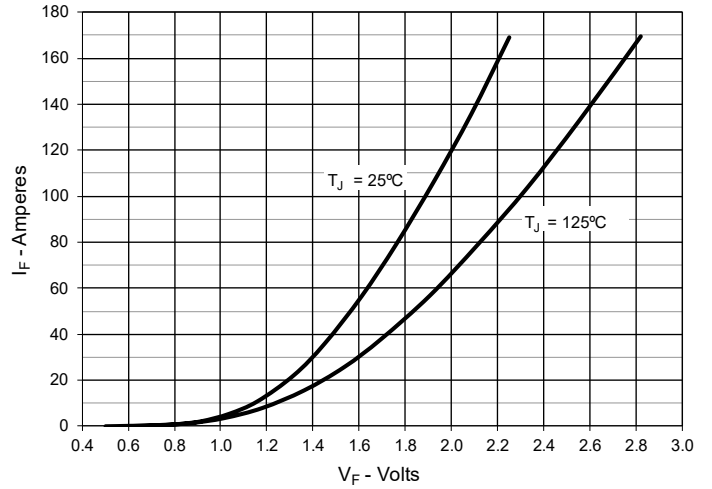
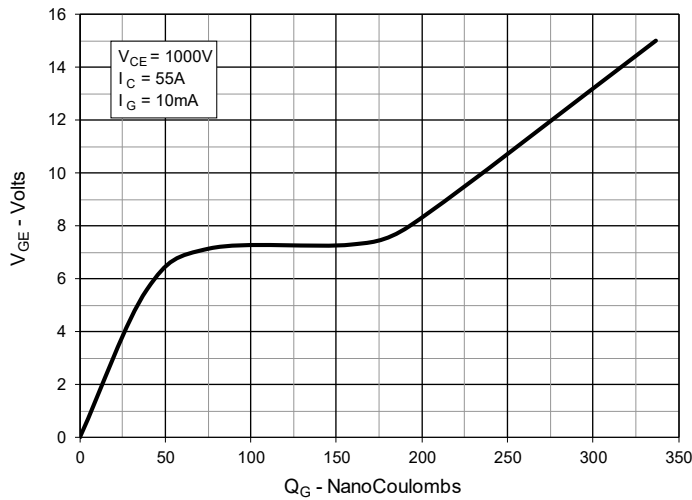
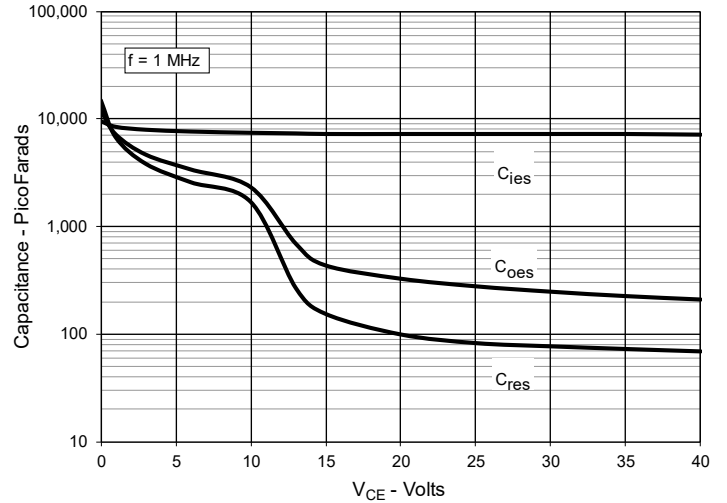
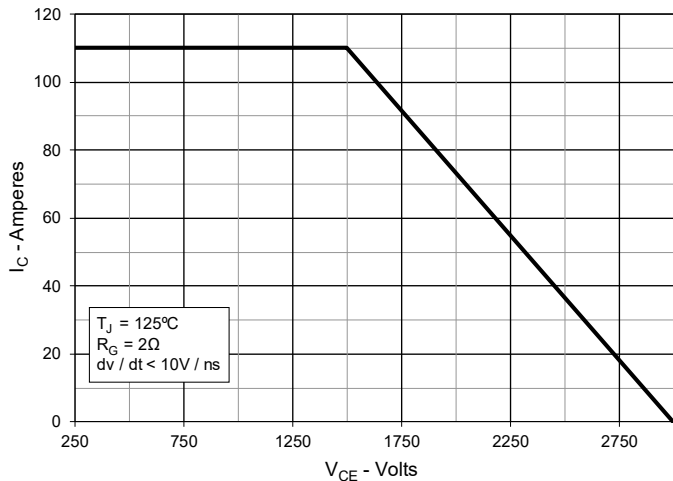
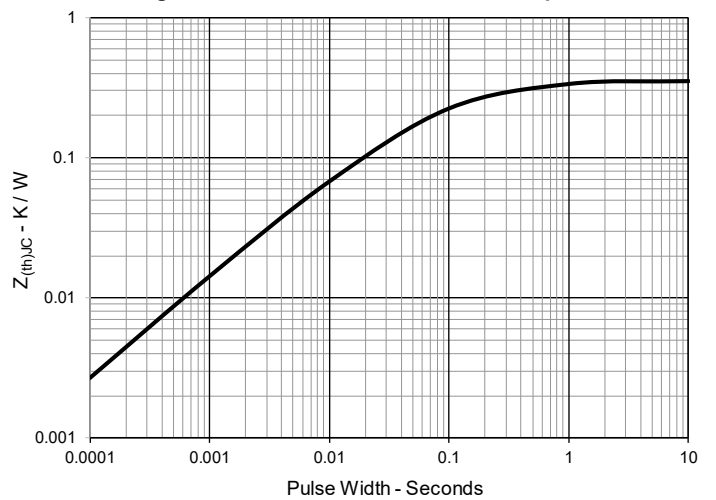
Fig. 12. Maximum Transient Thermal Impedance

Fig. 13. Resistive Turn-on Rise Time vs. Junction Temperature

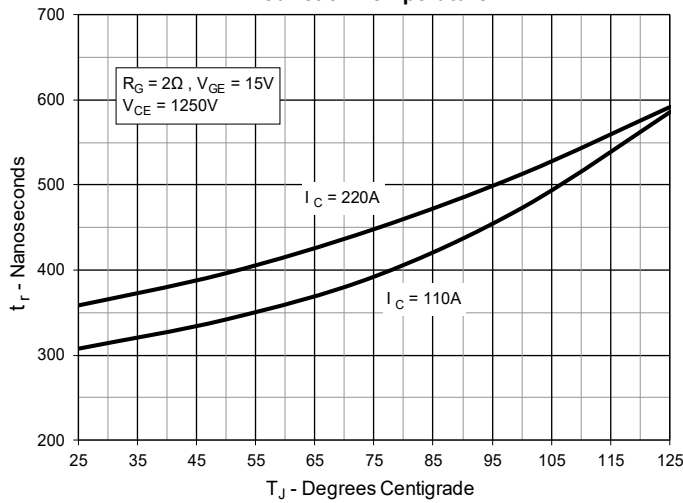

Fig. 14. Resistive Turn-on Rise Time vs. Collector Current

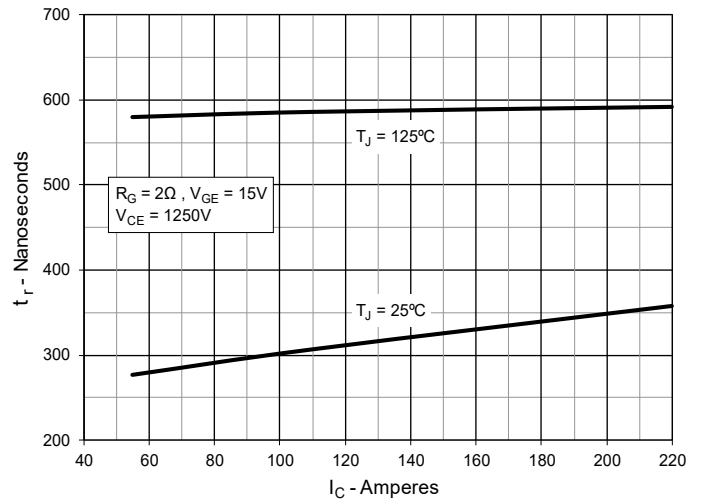

Fig. 15. Resistive Turn-on Switching Times vs. Gate Resistance

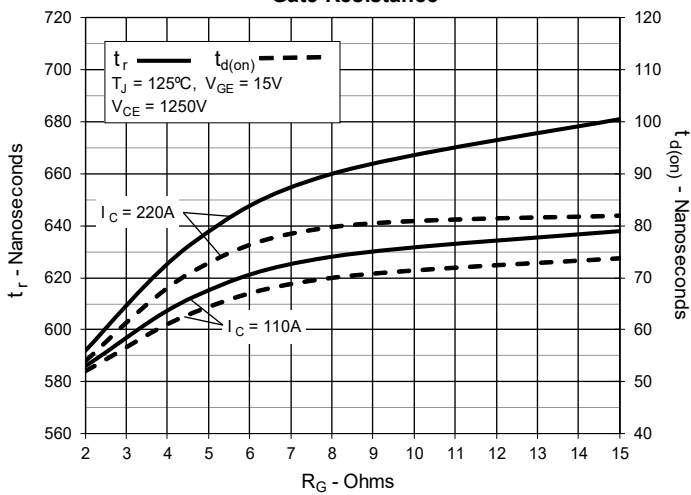

Fig. 16. Resistive Turn-off Switching Times vs. Junction Temperature

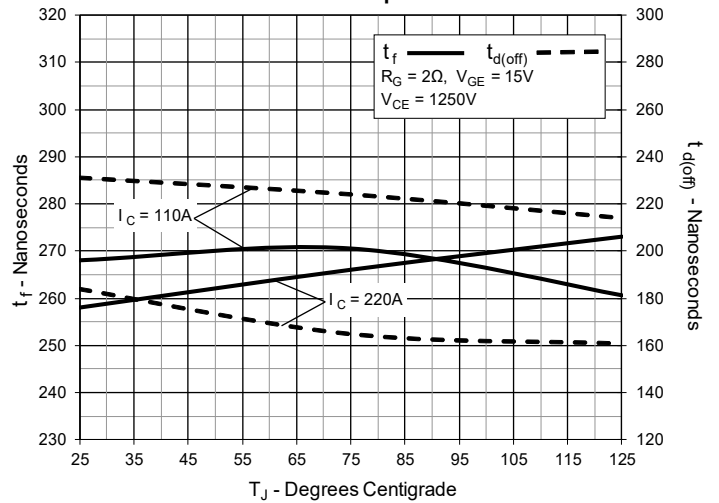

Fig. 17. Resistive Turn-off Switching Times vs. Collector Current

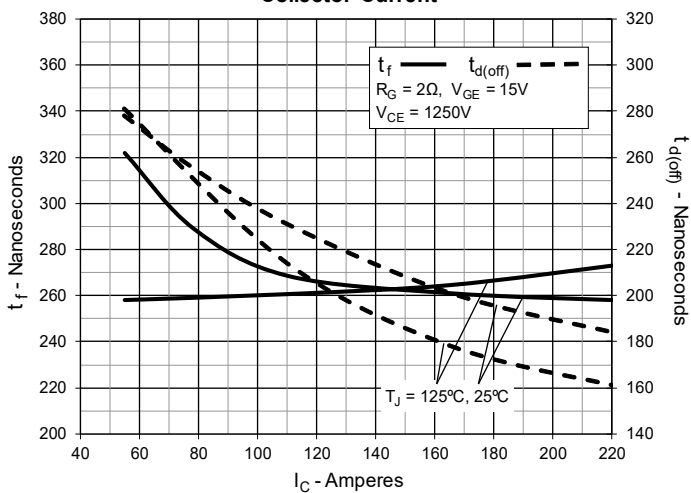

Fig. 18. Resistive Turn-off Switching Times vs. Gate Resistance

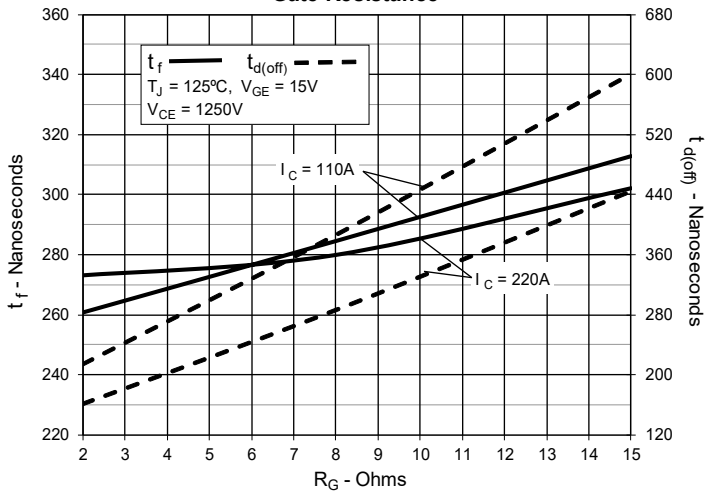

Fig. 19. Forward-Bias Safe Operating Area
@ $T_C = 25^\circ\text{C}$

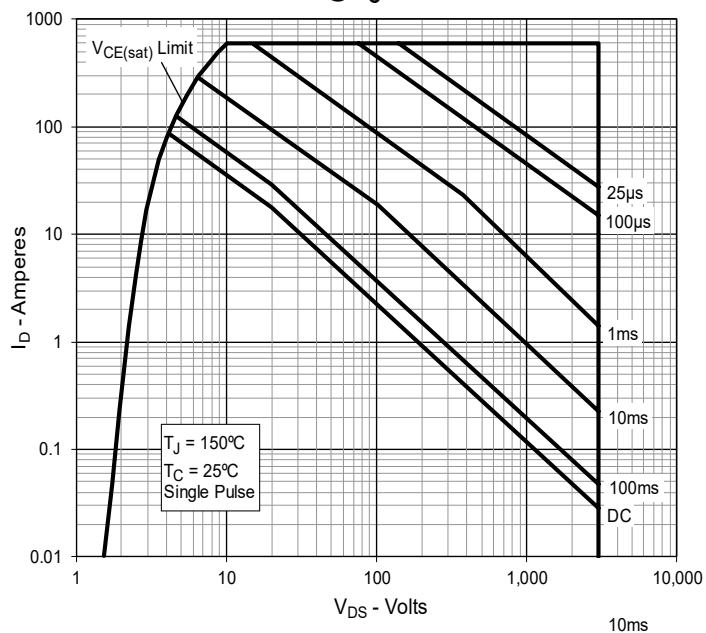
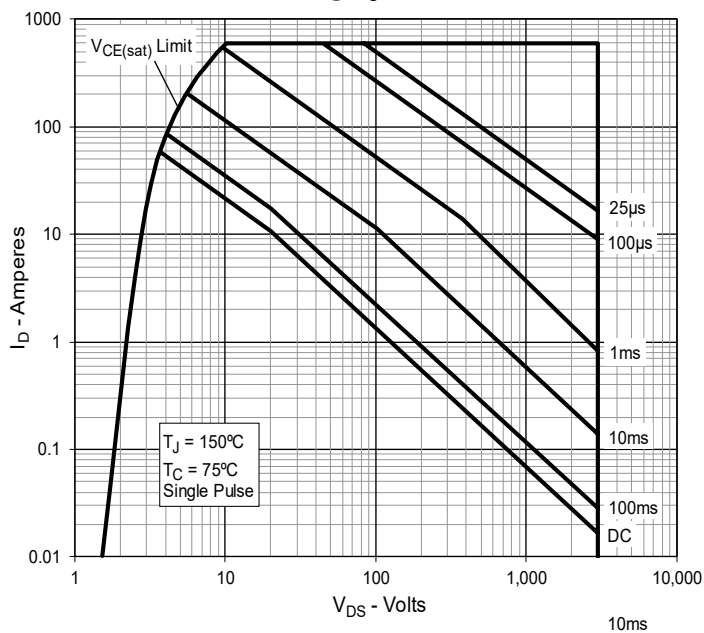
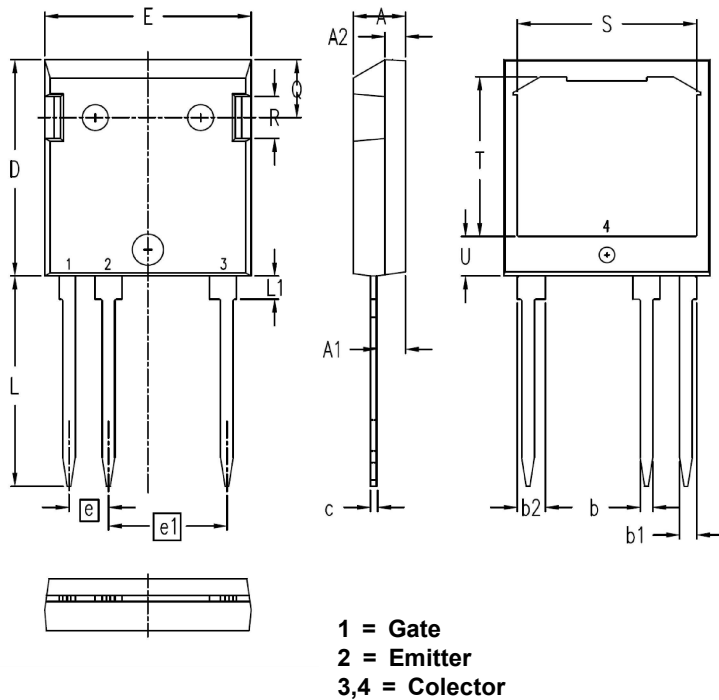

Fig. 20. Forward-Bias Safe Operating Area
@ $T_C = 75^\circ\text{C}$



Littelfuse reserves the right to change limits, test conditions and dimensions.

ISOPLUS i4-Pak Outline

SYM	INCHES		MILLIMETERS	
	MIN	MAX	MIN	MAX
A	.193	.201	4.90	5.10
A1	.106	.114	2.70	2.90
A2	.075	.083	1.90	2.10
b	.047	.055	1.20	1.40
b1	.061	.069	1.55	1.75
b2	.087	.094	2.20	2.40
c	.020	.029	0.51	0.74
D	.819	.846	20.80	21.50
E	.768	.799	19.50	20.30
e	.150 BSC		3.81 BSC	
e1	.450 BSC		11.43 BSC	
L	.780	.838	19.80	21.30
L1	.083	.094	2.10	2.40
Q	.213	.236	5.40	6.00
R	.157	.169	4.00	4.30
S	.673	.685	17.10	17.40
T	.602	.614	15.30	15.60
U	.142	.154	3.60	3.90