



IXYS

A Littelfuse Technology

 Date: - 20th Dec 2019

Data Sheet Issue: - 4

IGBT Gate Driver Type C0044BG400

Special Features

- High reliability topology
- Separate gate interface card for optimal packaging
- Designed for ultra low power consumption
- Balanced supply current in ON and OFF mode
- Build in DC/DC-converter with soft start
- Integrated input filter for low EMI
- Separate low impedance path for parasitic EMI currents
- PD-Voltage levels available up to 7kV
- Low impedance from gate to emitter at start-up and power fail
- Monitoring of all secondary supply voltages
- Monitoring of IGBT switching status ($V_{CE-desat}$ detection)
- Soft switch-OFF at $V_{CE-desat}$ fault condition
- Fibre-optic links for switching commands and status control
- Low light protection for input signal
- Short-pulse suppression, configurable
- Balanced propagation delay time
- Gate Current up to 44A
- Optional gate-speed-up capacitors

Absolute Maximum Ratings

	Ratings	Maximum limits	Units
V_s	Supply voltage primary	18	V
$I_{out\ peak}$	Gate- ON current (theoretical)	44	A
$I_{in\ peak}$	Gate- OFF current (theoretical)	-68	A
I_{av}	Average gate current	>100 (tbd.)	mA
V_{pd}	Partial discharge voltage	min. 2.5 (up to 7 on request)	kV
dv/dt	Slew rate ⁴	tbd., >50	kV/ μ s
$R_{g\ on}$	minimal R_{on}	0.75	Ω
$R_{g\ off}$	minimal R_{off}	0.75	Ω
T_{op}	Operating temperature	-20 to +55	$^{\circ}$ C
T_{stg}	Storage temperature	-20 to +55	$^{\circ}$ C

Characteristics

	Parameter	min.	typ.	max.	Units
V _s	Supply voltage primary	14.4	15	15.6	V
I _{s0}	Supply current without load		70		mA
V _{gon}	Gate-On voltage	+11.5	+15	+15.8	V
V _{goff}	Gate-Off voltage	-15.8	-15	-11.5	V
V _{ce desat}	Collector-Emitter-threshold voltage	20	25		V
P _{WG +15}	Power Good Monitor +15V supply secondary		14.2		V
P _{WB +15}	Power Bad Signal +15V supply secondary		12.0		V
P _{WG +5}	Power Good Monitor +5V supply secondary		4.8		V
P _{WB +5}	Power Bad Signal +5V supply secondary		4.5		V
P _{WG -15}	Power Good Monitor -15V supply secondary		-13.7		V
P _{WB -15}	Power Bad Signal -15V supply secondary		-12.6		V
P _{WG +50}	Power Good Monitor +50V supply secondary		+44.5		V
P _{WB +50}	Power Bad Signal +50V supply secondary		+36.5		V
T _d	propagation-delay time (T _{on} =T _{off})		1.4		μs
T _s	Soft-switch-off time		30		μs
R _s	Passive short circuit gate resistor		20		kΩ
C _c	Coupling capacitance primary-secondary		16	20	pF
Burst susceptibility	Conducted noise immunity (burst)		>4		kV

Functional Description

Start up behavior

An un-powered gate driver applies impedance to the gate-emitter connection as follows:

- Permanent 20kΩ passive resistance (plus possible 20kΩ parallel on “IGBT Interface Board”)
- Low impedance by discharged supply capacitors and main amplifier freewheeling diodes.
- Separate MOSFET that clamps gate output to minus supply voltage as soon as the difference from positive supply to negative supply exceeds 3V during power up sequence until “Power Good” is valid.

This way the gate-emitter output is kept in OFF status during power up and power down sequence of the primary side driver supply. (See Figure 1)

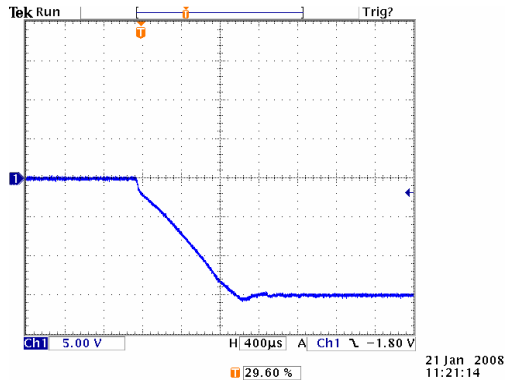

Figure 1: Typical start up sequence
Ch1: Gate voltage at power up condition

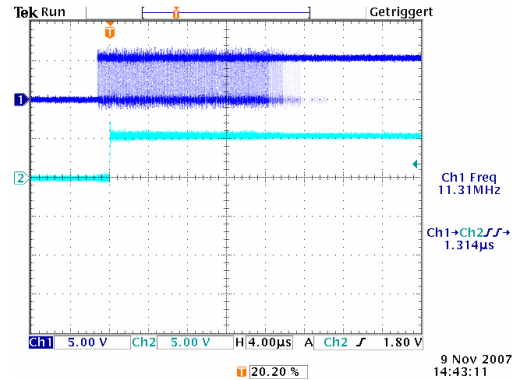

Fig 2: Internal PWM signal generation at the output of special circuit. Optical transmitter driven with sinusoidal current
Ch1: Weak PWM signal direct at optical receiver (RX) output
Ch2: Recovered PWM ON command (driver internal)

Short Pulse Suppression – Low Light Protection

The optical Receiver (RX) type “versatile Link family” HFBR-2521 (5M-Baud) is followed by a special circuit that not only ignores short ON or OFF commands, but also filters low light condition in order not to destroy driver or IGBT (within a t.b.d. range of the signal weakness). Propagation delay time for ON and OFF command is adjusted separately and well balanced to typical 1.4µsec at good optical signal quality. Depending on low light condition this delay may increase but will end up in one defined PWM command.

(See Figure .2)

Please note that all optical PWM commands will be symmetrically delayed by this circuit, expressed in the driver propagation delay time.

V_{CE-desat} Detection

The switching status of the IGBT is monitored by a current source. The V_{CE-desat} trip level is adjustable over a wide range and adjusted to 25V_{CE}, typically. Propagation delay OFF time is typically 0,3-0,5 µsec (depending on dv/dt of IGBT switching). The current source is designed to typ. 9 mA, trip level is set to < 6 mA. (Figures 3 and 4). A wide range of other levels/currents are available on request.

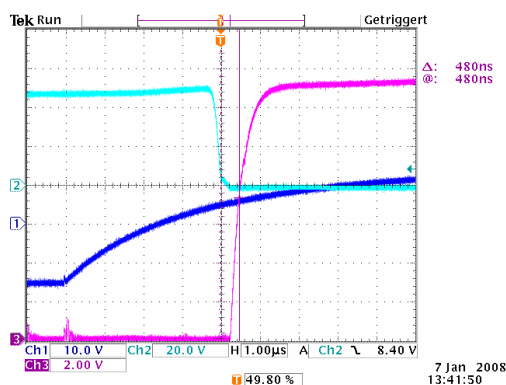

Figure 3: Switch ON command
Ch1: Gate voltage at 300nF simulated gate
Ch2: Collector- emitter voltage
Ch3: Internal V_{CE0} signal: Detection of IGBT ON status

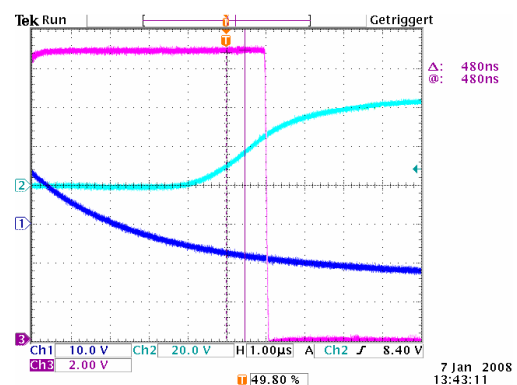

Figure 4: Switch OFF command
Ch1: Gate voltage at 300nF simulated gate
Ch2: Collector- emitter voltage
Ch3: Internal V_{CE0} signal: Detection of IGBT OFF status

Optical Feedback Signal, Error Management and Soft Turn OFF Timing

The optical feedback signal is a mix of a “real IGBT ON-echo” signal, power good condition and IGBT short circuit detection. It uses a transmitter (TX) type “versatile Link family” HFBR-1521 (5M-Baud).

With all secondary side supply voltages in “power good” status and no “ON command” at RX present, the feedback signal is illuminated with typical 35 mA.

If an ON command at RX occurs for longer than the short pulse suppression time the IGBT gate will be switched to ON status (after driver propagation delay ON time). As soon as the IGBT reacts correctly and its V_{CE} meets the trip level of 25V, the feedback signal will switch off TX light and act as a “real IGBT echo” (within propagation delay of the internal V_{CE0} signal).

If a PWM OFF command (longer than short pulse suppression OFF time) occurs at a $V_{CE} < 25$ V condition the IGBT gate is switched off with both (normal and soft turn OFF) amplifier paths regulated to -15 V. This is considered a normal/ fast turn OFF operation.

If V_{CE} never reaches the trip level or V_{CE} increases during an ON command above the trip level, the feedback signal reports a $V_{CE-desat}$ error by switching ON the TX light while a PWM ON command is present at RX.

Please note that this is a way for the user to detect a $V_{CE-desat}$ error monitored by the driver.

In this version of the driver family the driver does NOT turn OFF automatically. The PWM OFF command has to be generated by the user and the user has to take care of adequate guidelines to reach a tolerable OFF time delay. (Typical waiting time several μ sec, depending on IGBT type).

Any OFF user command at $V_{CE} > 25$ V will be executed by the soft turn OFF path only.

After a soft turn OFF time of typically 30 μ sec the IGBT should have switched successfully into a safe OFF status. After this soft turn OFF time the normal/ fast turn OFF path is enabled again, to provide low impedance OFF status at the gate like in nominal current turn OFF condition.

RX signal (PWM)	0	0	1	1	0	0	1	1
Power Good	0	0	0	0	1	1	1	1
$V_{CE} > 25$ V	0	1	0	1	0	1	0	1
TX signal (feedback)	0	0	0	0	1	1	0	1

Table 1: Logic State of Feedback TX/ RX Signal (1 = light ON)

Turn OFF Timing with and without Vce Trip

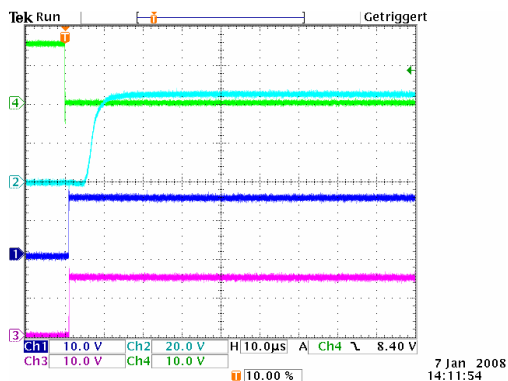

Figure 5: Switch OFF at normal operation (no VCE-desat trip)

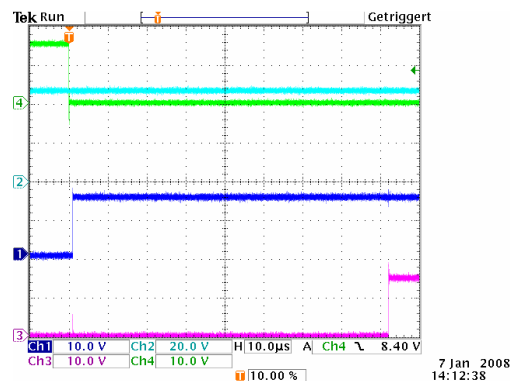

Figure 6: Switch OFF at VCE-desat trip

Ch1: Internal „Soft-OFF“enable command

Ch2: Collector-emitter voltage

Ch3: Internal „Fast-OFF“ command

(= low impedance OFF) state

Ch4: RX PWM light command

Please note: Soft turn OFF time was set to 81 μ sec here!

Under Voltage Error Management

This driver monitors all supply voltages generated on the secondary side with defined power good levels and a large hysteresis. Power good condition is given when desired voltage levels are nearly reached for the first time. Once power good is generated, it accepts a fairly low supply condition until the power good signal fails. Once power fail is detected the gate output is forced into IGBT OFF state and feedback signal TX will turn OFF normal/ fast.

Block Diagram

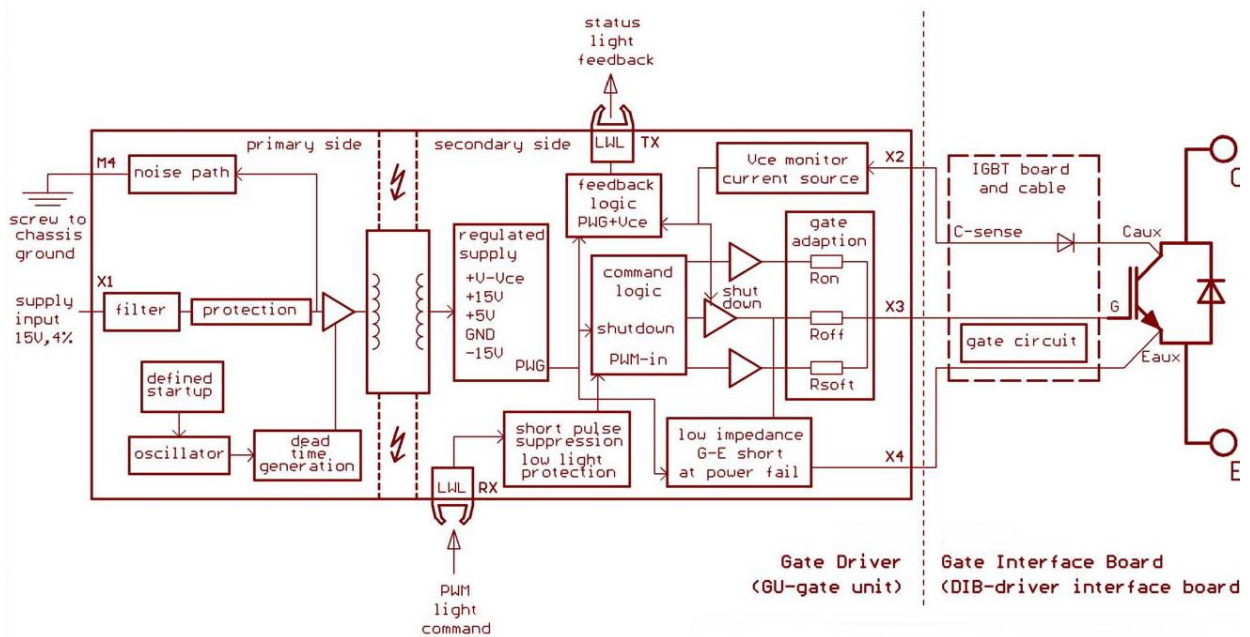

Customisation Code

Table 2 lists the customisation codes of gate drivers of different Westcode IGBT parts.

Customisation code of gate driver	IGBT Type	Customisation code of gate driver	IGBT Type
C0044BG400SCB	T0600NC17A	C0044BG400SBK	T0160NB45A
C0044BG400SCA	T0840NC17E	C0044BG400SBL	T0240NB45E
C0044BG400SCC	T0960VC17G	C0044BG400SBQ	T0340VB45G
C0044BG400SCD	T1440VC17E	C0044BG400SBE	T0510VB45E
C0044BG400SCE	T1680TC17G	C0044BG400SBM	T0600TB45A
C0044BG400SCF	T0140QC33G	C0044BG400SBG	T0800EB45G
C0044BG400SCG	T0285NC33E	C0044BG400SBN	T0800TB45E
C0044BG400SCH	T0425VC33G	C0044BG400SBP	T0900EB45A
C0044BG400SCJ	T0640VC33E	C0044BG400SBR	T1200EB45E
C0044BG400SCK	T0710TC33A	C0044BG400SBJ	T1600GB45G
C0044BG400SCM	T1000EC33G	C0044BG400SBS	T1800GB45A
C0044BG400SCL	T1000TC33E	C0044BG400SBZ	T2000BB45G
C0044BG400SCN	T1500EC33E	C0044BG400SBT	T2400GB45E
C0044BG400SBX	T0115QB45G	C0044BG400SBW	T2960BB45E

Table 2: Customisation code of gate driver

Outline Drawing & Ordering Information

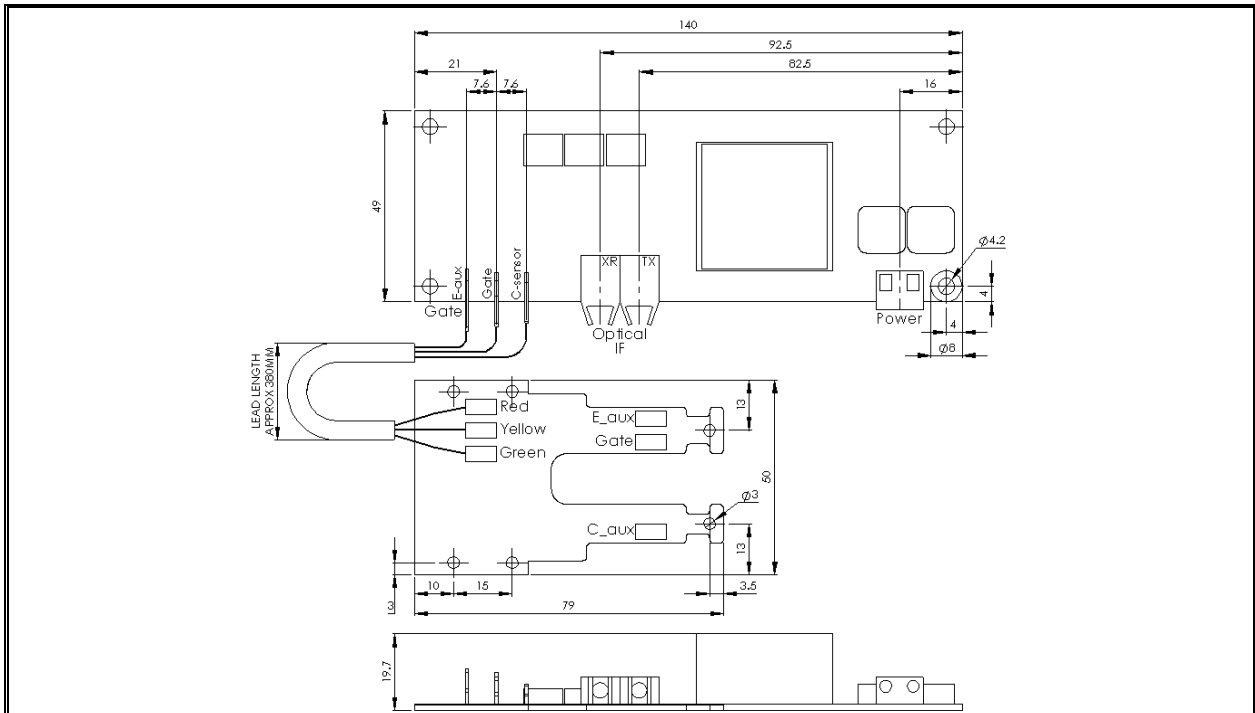

Dimensions (in mm) and position of connectors of the C0044BG400
 Creep distances on PCB from primary to secondary side > 30 mm. (>35mm on request)
 Creep distances from PCB mounting holes to PCB circuit: none (zero mm), use of isolated spacers is recommended!

ORDERING INFORMATION

(Please quote 13 digit code as below)

C0044	B	G	40	0	S##
Fixed Type Code	Fixed Board Type Code	Fixed Circuit Type Code	Fixed Voltage Code $V_{PD} \div 100$	Fixed Code	Customisation code (see table 2)

Typical order code:: C0044BG400SBT – C0044BG400 GDU for use with T2400GB45E IGBT

IXYS Semiconductor GmbH
 Edisonstraße 15
 D-68623 Lampertheim
 Tel: +49 6206 503-0
 Fax: +49 6206 503-627
 E-mail: marcom@ixys.de



IXYS
 A Littelfuse Technology

IXYS UK Westcode Ltd
 Langley Park Way, Langley Park,
 Chippenham, Wiltshire, SN15 1GE.
 Tel: +44 (0)1249 444524
 E-mail: sales@ixysuk.com

IXYS Corporation
 1590 Buckeye Drive
 Milpitas CA 95035 7418 USA
 Tel: +1 (408) 547 9000
 Fax: +1 (408) 496 0670
 E-mail: sales@ixys.net

www.littelfuse.com

www.ixysuk.com

www.ixys.com

IXYS Long beach Inc
 2500 Mira Mar Avenue
 Long Beach CA 90815 USA
 Tel: +1 (562) 296 6584
 Fax: +1 (562) 296 6585
 E-mail: service@ixyslongbeach.com

The information contained herein is confidential and is protected by Copyright. The information may not be used or disclosed except with the written permission of and in the manner permitted by the proprietors IXYS UK Westcode Ltd.

© IXYS UK Westcode Ltd.

In the interest of product improvement, IXYS UK Westcode Ltd reserves the right to change specifications at any time without prior notice.

Devices with a suffix code (2-letter, 3-letter or letter/digit/letter combination) added to their generic code are not necessarily subject to the conditions and limits contained in this report.



Disclaimer Notice - Information furnished is believed to be accurate and reliable. However, users should independently evaluate the suitability of and test each product selected for their own applications. Littelfuse products are not designed for, and may not be used in, all applications. Read complete Disclaimer Notice at www.littelfuse.com/disclaimer-electronics.