

 Date: - 20<sup>th</sup> Dec 2019

Data Sheet Issue: - 4

# IGBT Gate Driver Type C0044BG400

## Special Features

- High reliability topology
- Separate gate interface card for optimal packaging
- Designed for ultra low power consumption
- Balanced supply current in ON and OFF mode
- Build in DC/DC-converter with soft start
- Integrated input filter for low EMI
- Separate low impedance path for parasitic EMI currents
- PD-Voltage levels available up to 7kV
- Low impedance from gate to emitter at start-up and power fail
- Monitoring of all secondary supply voltages
- Monitoring of IGBT switching status ( $V_{CE-desat}$  detection)
- Soft switch-OFF at  $V_{CE-desat}$  fault condition
- Fibre-optic links for switching commands and status control
- Low light protection for input signal
- Short-pulse suppression, configurable
- Balanced propagation delay time
- Gate Current up to 44A
- Optional gate-speed-up capacitors

## Absolute Maximum Ratings

|                 | Ratings                         | Maximum limits                | Units        |
|-----------------|---------------------------------|-------------------------------|--------------|
| $V_s$           | Supply voltage primary          | 18                            | V            |
| $I_{out\ peak}$ | Gate- ON current (theoretical)  | 44                            | A            |
| $I_{in\ peak}$  | Gate- OFF current (theoretical) | -68                           | A            |
| $I_{av}$        | Average gate current            | >100 (tbd.)                   | mA           |
| $V_{pd}$        | Partial discharge voltage       | min. 2.5 (up to 7 on request) | kV           |
| $dv/dt$         | Slew rate <sup>4</sup>          | tbd., >50                     | kV/ $\mu$ s  |
| $R_{g\ on}$     | minimal $R_{on}$                | 0.75                          | $\Omega$     |
| $R_{g\ off}$    | minimal $R_{off}$               | 0.75                          | $\Omega$     |
| $T_{op}$        | Operating temperature           | -20 to +55                    | $^{\circ}$ C |
| $T_{stg}$       | Storage temperature             | -20 to +55                    | $^{\circ}$ C |

## Characteristics

|                       | Parameter   | min.  | typ.  | max.  | Units |
|-----------------------|---|-------|-------|-------|-------|
| V <sub>s</sub>        | Supply voltage primary                                      | 14.4  | 15    | 15.6  | V     |
| I <sub>s0</sub>       | Supply current without load                                 |       | 70    |       | mA    |
| V <sub>gon</sub>      | Gate-On voltage   | +11.5 | +15   | +15.8 | V     |
| V <sub>goff</sub>     | Gate-Off voltage  | -15.8 | -15   | -11.5 | V     |
| V <sub>ce desat</sub> | Collector-Emitter-threshold voltage                         | 20    | 25    |       | V     |
| P <sub>WG +15</sub>   | Power Good Monitor +15V supply secondary                    |       | 14.2  |       | V     |
| P <sub>WB +15</sub>   | Power Bad Signal +15V supply secondary                      |       | 12.0  |       | V     |
| P <sub>WG +5</sub>    | Power Good Monitor +5V supply secondary                     |       | 4.8   |       | V     |
| P <sub>WB +5</sub>    | Power Bad Signal +5V supply secondary                       |       | 4.5   |       | V     |
| P <sub>WG -15</sub>   | Power Good Monitor -15V supply secondary                    |       | -13.7 |       | V     |
| P <sub>WB -15</sub>   | Power Bad Signal -15V supply secondary                      |       | -12.6 |       | V     |
| P <sub>WG +50</sub>   | Power Good Monitor +50V supply secondary                    |       | +44.5 |       | V     |
| P <sub>WB +50</sub>   | Power Bad Signal +50V supply secondary                      |       | +36.5 |       | V     |
| T <sub>d</sub>        | propagation-delay time (T <sub>on</sub> =T <sub>off</sub> ) |       | 1.4   |       | μs    |
| T <sub>s</sub>        | Soft-switch-off time  |       | 30    |       | μs    |
| R <sub>s</sub>        | Passive short circuit gate resistor                         |       | 20    |       | kΩ    |
| C <sub>c</sub>        | Coupling capacitance primary-secondary                      |       | 16    | 20    | pF    |
| Burst susceptibility  | Conducted noise immunity (burst)                            |       | >4    |       | kV    |

## Functional Description

### Start up behavior

An un-powered gate driver applies impedance to the gate-emitter connection as follows:

- Permanent 20kΩ passive resistance (plus possible 20kΩ parallel on “IGBT Interface Board”)
- Low impedance by discharged supply capacitors and main amplifier freewheeling diodes.
- Separate MOSFET that clamps gate output to minus supply voltage as soon as the difference from positive supply to negative supply exceeds 3V during power up sequence until “Power Good” is valid.

This way the gate-emitter output is kept in OFF status during power up and power down sequence of the primary side driver supply. (See Figure 1)

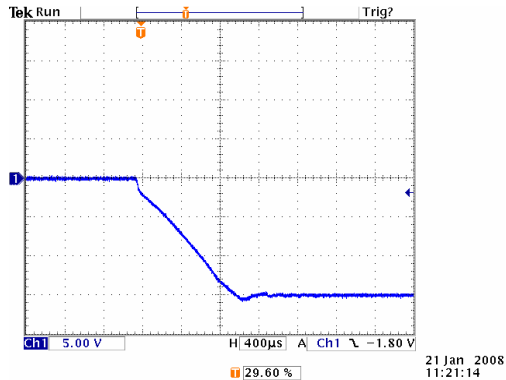

**Figure 1: Typical start up sequence**  
Ch1: Gate voltage at power up condition

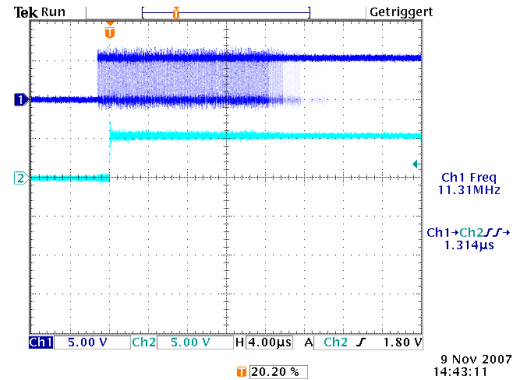

**Fig 2: Internal PWM signal generation at the output of special circuit. Optical transmitter driven with sinusoidal current**  
Ch1: Weak PWM signal direct at optical receiver (RX) output  
Ch2: Recovered PWM ON command (driver internal)

### Short Pulse Suppression – Low Light Protection

The optical Receiver (RX) type “versatile Link family” HFBR-2521 (5M-Baud) is followed by a special circuit that not only ignores short ON or OFF commands, but also filters low light condition in order not to destroy driver or IGBT (within a t.b.d. range of the signal weakness). Propagation delay time for ON and OFF command is adjusted separately and well balanced to typical 1.4µsec at good optical signal quality. Depending on low light condition this delay may increase but will end up in one defined PWM command.

(See Figure .2)

**Please note** that all optical PWM commands will be symmetrically delayed by this circuit, expressed in the driver propagation delay time.

### V<sub>CE-desat</sub> Detection

The switching status of the IGBT is monitored by a current source. The V<sub>CE-desat</sub> trip level is adjustable over a wide range and adjusted to 25V<sub>CE</sub>, typically. Propagation delay OFF time is typically 0,3-0,5 µsec (depending on dv/dt of IGBT switching). The current source is designed to typ. 9 mA, trip level is set to < 6 mA. (Figures 3 and 4). A wide range of other levels/currents are available on request.

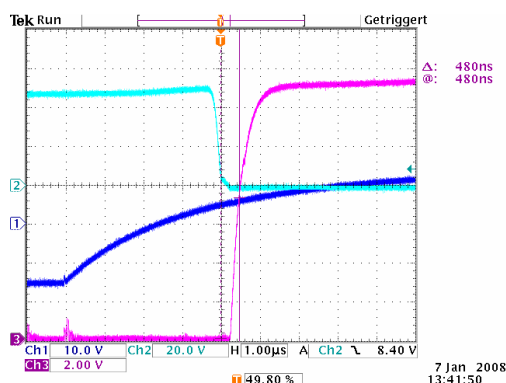

**Figure 3: Switch ON command**  
Ch1: Gate voltage at 300nF simulated gate  
Ch2: Collector- emitter voltage  
Ch3: Internal V<sub>CE0</sub> signal: Detection of IGBT ON status

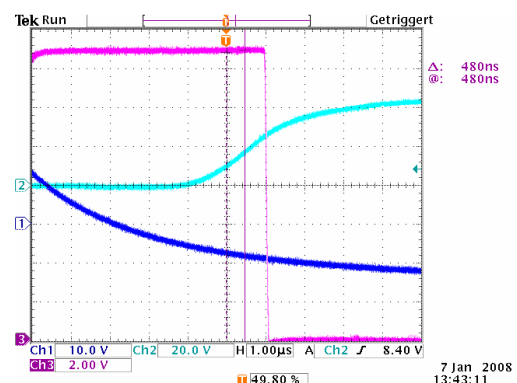

**Figure 4: Switch OFF command**  
Ch1: Gate voltage at 300nF simulated gate  
Ch2: Collector- emitter voltage  
Ch3: Internal V<sub>CE0</sub> signal: Detection of IGBT OFF status

### Optical Feedback Signal, Error Management and Soft Turn OFF Timing

The optical feedback signal is a mix of a “real IGBT ON-echo” signal, power good condition and IGBT short circuit detection. It uses a transmitter (TX) type “versatile Link family” HFBR-1521 (5M-Baud).

With all secondary side supply voltages in “power good” status and no “ON command” at RX present, the feedback signal is illuminated with typical 35 mA.

If an ON command at RX occurs for longer than the short pulse suppression time the IGBT gate will be switched to ON status (after driver propagation delay ON time). As soon as the IGBT reacts correctly and its  $V_{CE}$  meets the trip level of 25V, the feedback signal will switch off TX light and act as a “real IGBT echo” (within propagation delay of the internal  $V_{CE0}$  signal).

If a PWM OFF command (longer than short pulse suppression OFF time) occurs at a  $V_{CE} < 25V$  condition the IGBT gate is switched off with both (normal and soft turn OFF) amplifier paths regulated to -15 V. This is considered a normal/ fast turn OFF operation.

If  $V_{CE}$  never reaches the trip level or  $V_{CE}$  increases during an ON command above the trip level, the feedback signal reports a  $V_{CE-desat}$  error by switching ON the TX light while a PWM ON command is present at RX.

**Please note** that this is a way for the user to detect a  $V_{CE-desat}$  error monitored by the driver.

**In this version of the driver family the driver does NOT turn OFF automatically. The PWM OFF command has to be generated by the user** and the user has to take care of adequate guidelines to reach a tolerable OFF time delay. (Typical waiting time several  $\mu\text{sec}$ , depending on IGBT type).

**Any OFF user command at  $V_{CE} > 25V$  will be executed by the soft turn OFF path only.**

After a soft turn OFF time of typically 30  $\mu\text{sec}$  the IGBT should have switched successfully into a safe OFF status. After this soft turn OFF time the normal/ fast turn OFF path is enabled again, to provide low impedance OFF status at the gate like in nominal current turn OFF condition.

|                      |   |   |   |   |   |   |   |   |
|----------------------|---|---|---|---|---|---|---|---|
| RX signal (PWM)      | 0 | 0 | 1 | 1 | 0 | 0 | 1 | 1 |
| Power Good           | 0 | 0 | 0 | 0 | 1 | 1 | 1 | 1 |
| $V_{CE} > 25V$       | 0 | 1 | 0 | 1 | 0 | 1 | 0 | 1 |
| TX signal (feedback) | 0 | 0 | 0 | 0 | 1 | 1 | 0 | 1 |

Table 1: Logic State of Feedback TX/ RX Signal (1 = light ON)

### Turn OFF Timing with and without Vce Trip

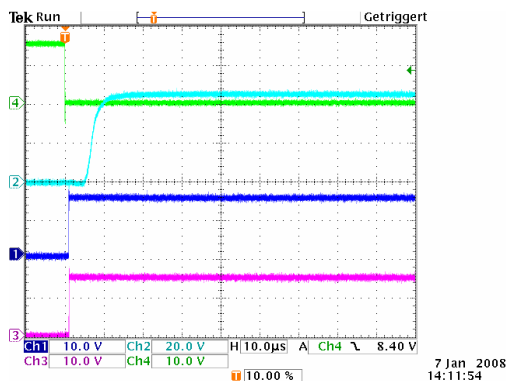

Figure 5: Switch OFF at normal operation (no VCE-desat trip)

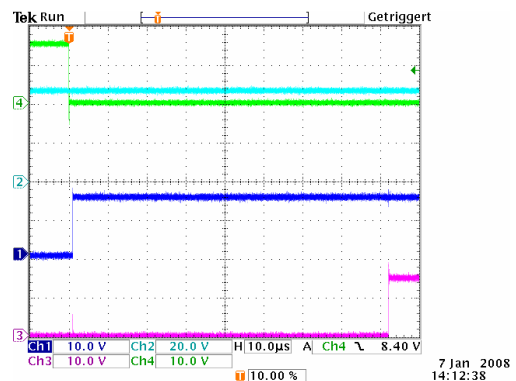

Figure 6: Switch OFF at VCE-desat trip

Ch1: Internal „Soft-OFF“enable command  
 Ch2: Collector-emitter voltage  
 Ch3: Internal „Fast-OFF“ command

(= low impedance OFF) state  
 Ch4: RX PWM light command

**Please note: Soft turn OFF time was set to 81  $\mu\text{sec}$  here!**

### Under Voltage Error Management

This driver monitors all supply voltages generated on the secondary side with defined power good levels and a large hysteresis. Power good condition is given when desired voltage levels are nearly reached for the first time. Once power good is generated, it accepts a fairly low supply condition until the power good signal fails. Once power fail is detected the gate output is forced into IGBT OFF state and feedback signal TX will turn OFF normal/ fast.

## Block Diagram

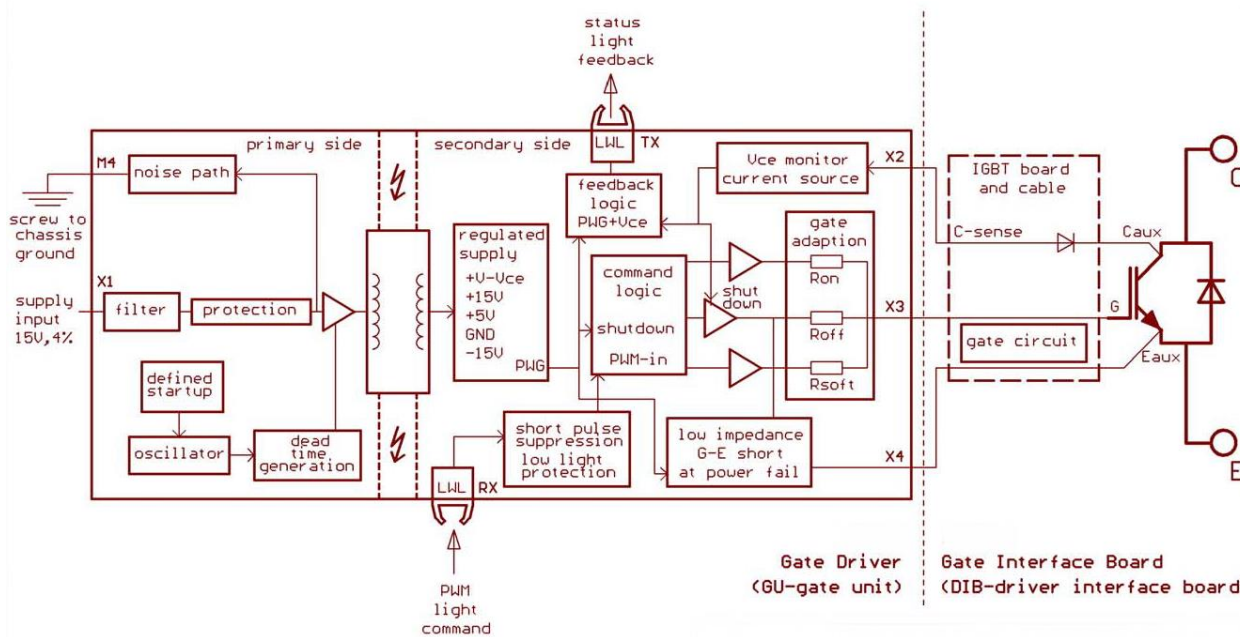

## Customisation Code

Table 2 lists the customisation codes of gate drivers of different Westcode IGBT parts.

| Customisation code of gate driver | IGBT Type  | Customisation code of gate driver | IGBT Type  |
|-----------------------------------|------------|-----------------------------------|------------|
| <b>C0044BG400SCB</b>              | T0600NC17A | <b>C0044BG400SBK</b>              | T0160NB45A |
| <b>C0044BG400SCA</b>              | T0840NC17E | <b>C0044BG400SBL</b>              | T0240NB45E |
| <b>C0044BG400SCC</b>              | T0960VC17G | <b>C0044BG400SBQ</b>              | T0340VB45G |
| <b>C0044BG400SCD</b>              | T1440VC17E | <b>C0044BG400SBE</b>              | T0510VB45E |
| <b>C0044BG400SCE</b>              | T1680TC17G | <b>C0044BG400SBM</b>              | T0600TB45A |
| <b>C0044BG400SCF</b>              | T0140QC33G | <b>C0044BG400SBG</b>              | T0800EB45G |
| <b>C0044BG400SCG</b>              | T0285NC33E | <b>C0044BG400SBN</b>              | T0800TB45E |
| <b>C0044BG400SCH</b>              | T0425VC33G | <b>C0044BG400SBP</b>              | T0900EB45A |
| <b>C0044BG400SCJ</b>              | T0640VC33E | <b>C0044BG400SBR</b>              | T1200EB45E |
| <b>C0044BG400SCK</b>              | T0710TC33A | <b>C0044BG400SBJ</b>              | T1600GB45G |
| <b>C0044BG400SCM</b>              | T1000EC33G | <b>C0044BG400SBS</b>              | T1800GB45A |
| <b>C0044BG400SCL</b>              | T1000TC33E | <b>C0044BG400SBZ</b>              | T2000BB45G |
| <b>C0044BG400SCN</b>              | T1500EC33E | <b>C0044BG400SBT</b>              | T2400GB45E |
| <b>C0044BG400SBX</b>              | T0115QB45G | <b>C0044BG400SBW</b>              | T2960BB45E |

Table 2: Customisation code of gate driver

## Outline Drawing & Ordering Information

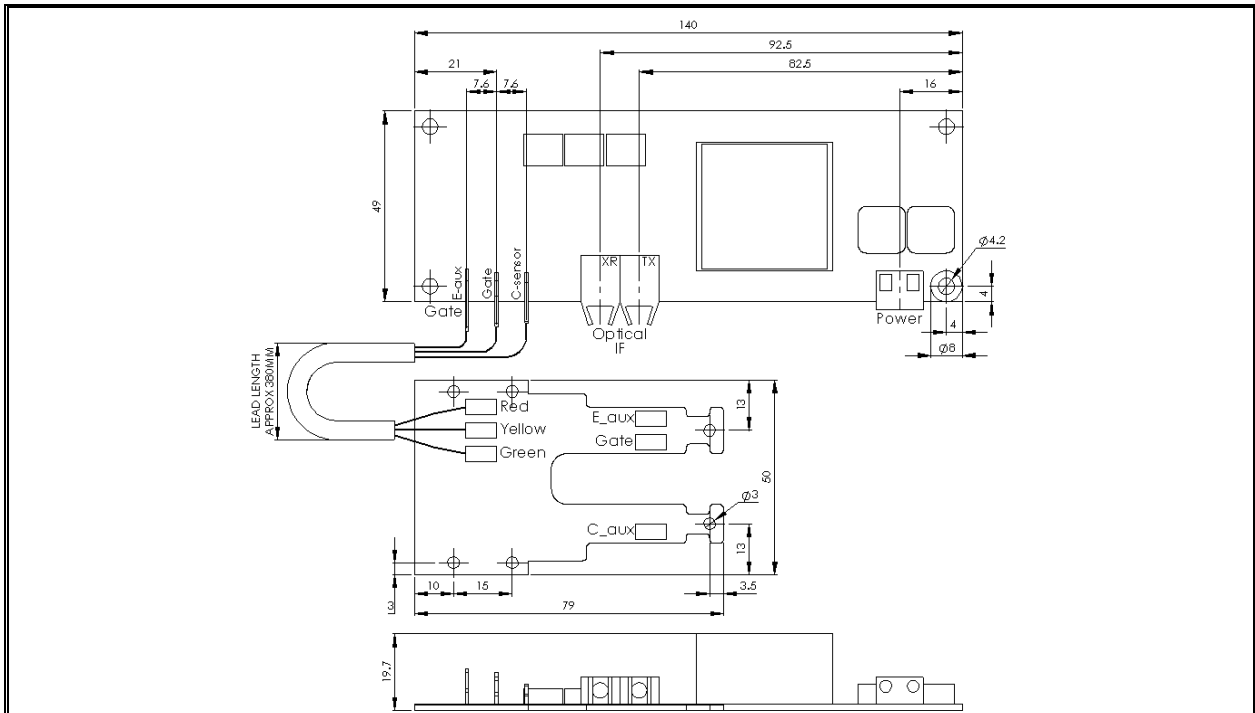

Dimensions (in mm) and position of connectors of the C0044BG400

Creep distances on PCB from primary to secondary side > 30 mm. (>35mm on request)

Creep distances from PCB mounting holes to PCB circuit: none (zero mm), use of isolated spacers is recommended!

### ORDERING INFORMATION

(Please quote 13 digit code as below)

| <b>C0044</b>    | <b>B</b>              | <b>G</b>                | <b>40</b>                               | <b>0</b>   | <b>S##</b>                          |
|-----------------|-----------------------|-------------------------|---|------------|-------------------------------------|
| Fixed Type Code | Fixed Board Type Code | Fixed Circuit Type Code | Fixed Voltage Code<br>$V_{PD} \div 100$ | Fixed Code | Customisation code<br>(see table 2) |

Typical order code:: C0044BG400SBT – C0044BG400 GDU for use with T2400GB45E IGBT

**IXYS Semiconductor GmbH**  
 Edisonstraße 15  
 D-68623 Lampertheim  
 Tel: +49 6206 503-0  
 Fax: +49 6206 503-627  
 E-mail: [marcom@ixys.de](mailto:marcom@ixys.de)



**IXYS**  
 A Littelfuse Technology

**IXYS UK Westcode Ltd**  
 Langley Park Way, Langley Park,  
 Chippenham, Wiltshire, SN15 1GE.  
 Tel: +44 (0)1249 444524  
 E-mail: [sales@ixysuk.com](mailto:sales@ixysuk.com)

**IXYS Corporation**  
 1590 Buckeye Drive  
 Milpitas CA 95035 7418 USA  
 Tel: +1 (408) 547 9000  
 Fax: +1 (408) 496 0670  
 E-mail: [sales@ixys.net](mailto:sales@ixys.net)

[www.littelfuse.com](http://www.littelfuse.com)

[www.ixysuk.com](http://www.ixysuk.com)

[www.ixys.com](http://www.ixys.com)

**IXYS Long beach Inc**  
 2500 Mira Mar Avenue  
 Long Beach CA 90815 USA  
 Tel: +1 (562) 296 6584  
 Fax: +1 (562) 296 6585  
 E-mail: [service@ixyslongbeach.com](mailto:service@ixyslongbeach.com)

The information contained herein is confidential and is protected by Copyright. The information may not be used or disclosed except with the written permission of and in the manner permitted by the proprietors IXYS UK Westcode Ltd.

© IXYS UK Westcode Ltd.

In the interest of product improvement, IXYS UK Westcode Ltd reserves the right to change specifications at any time without prior notice.

Devices with a suffix code (2-letter, 3-letter or letter/digit/letter combination) added to their generic code are not necessarily subject to the conditions and limits contained in this report.



Disclaimer Notice - Information furnished is believed to be accurate and reliable. However, users should independently evaluate the suitability of and test each product selected for their own applications. Littelfuse products are not designed for, and may not be used in, all applications. Read complete Disclaimer Notice at [www.littelfuse.com/disclaimer-electronics](http://www.littelfuse.com/disclaimer-electronics).