

Advance data

Insulated Gate Bi-Polar Transistor

Type T1290BF65A

Absolute Maximum Ratings

	VOLTAGE RATINGS	MAXIMUM LIMITS	UNITS
V _{CES}	Collector – emitter voltage	6500	V
V _{CES}	Collector – emitter voltage (T _j 25°C)	6500	V
V _{CES}	Collector – emitter voltage (T _j -40°C)	6000	V
V _{DC link}	Permanent DC voltage for 100 FIT failure rate.	3600	V
V _{GES}	Peak gate – emitter voltage	±20	V

	RATINGS	MAXIMUM LIMITS	UNITS
I _C	DC collector current, IGBT	1290	A
I _{CRM}	Repetitive peak collector current, t _p =1ms, IGBT	2580	A
I _{F(DC)}	Continuous DC forward current, Diode	1290	A
I _{FRM}	Repetitive peak forward current, t _p =1ms, Diode	2580	A
I _{FSM}	Peak non-repetitive surge t _p =10ms, V _{RM} =60%V _{RRM} , Diode (Note 4)	10.9	kA
I _{FSM2}	Peak non-repetitive surge t _p =10ms, V _{RM} ≤10V, Diode (Note 4)	12	kA
P _{MAX}	Maximum power dissipation, IGBT (Note 2)	15.2	KW
(di/dt) _{cr}	Critical diode di/dt (note 3)	4500	A/μs
T _j	Operating temperature range.	-40 to +125	°C
T _{stg}	Storage temperature range.	-40 to +125	°C

Notes: -

- 1) Unless otherwise indicated T_j = 125°C.
- 2) T_{sink} = 25°C, double side cooled.
- 3) Maximum commutation loop inductance 230nH.
- 4) Half-sinewave, 125°C T_j initial.

Characteristics

IGBT Characteristics

	PARAMETER	MIN	TYP	MAX	TEST CONDITIONS	UNITS
V _{CE(sat)}	Collector – emitter saturation voltage	-	3.6	4.0	I _C = 1290A, V _{GE} = 15V, T _j = 25°C	V
		-	4.8	5.2	I _C = 1290A, V _{GE} = 15V	V
V _{T0}	Threshold voltage	-		2.48	Current range: 430A – 1290A	V
r _T	Slope resistance	-		2.11		mΩ
V _{GE(TH)}	Gate threshold voltage	-	5.4	-	V _{CE} = V _{GE} , I _C = 800mA	V
I _{CES}	Collector – emitter cut-off current	-	12	45	V _{CE} = V _{CES} , V _{GE} = 0V	mA
I _{GES}	Gate leakage current	-40	-	+40	V _{GE} = ±20V	µA
C _{ies}	Input capacitance	-	225	-	V _{CE} = 10V, V _{GE} = 0V, f = 100kHz, T _j =25°C	nF
t _{d(on)}	Turn-on delay time	-	1.9	-	I _C = 1290A, V _{CE} = 3600V, di/dt = 3500A/µs V _{GE} = ±15V, L _S = 230nH R _{g(ON)} = 2.4Ω, R _{g(OFF)} = 7.5Ω, C _{GE} = 100nF Integral diode used as freewheel diode (Note 3)	µs
t _{r(V)}	Rise time	-	2.8	-		µs
Q _{g(on)}	Turn-on gate charge	-	7.5	-		µC
E _{on}	Turn-on energy	-	9	-		J
t _{d(off)}	Turn-off delay time	-	4.2	-		µs
t _{f(l)}	Fall time	-	2.2	-		µs
Q _{g(off)}	Turn-off gate charge	-	8	-		µC
E _{off}	Turn-off energy	-	7.3	-		J
I _{SC}	Short circuit current	-	7000	-		V _{GE} = +15V, V _{CC} = 3600V, V _{CEmax} ≤ V _{CES} , t _p ≤ 10µs

Diode Characteristics

	PARAMETER	MIN	TYP	MAX	TEST CONDITIONS	UNITS
V _F	Forward voltage	-	3.2	3.6	I _F = 1290A, T _j = 25°C	V
		-	3.6	4.0	I _F = 1290A	V
V _{To}	Threshold voltage	-	-	1.56	Current range 430A – 1290A	V
r _T	Slope resistance	-	-	1.58		mΩ
I _{rm}	Peak reverse recovery current	-	1400	-	V _i = 3600V, I _F = 1290A, V _{GE} = -15V, di/dt = 3500A/µs	A
Q _{rr}	Recovered charge	-	1900	-		µC
t _{rr}	Reverse recovery time, 50% chord	-	1.1	-		µs
E _r	Reverse recovery energy	-	2.8	-		J

Thermal Characteristics

	PARAMETER	MIN	TYP	MAX	TEST CONDITIONS	UNITS
R _{thJK}	Thermal resistance junction to sink, IGBT	-	-	6.56	Double side cooled	K/kW
		-	-	9.9	Collector side cooled	K/kW
		-	-	19.5	Emitter side cooled	K/kW
R _{thJK}	Thermal resistance junction to sink, Diode	-	-	12.2	Double side cooled	K/kW
		-	-	17.6	Cathode side cooled	K/kW
		-	-	39.3	Anode side cooled	K/kW
F	Mounting force	55	-	75	Note 2	kN
W _t	Weight	-	3.2	-		g

Notes:-

- 1) Unless otherwise indicated T_j = 125°C.
- 2) Consult application note 2008AN01 for detailed mounting requirements
- 3) C_{GE} is additional gate – emitter capacitance added to output of gate drive

Curves

Figure 1 – Typical collector-emitter saturation voltage characteristics

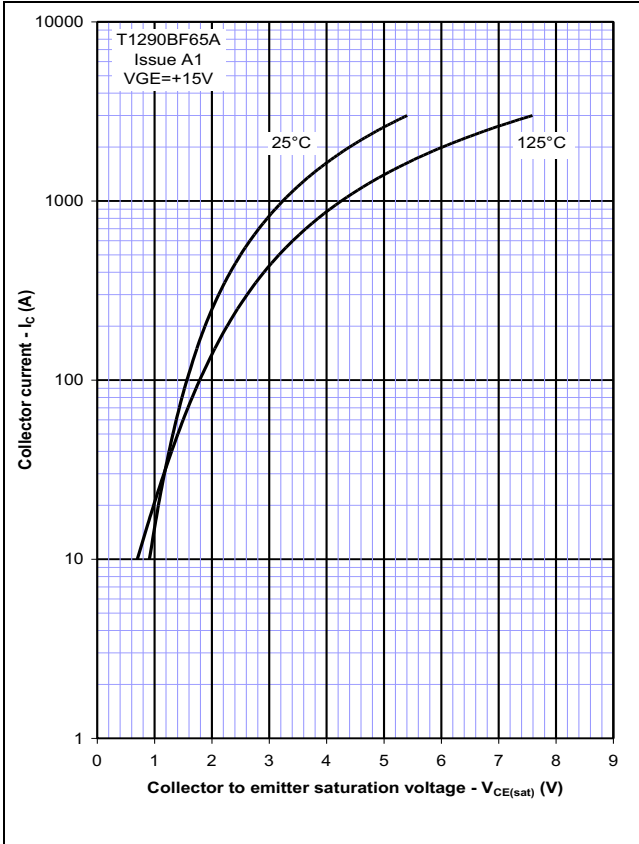

Figure 2 – Typical output characteristic

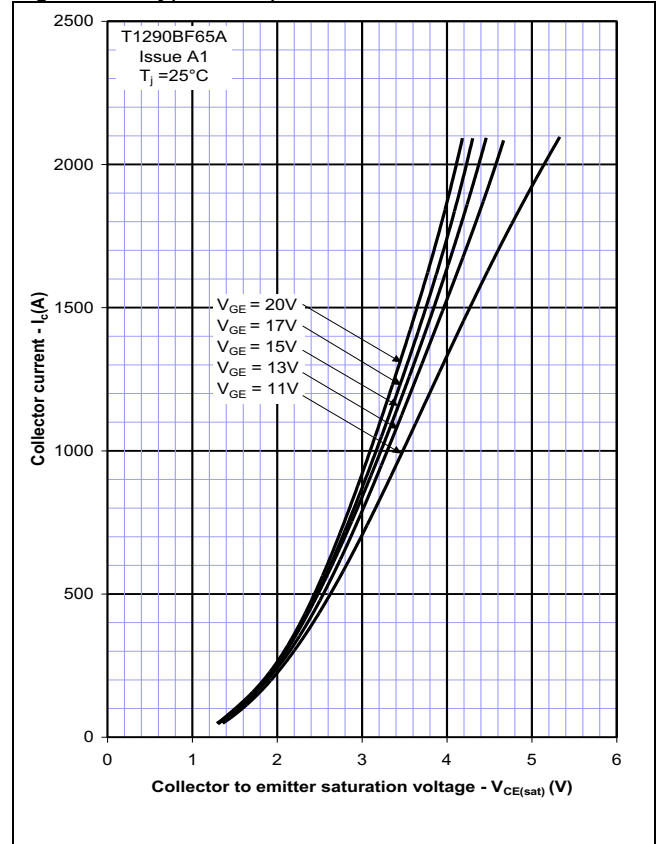

Figure 3 – Typical output characteristic

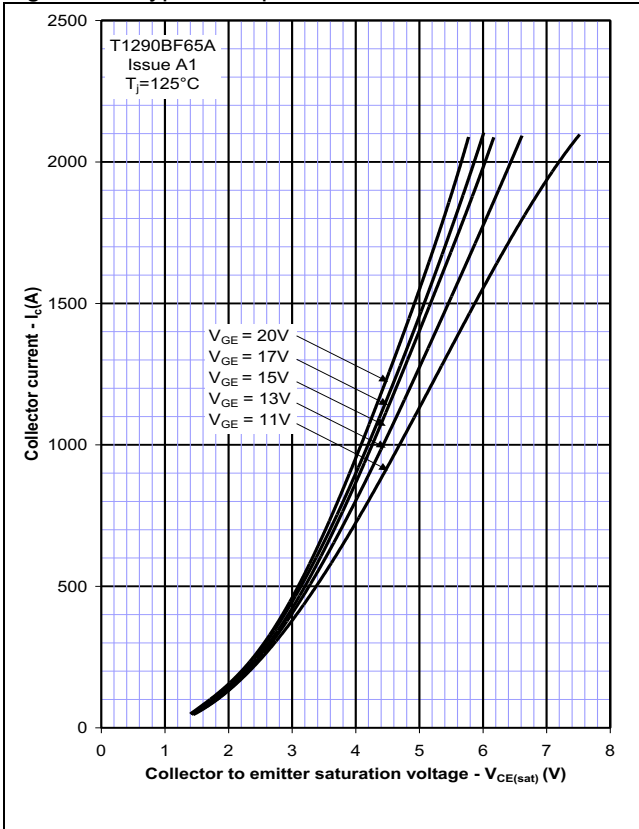

Figure 4 – Safe operating area (IGBT)

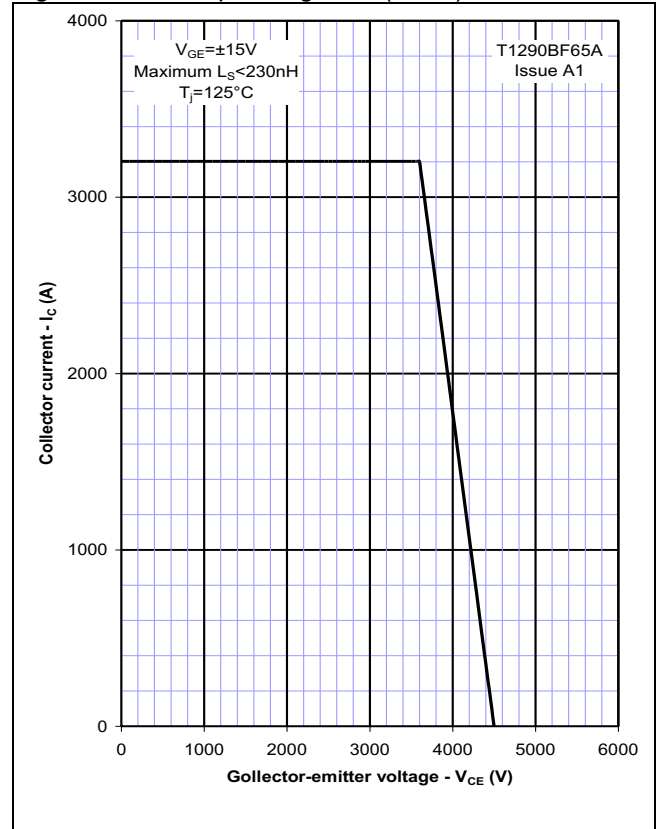

Figure 5 – Typical diode forward characteristics

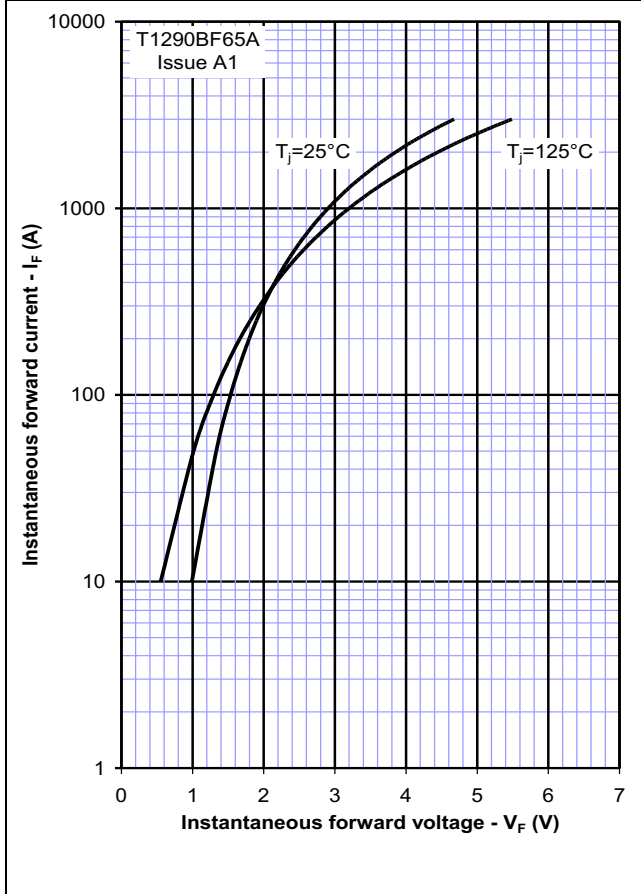

Figure 6 – Safe operating area (Diode)

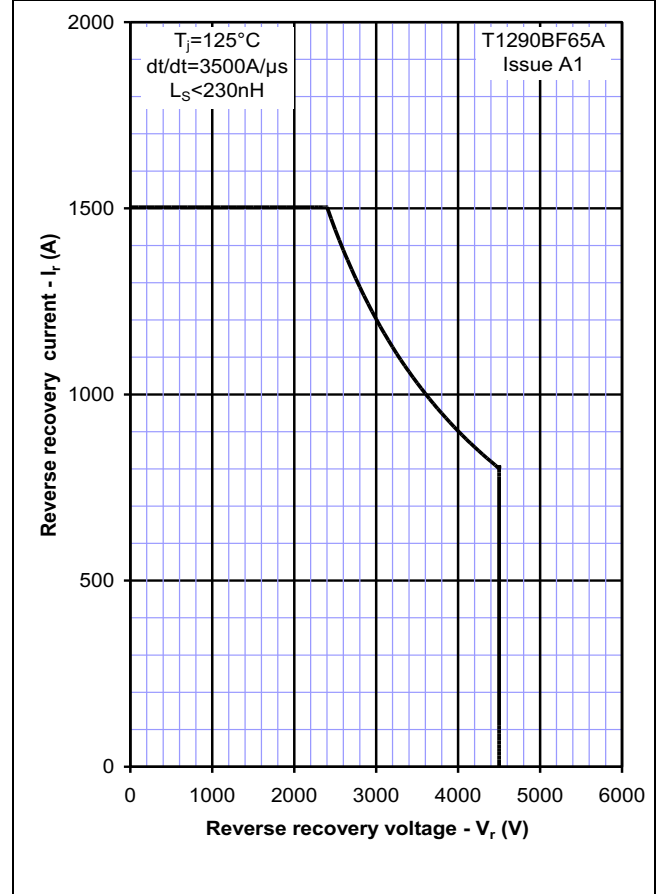

Figure 7 – Transient thermal impedance (IGBT)

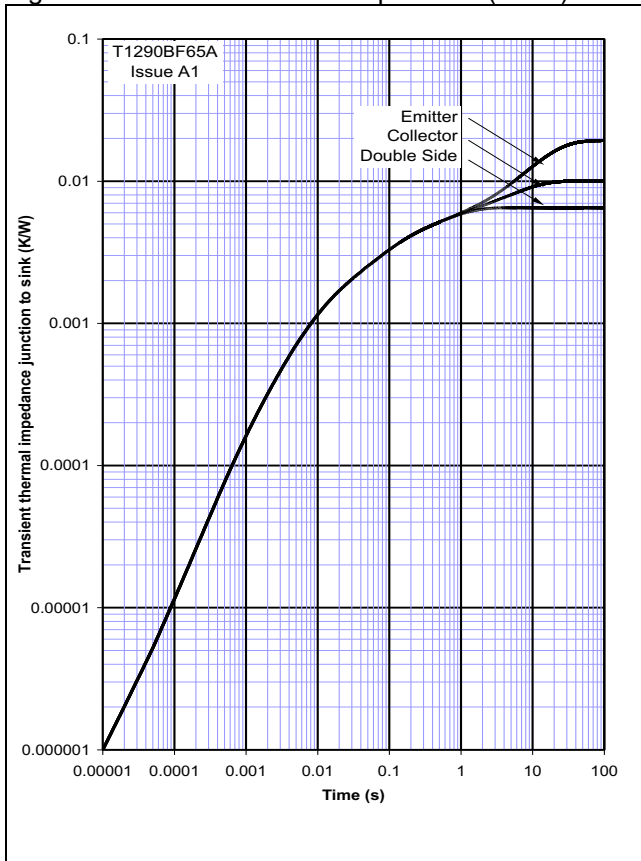
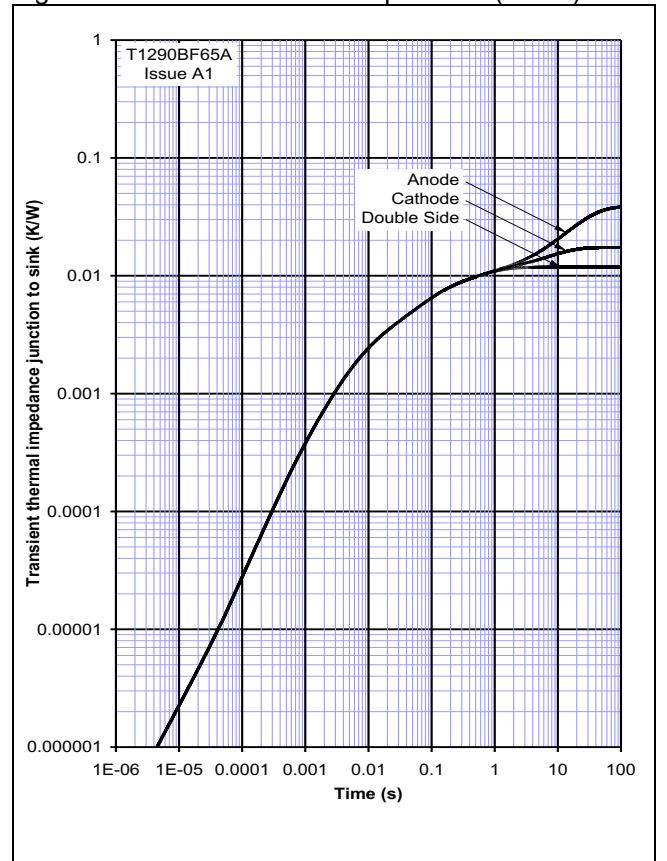
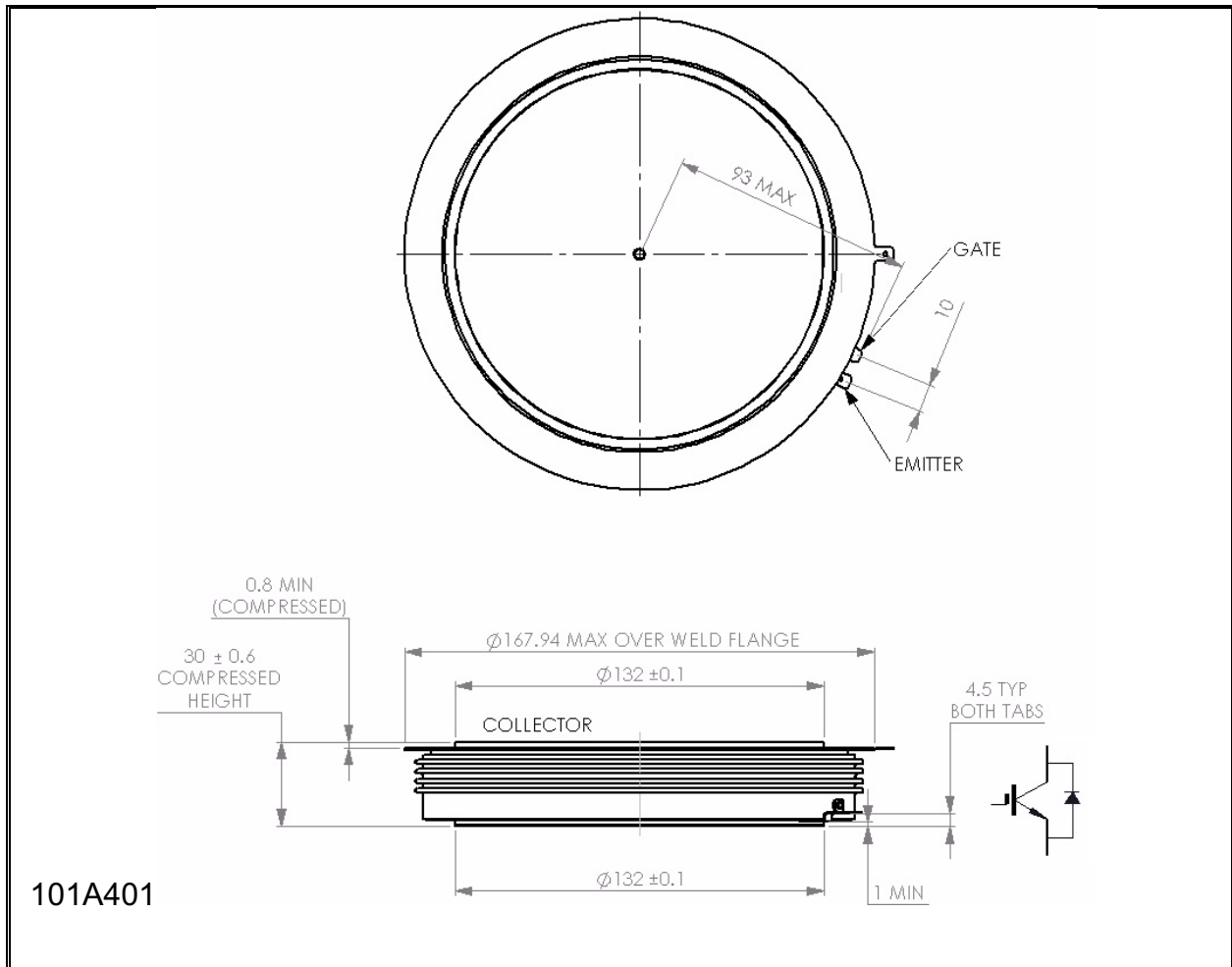

Figure 8 – Transient thermal impedance (Diode)



Outline Drawing & Ordering Information



ORDERING INFORMATION

(Please quote 10 digit code as below)

T1290	BF	65	A
Fixed type Code	Fixed Outline Code	Voltage Grade V _{CES} /100 65	Fixed format code

Typical order code: T1290BF65A (V_{CES} = 6500V)

IXYS Semiconductor GmbH
Edisonstraße 15
D-68623 Lampertheim
Tel: +49 6206 503-0
Fax: +49 6206 503-627
E-mail: marcom@ixys.de



IXYS UK Westcode Ltd
Langley Park Way, Langley Park,
Chippenham, Wiltshire, SN15 1GE.
Tel: +44 (0)1249 444524
Fax: +44 (0)1249 659448
E-mail: sales@ixysuk.com

IXYS Corporation
1590 Buckeye Drive
Milpitas CA 95035-7418
Tel: +1 (408) 457 9000
Fax: +1 (408) 496 0670
E-mail: sales@ixys.net

www.ixysuk.com

www.ixys.net

IXYS Long Beach
IXYS Long Beach, Inc
2500 Mira Mar Ave, Long Beach
CA 90815
Tel: +1 (562) 296 6584
Fax: +1 (562) 296 6585
E-mail: service@ixyslongbeach.com

The information contained herein is confidential and is protected by Copyright. The information may not be used or disclosed except with the written permission of and in the manner permitted by the proprietors IXYS UK Westcode Ltd.

© IXYS UK Westcode Ltd.

In the interest of product improvement, IXYS UK Westcode Ltd reserves the right to change specifications at any time without prior notice.

Devices with a suffix code (2-letter, 3-letter or letter/digit/letter combination) added to their generic code are not necessarily subject to the conditions and limits contained in this report.



Disclaimer Notice - Information furnished is believed to be accurate and reliable. However, users should independently evaluate the suitability of and test each product selected for their own applications. Littelfuse products are not designed for, and may not be used in, all applications. Read complete Disclaimer Notice at www.littelfuse.com/disclaimer-electronics.