

IGBT with optional Diode

$V_{CES} = 600\text{ V}$
 $I_{C25} = 60\text{ A}$
 $V_{CE(sat) typ} = 2.1\text{ V}$

High Speed,
Low Saturation Voltage

Replacements:

IXXH30N60B3D1 / IXYP30N65B3D1

IXXH30N65B4D1 / IXXH30N65B4D1

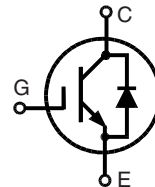

TO-247 AD

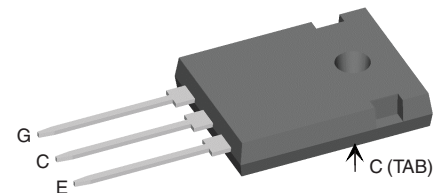

Gate, Emitter, Collector, TAB = Collector

Symbol	Conditions	Maximum Ratings	
V_{CES}	$T_J = 25^\circ\text{C to } 150^\circ\text{C}$	600	V
V_{CGR}	$T_J = 25^\circ\text{C to } 150^\circ\text{C}; R_{GE} = 20\text{ k}\Omega$	600	V
V_{GES}	Continuous	± 20	V
V_{GEM}	Transient	± 30	V
I_{C25}	$T_C = 25^\circ\text{C}$	60	A
I_{C90}	$T_C = 90^\circ\text{C}$	35	A
I_{CM}	$T_C = 90^\circ\text{C}, t_p = 1\text{ ms}$	70	A
RBSOA	$V_{GE} = \pm 15\text{ V}, T_J = 125^\circ\text{C}, R_G = 10\ \Omega$ Clamped inductive load, $L = 30\ \mu\text{H}$	$I_{CM} = 110$ $V_{CEK} < V_{CES}$	A
t_{SC} (SCSOA)	$V_{GE} = \pm 15\text{ V}, V_{CE} = 600\text{ V}, T_J = 125^\circ\text{C}$ $R_G = 10\ \Omega$, non repetitive	10	μs
P_C	$T_C = 25^\circ\text{C}$	IGBT	250 W
		Diode	80 W
T_J		-55 ... +150	$^\circ\text{C}$
T_{stg}		-40 ... +150	$^\circ\text{C}$
	Maximum lead temperature for soldering 1.6 mm (0.062 in.) from case for 10 s	300	$^\circ\text{C}$
M_d	Mounting torque	TO-220	0.4 - 0.6 Nm
		TO-247	0.8 - 1.2 Nm
Weight		6	g

Features

- NPT IGBT technology
- low switching losses
- low tail current
- no latch up
- short circuit capability
- positive temperature coefficient for easy paralleling
- MOS input, voltage controlled
- optional ultra fast diode
- International standard package

Advantages

- Space savings
- High power density

Typical Applications

- AC motor speed control
- DC servo and robot drives
- DC choppers
- Uninterruptible power supplies (UPS)
- Switch-mode and resonant-mode power supplies

Symbol	Conditions	Characteristic Values ($T_J = 25^\circ\text{C}$, unless otherwise specified)		
		min.	typ.	max.
$V_{(BR)CES}$	$V_{GE} = 0\text{ V}$	600		V
$V_{GE(th)}$	$I_C = 0.7\text{ mA}, V_{CE} = V_{GE}$	3		V
I_{CES}	$V_{CE} = V_{CES}$	$T_J = 25^\circ\text{C}$		0.1 mA
		$T_J = 125^\circ\text{C}$	1	mA
I_{GES}	$V_{CE} = 0\text{ V}, V_{GE} = \pm 20\text{ V}$			$\pm 500\text{ nA}$
$V_{CE(sat)}$	$I_C = 35\text{ A}, V_{GE} = 15\text{ V}$	2.2	2.7	V

IXYS reserves the right to change limits, test conditions and dimensions.

20190131a

Symbol	Conditions	Characteristic Values		
		(T _J = 25°C, unless otherwise specified)		
		min.	typ.	max.
C _{ies}	V _{CE} = 25 V, V _{GE} = 0 V, f = 1 MHz		1600	pF
C _{oes}			150	pF
C _{res}			90	pF
Q _g	I _C = 35 A, V _{GE} = 15 V, V _{CE} = 480 V		120	nC
t _{d(on)}	Inductive load, T _J = 125°C I _C = 35 A, V _{GE} = ±15 V, V _{CE} = 300 V, R _G = 10 Ω		30	ns
t _r			45	ns
t _{d(off)}			320	ns
t _f			70	ns
E _{on}			1.6	mJ
E _{off}			0.8	mJ
R _{thJC}				0.5 K/W
R _{thCH}	TO 247 Package with heatsink compound	0.25		K/W
R _{thCH}	TO 220 Package with heatsink compound	0.5		K/W

Reverse Diode (FRED) [D1 version only]

(T_J = 25°C, unless otherwise specified)

Symbol	Conditions	Characteristic Values		
		min.	typ.	max.
V _F	I _F = 35 A, V _{GE} = 0 V	2.1	2.4	V
	I _F = 35 A, V _{GE} = 0 V, T _J = 125°C	1.6		V
I _F	T _C = 25°C			45 A
	T _C = 90°C			25 A
I _{RM}	I _F = 15 A, -di _F /dt = 400 A/μs, V _R = 300 V	13		A
t _{rr}	V _{GE} = 0 V, T _J = 125°C	90		ns
t _{rr}	I _F = 1 A, -di _F /dt = 100 A/μs, V _R = 30 V, V _{GE} = 0 V	40		ns
R _{thJC}				1.6 K/W

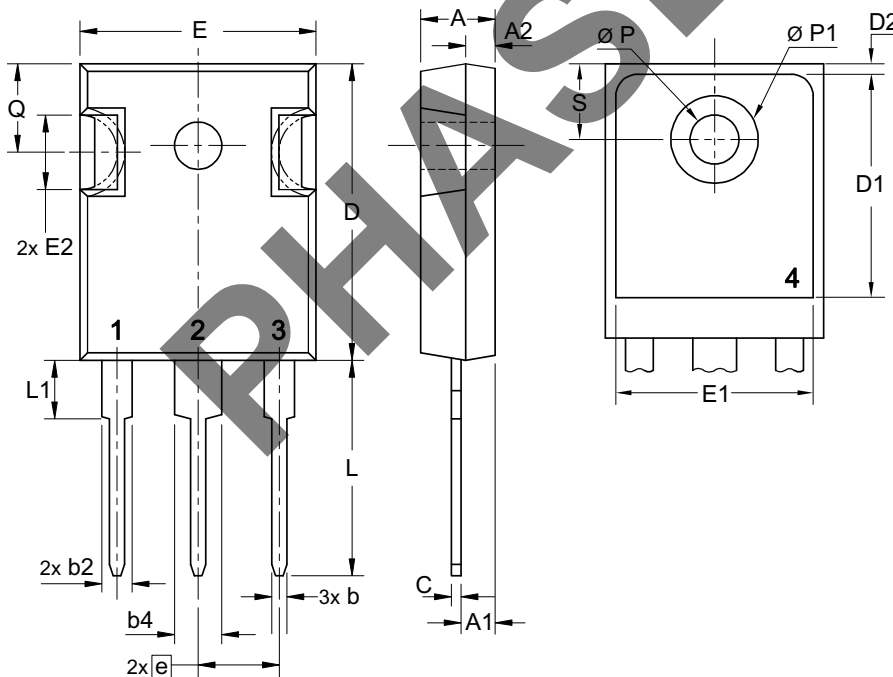
TO-247 AD Outline

Sym.	Inches		Millimeter	
	min.	max.	min.	max.
A	0.185	0.209	4.70	5.30
A1	0.087	0.102	2.21	2.59
A2	0.059	0.098	1.50	2.49
D	0.819	0.845	20.79	21.45
E	0.610	0.640	15.48	16.24
E2	0.170	0.216	4.31	5.48
e	0.215 BSC		5.46 BSC	
L	0.780	0.800	19.80	20.30
L1	-	0.177	-	4.49
Ø P	0.140	0.144	3.55	3.65
Q	0.212	0.244	5.38	6.19
S	0.242 BSC		6.14 BSC	
b	0.039	0.055	0.99	1.40
b2	0.065	0.094	1.65	2.39
b4	0.102	0.135	2.59	3.43
c	0.015	0.035	0.38	0.89
D1	0.515	-	13.07	-
D2	0.020	0.053	0.51	1.35
E1	0.530	-	13.45	-
Ø P1	-	0.29	-	7.39

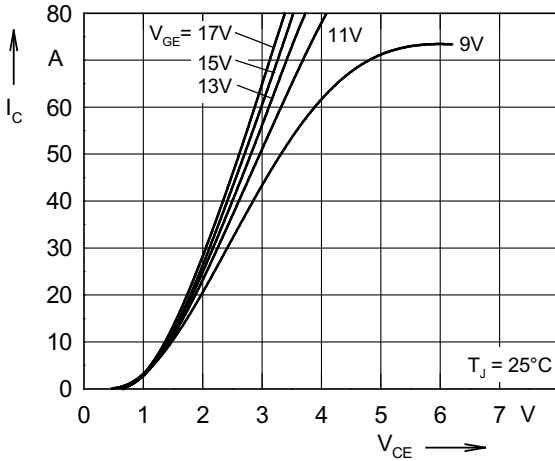

Fig. 1 Typ. output characteristics

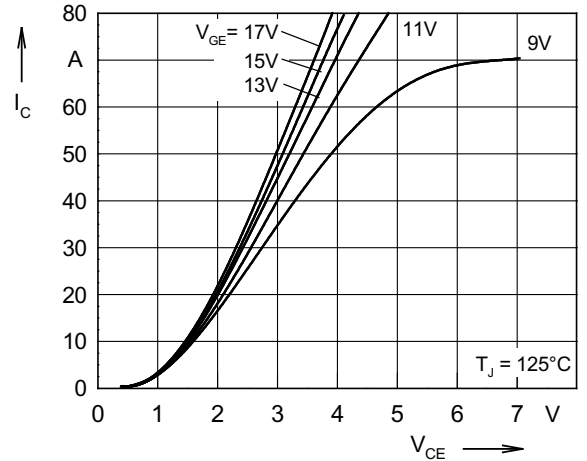

Fig. 2 Typ. output characteristics

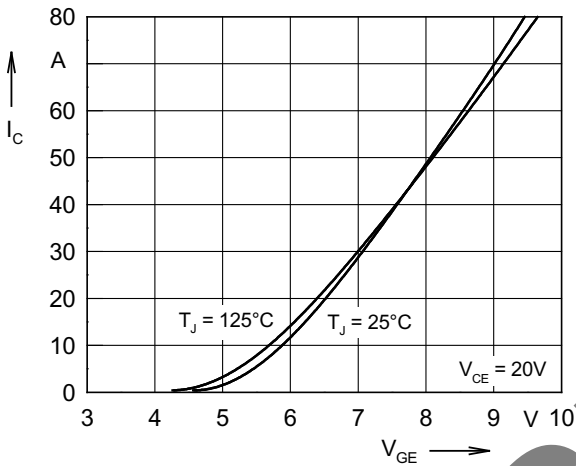

Fig. 3 Typ. transfer characteristics

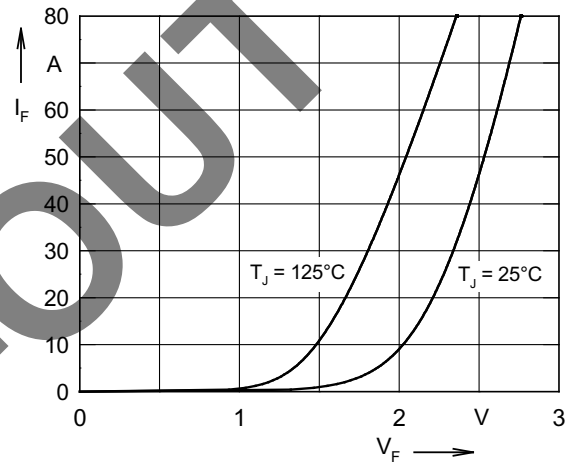

Fig. 4 Typ. forward characteristics of free wheeling diode

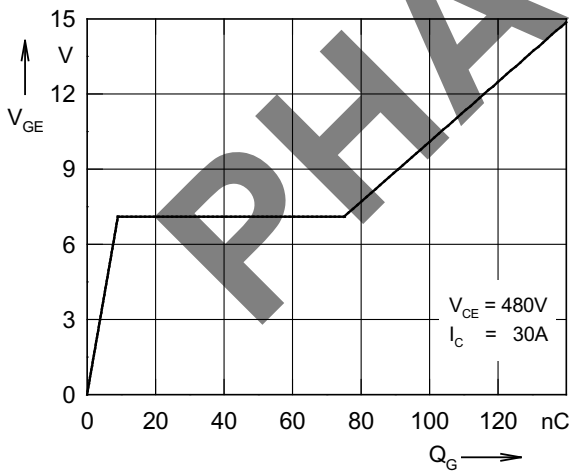

Fig. 5 Typ. turn on gate charge

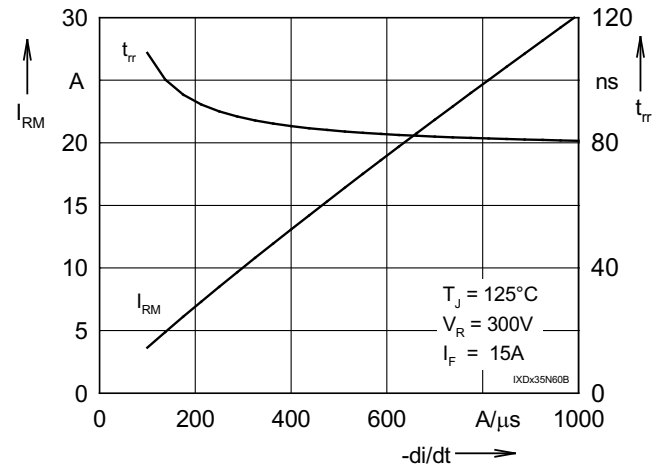

Fig. 6 Typ. turn off characteristics of free wheeling diode

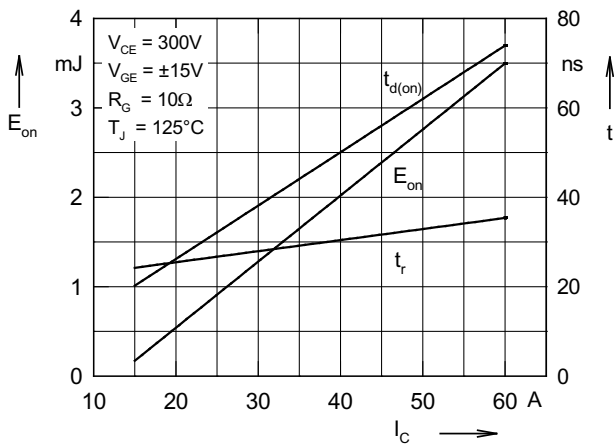

Fig. 7 Typ. turn on energy and switching times versus collector current

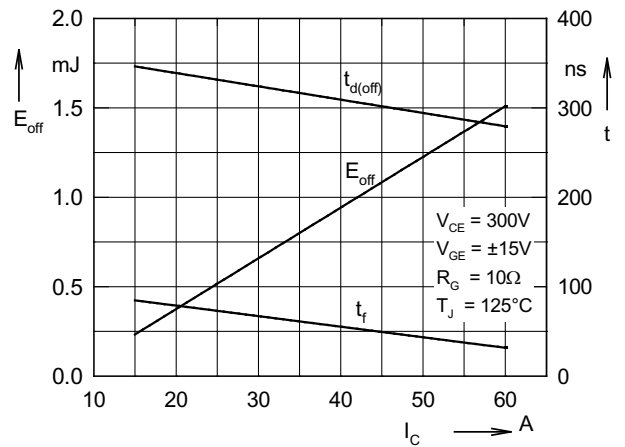

Fig. 8 Typ. turn off energy and switching times versus collector current

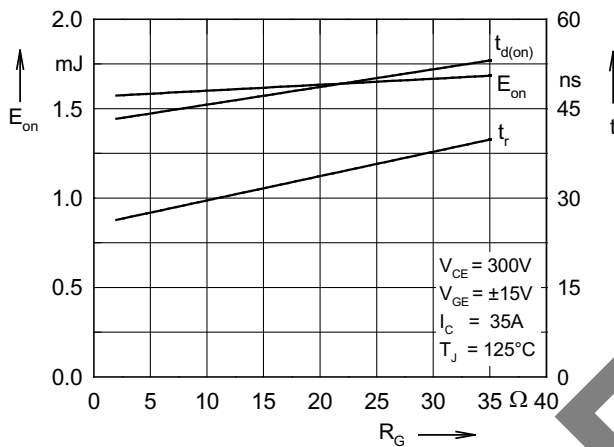

Fig. 9 Typ. turn on energy and switching times versus gate resistor

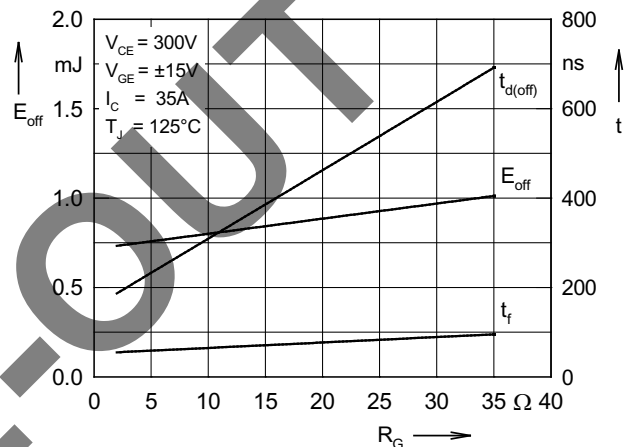

Fig. 10 Typ. turn off energy and switching times versus gate resistor

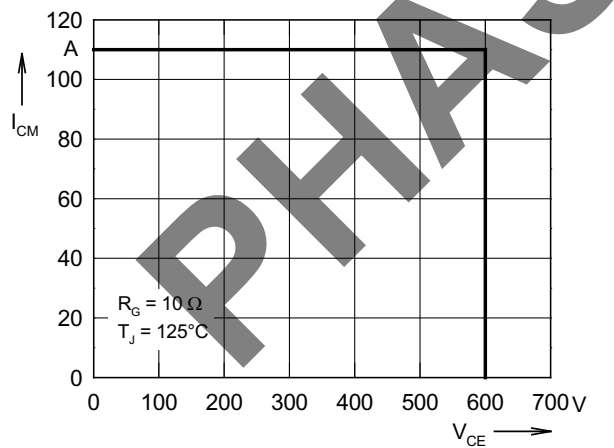

Fig. 11 Reverse biased safe operating area RBSOA

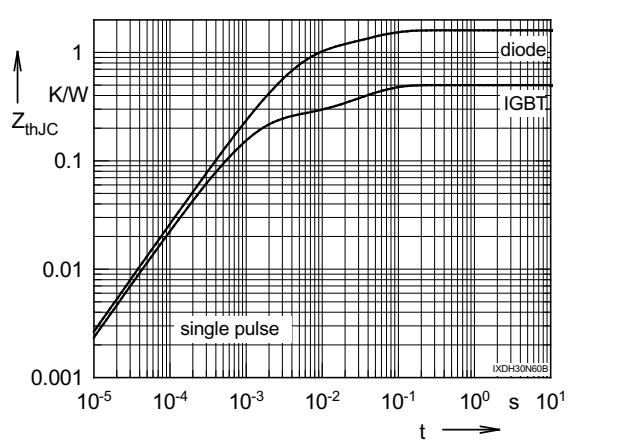

Fig. 12 Typ. transient thermal impedance