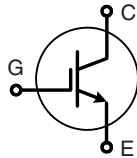
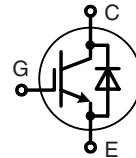
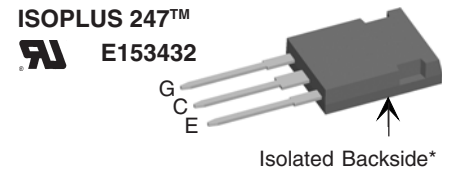

High Voltage IGBT with optional Diode ISOPLUS™ package

(Electrically Isolated Back Side)

 $V_{CES} = 1200\text{ V}$
 $I_{C25} = 50\text{ A}$
 $V_{CE(sat) \text{ typ}} = 2.4\text{ V}$

Short Circuit SOA Capability
Square RBSOA

IXDR 30N120

IXDR 30N120 D1
ISOPLUS 247™
E153432

Isolated Backside*

G = Gate C = Collector E = Emitter

| Symbol | Conditions | Maximum Ratings | |
|----------------------------|---|--------------------------------------|------------------|
| V_{CES} | $T_J = 25^\circ\text{C}$ to 150°C | 1200 | V |
| V_{CGR} | $T_J = 25^\circ\text{C}$ to 150°C ; $R_{GE} = 20\text{ k}\Omega$ | 1200 | V |
| V_{GES} | Continuous | ± 20 | V |
| V_{GEM} | Transient | ± 30 | V |
| I_{C25} | $T_C = 25^\circ\text{C}$ | 50 | A |
| I_{C90} | $T_C = 90^\circ\text{C}$ | 30 | A |
| I_{CM} | $T_C = 90^\circ\text{C}$, $t_p = 1\text{ ms}$ | 60 | A |
| RBSOA | $V_{GE} = \pm 15\text{ V}$, $T_J = 125^\circ\text{C}$, $R_G = 47\ \Omega$ Clamped inductive load, $L = 30\text{ mH}$ | $I_{CM} = 50$ $V_{CEK} < V_{CES}$ | A |
| t_{SC} (SCSOA) | $V_{GE} = \pm 15\text{ V}$, $V_{CE} = V_{CES}$, $T_J = 125^\circ\text{C}$ $R_G = 47\ \Omega$, non repetitive | 10 | μs |
| P_C | $T_C = 25^\circ\text{C}$ | IGBT | 200 W |
| | | Diode | 95 W |
| T_J | | -55 ... +150 | $^\circ\text{C}$ |
| T_{stg} | | -55 ... +150 | $^\circ\text{C}$ |
| V_{ISOL} | 50/60 Hz, RMS $I_{ISOL} \leq 1\text{ mA}$ | 2500 | V~ |
| Weight | | 6 | g |

Features

- NPT IGBT technology
- high switching speed
- low switching losses
- square RBSOA, no latch up
- high short circuit capability
- positive temperature coefficient for easy paralleling
- MOS input, voltage controlled
- fast recovery epitaxial diode
- Epoxy meets UL 94V-0
- Isolated and UL registered E153432

Advantages

- DCB Isolated mounting tab
- Meets TO-247AD package Outline
- Package for clip or spring mounting
- Space savings
- High power density

Typical Applications

- AC motor speed control
- DC servo and robot drives
- DC choppers
- Uninterruptible power supplies (UPS)
- Switch-mode and resonant-mode power supplies

| Symbol | Conditions | Characteristic Values ($T_J = 25^\circ\text{C}$, unless otherwise specified) | | |
|---------------|--|---|------|---------------------|
| | | min. | typ. | max. |
| $V_{(BR)CES}$ | $V_{GE} = 0\text{ V}$ | 1200 | | V |
| $V_{GE(th)}$ | $I_C = 1\text{ mA}$, $V_{CE} = V_{GE}$ | 4.5 | | 6.5 V |
| I_{CES} | $V_{CE} = V_{CES}$, $T_J = 25^\circ\text{C}$ $T_J = 125^\circ\text{C}$ | | | 1.5 mA |
| | | | 2.5 | mA |
| I_{GES} | $V_{CE} = 0\text{ V}$, $V_{GE} = \pm 20\text{ V}$ | | | $\pm 500\text{ nA}$ |
| $V_{CE(sat)}$ | $I_C = 30\text{ A}$, $V_{GE} = 15\text{ V}$ | 2.4 | 2.9 | V |

| Symbol | Conditions | Characteristic Values | | |
|---------------------|---|---|------|---------|
| | | (T _J = 25°C, unless otherwise specified) | | |
| | | min. | typ. | max. |
| C _{ies} | V _{CE} = 25 V, V _{GE} = 0 V, f = 1 MHz | | 1650 | pF |
| C _{oes} | | | 250 | pF |
| C _{res} | | | 110 | pF |
| Q _g | I _C = 30 A, V _{GE} = 15 V, V _{CE} = 0.5 V _{CES} | | 120 | nC |
| t _{d(on)} | Inductive load, T _J = 125°C I _C = 30 A, V _{GE} = ±15 V, V _{CE} = 600 V, R _G = 47 Ω | | 100 | ns |
| t _r | | | 70 | ns |
| t _{d(off)} | | | 500 | ns |
| t _f | | | 70 | ns |
| E _{on} | | | 4.6 | mJ |
| E _{off} | | 3.4 | mJ | |
| R _{thJC} | | | | 0.6 K/W |
| R _{thCH} | Package with heatsink compound | | 0.25 | K/W |

| Symbol | Conditions | Characteristic Values | | |
|-------------------|---|---|------|---------|
| | | (T _J = 25°C, unless otherwise specified) | | |
| | | min. | typ. | max. |
| V _F | I _F = 30 A, V _{GE} = 0 V | | 2.5 | 2.75 V |
| | I _F = 30 A, V _{GE} = 0 V, T _J = 125°C | | 2.0 | V |
| I _F | T _C = 25°C | | | 50 A |
| | T _C = 90°C | | | 27 A |
| I _{RM} | I _F = 30 A, -di _F /dt = 400 A/μs, V _R = 600 V | | 20 | A |
| t _{rr} | V _{GE} = 0 V, T _J = 125°C | | 200 | ns |
| t _{rr} | I _F = 1 A, -di _F /dt = 100 A/μs, V _R = 30 V, V _{GE} = 0 V | | 40 | ns |
| R _{thJC} | | | | 1.3 K/W |

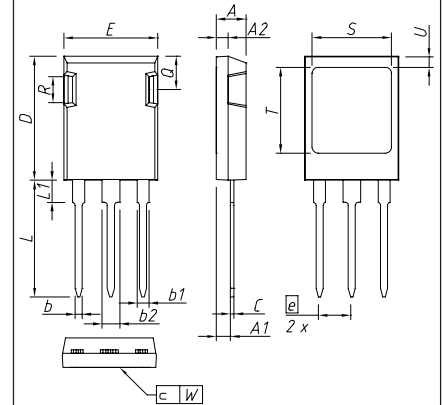
ISOPLUS247™ OUTLINE

| DIM. | MILLIMETER | | INCHES | |
|------|------------|-------|-----------|-------|
| | MIN | MAX | MIN | MAX |
| A | 4,83 | 5,21 | 0,190 | 0,205 |
| A1 | 2,29 | 2,54 | 0,090 | 0,100 |
| A2 | 1,91 | 2,16 | 0,075 | 0,085 |
| b | 1,14 | 1,40 | 0,045 | 0,055 |
| b1 | 1,91 | 2,15 | 0,075 | 0,085 |
| b2 | 2,92 | 3,20 | 0,115 | 0,126 |
| c | 0,61 | 0,83 | 0,024 | 0,033 |
| D | 20,80 | 21,34 | 0,819 | 0,840 |
| E | 15,75 | 16,13 | 0,620 | 0,635 |
| e | 5,45 BSC | | 0,215 BSC | |
| L | 19,81 | 20,60 | 0,780 | 0,811 |
| L1 | 3,81 | 4,38 | 0,150 | 0,172 |
| Q | 5,59 | 6,20 | 0,220 | 0,244 |
| R | 4,32 | 4,85 | 0,170 | 0,191 |
| S | 13,21 | 13,72 | 0,520 | 0,540 |
| T | 15,75 | 16,26 | 0,620 | 0,640 |
| U | 1,65 | 2,03 | 0,065 | 0,080 |
| W | - | 0,10 | - | 0,004 |

The convex bow of substrate is typ. < 0.04 mm over plastic surface level of device bottom side
 This drawing will meet all dimensions requirement of JEDEC outline TO-247 AD except screw hole and except Lmax.

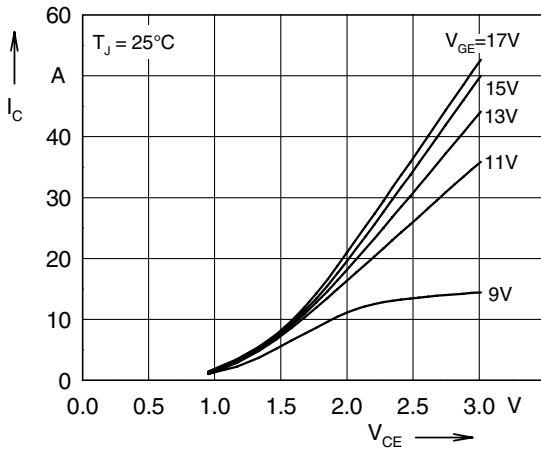

Fig. 1 Typ. output characteristics

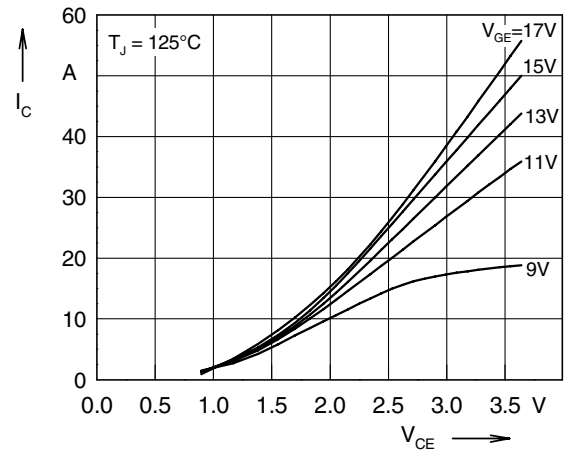

Fig. 2 Typ. output characteristics

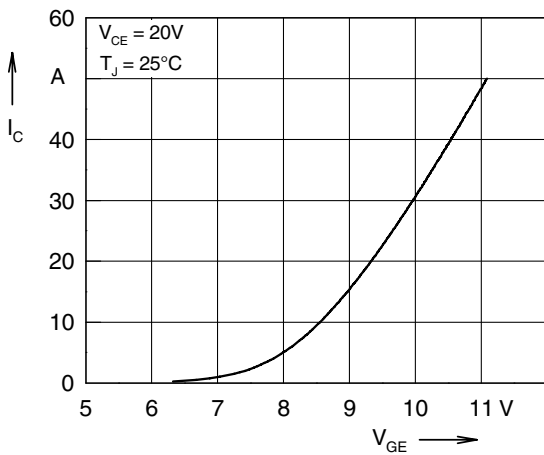

Fig. 3 Typ. transfer characteristics

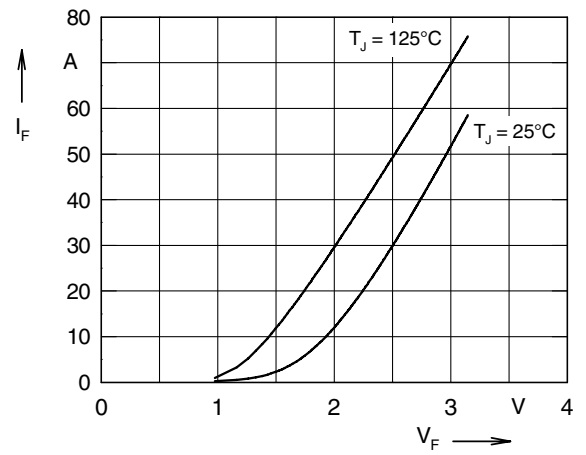

Fig. 4 Typ. forward characteristics of free wheeling diode

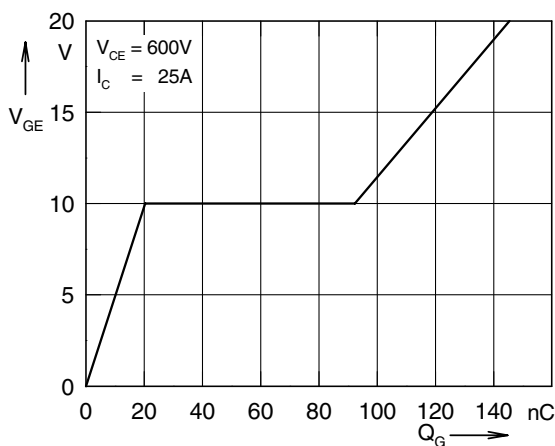

Fig. 5 Typ. turn on gate charge

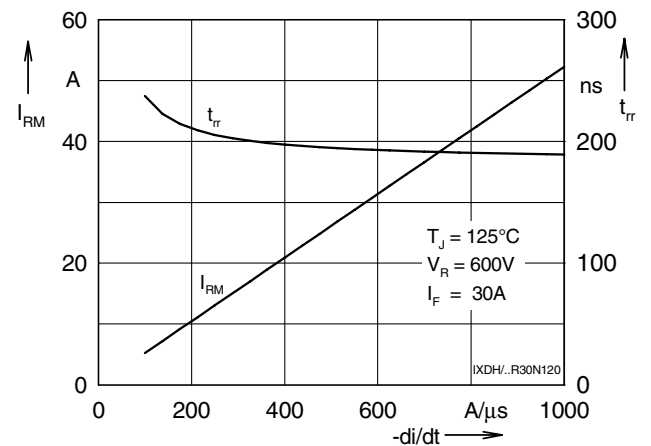

Fig. 6 Typ. turn off characteristics of free wheeling diode

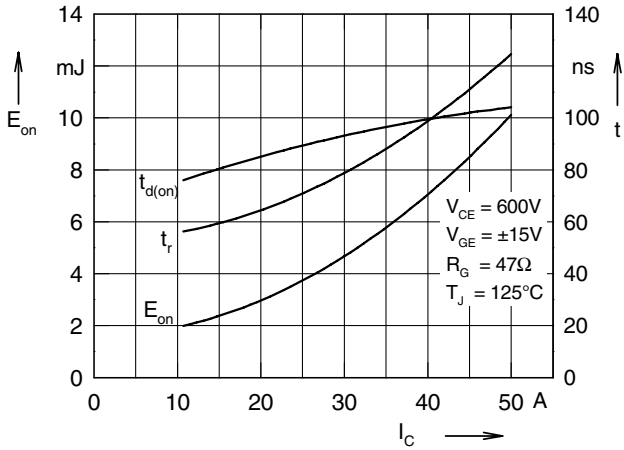

Fig. 7 Typ. turn on energy and switching times versus collector current

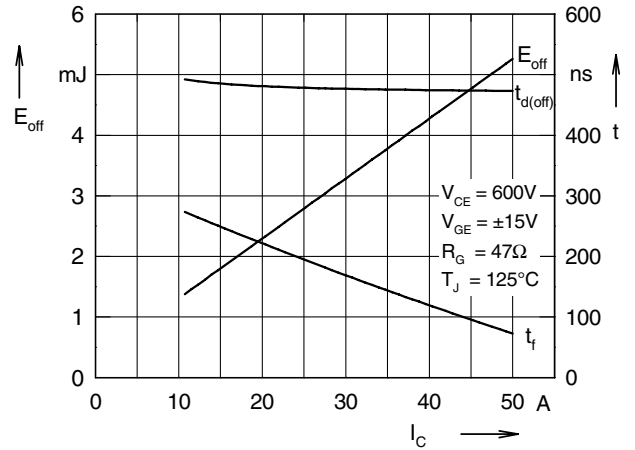

Fig. 8 Typ. turn off energy and switching times versus collector current

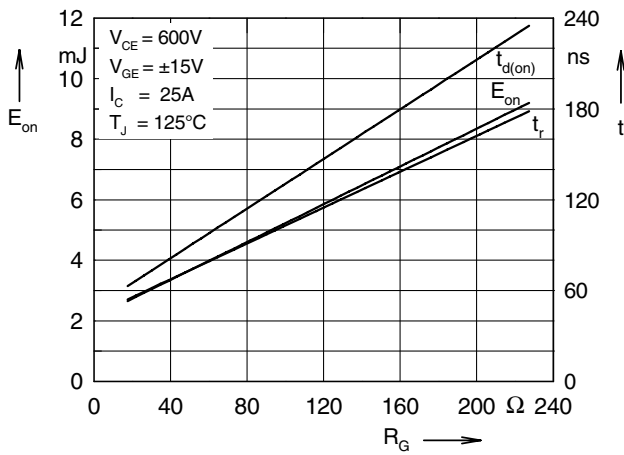

Fig. 9 Typ. turn on energy and switching times versus gate resistor

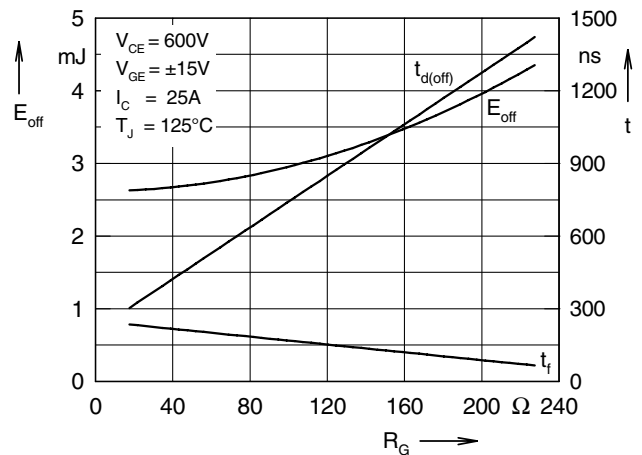

Fig. 10 Typ. turn off energy and switching times versus gate resistor

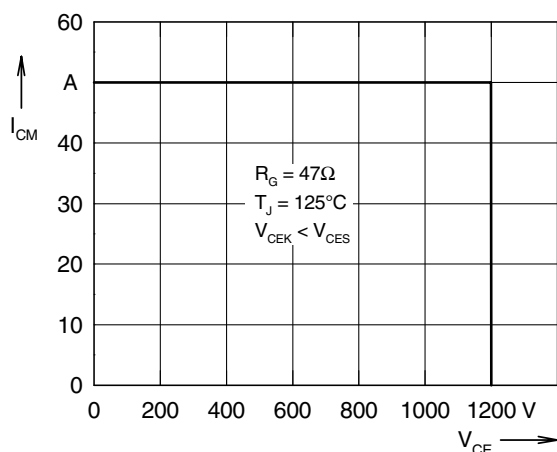

Fig. 11 Reverse biased safe operating area RBSOA

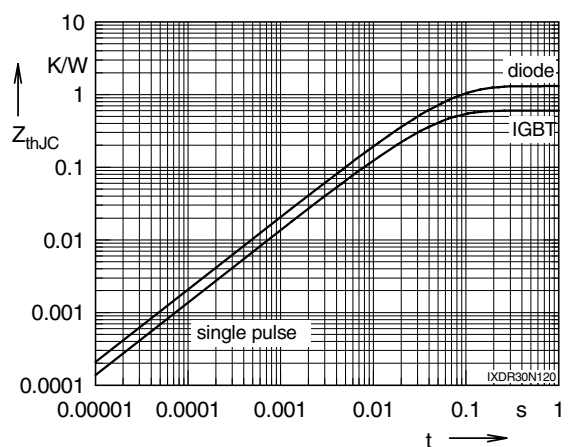

Fig. 12 Typ. transient thermal impedance



Disclaimer Notice - Information furnished is believed to be accurate and reliable. However, users should independently evaluate the suitability of and test each product selected for their own applications. Littelfuse products are not designed for, and may not be used in, all applications. Read complete Disclaimer Notice at www.littelfuse.com/disclaimer-electronics.