

# High Voltage IGBT w/ Sonic Diode

**IXGT16N170A**  
**IXGH16N170A**  
**IXGT16N170AH1**  
**IXGH16N170AH1**

$V_{CES} = 1700V$   
 $I_{C90} = 11A$   
 $V_{CE(sat)} \leq 5.0V$   
 $t_{fi(typ)} = 35ns$

Symbol	Test Conditions	Maximum Ratings	
$V_{CES}$	$T_J = 25^\circ C$ to $150^\circ C$	1700	V
$V_{CGR}$	$T_J = 25^\circ C$ to $150^\circ C$ , $R_{GE} = 1M\Omega$	1700	V
$V_{GES}$	Continuous	$\pm 20$	V
$V_{GEM}$	Transient	$\pm 30$	V
$I_{C25}$	$T_C = 25^\circ C$	16	A
$I_{C90}$	$T_C = 90^\circ C$	11	A
$I_{F90}$	$T_C = 90^\circ C$	17	A
$I_{CM}$	$T_C = 25^\circ C$ , 1ms	40	A
<b>SSOA</b>	$V_{GE} = 15V$ , $T_{VJ} = 125^\circ C$ , $R_G = 10\Omega$	$I_{CM} = 40$	A
<b>(RBSOA)</b>	Clamped Inductive Load	$0.8 \cdot V_{CES}$	
$t_{sc}$	$V_{GE} = 15V$ , $V_{CE} = 1200V$ , $T_J = 125^\circ C$	10	$\mu s$
<b>(SCSOA)</b>	$R_G = 22\Omega$ , Non Repetitive		
$P_C$	$T_C = 25^\circ C$	190	W
$T_J$		-55 ... +150	$^\circ C$
$T_{JM}$		150	$^\circ C$
$T_{stg}$		-55 ... +150	$^\circ C$
$T_L$	Maximum Lead Temperature for Soldering	300	$^\circ C$
$T_{SOLD}$	Plastic Body for 10s	260	$^\circ C$
$M_d$	Mounting Torque (TO-247)	1.13/10	Nm/lb.in
<b>Weight</b>	TO-268	4	g
	TO-247	6	g

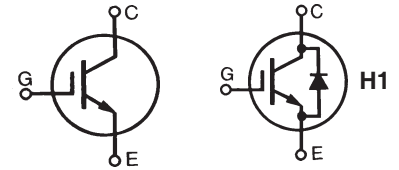

**TO-268 (IXGT)**

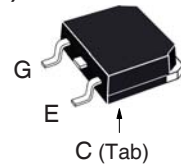

**TO-247 (IXGH)**

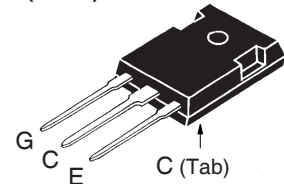

G = Gate      C = Collector  
 E = Emitter    Tab = Collector

### Features

- High Blocking Voltage
- International Standard Packages
- Low Conduction Losses
- Anti-Parallel Sonic Diode
- High Blocking Voltage
- High Current Handling Capability

### Advantages

- Low Gate Drive Requirement
- High Power Density

### Applications

- Switch-Mode and Resonant-Mode Power Supplies
- Uninterruptible Power Supplies (UPS)
- AC Choppers
- Capacitor Discharge Circuits
- AC Motor Drives
- DC Servo & Robot Drives

Symbol	Test Conditions	Characteristic Values		
		Min.	Typ.	Max.
$BV_{CES}$	$I_C = 250\mu A$ , $V_{GE} = 0V$	1700		V
$V_{GE(th)}$	$I_C = 250\mu A$ , $V_{CE} = V_{GE}$	3.0		5.0 V
$I_{CES}$	$V_{CE} = 0.8 \cdot V_{CES}$ , $V_{GE} = 0V$  $T_J = 125^\circ C$	16N170A		50 $\mu A$
		16N170AH1		100 $\mu A$
		16N170A		750 $\mu A$
		16N170AH1		1.5 mA
$I_{GES}$	$V_{CE} = 0V$ , $V_{GE} = \pm 20V$			$\pm 100$ nA
$V_{CE(sat)}$	$I_C = 11A$ , $V_{GE} = 15V$ , Note 1  $T_J = 125^\circ C$		4.0	5.0 V
			4.5	V

Symbol	Test Conditions	Characteristic Values		
		Min.	Typ.	Max.
$g_{fs}$	$I_C = 16A, V_{CE} = 10V, \text{Note 1}$	6.0	12.5	S
$C_{ies}$ $C_{oes}$ $C_{res}$	$V_{CE} = 25V, V_{GE} = 0V, f = 1MHz$	16N170A 16N170AH1	1500	pF
			99	pF
			110	pF
		33	pF	
$Q_{g(on)}$ $Q_{ge}$ $Q_{gc}$	$I_C = 11A, V_{GE} = 15V, V_{CE} = 0.5 \cdot V_{CES}$		70	nC
			9	nC
			32	nC
$t_{d(on)}$ $t_{ri}$ $E_{on}$ $t_{d(off)}$ $t_{fi}$ $E_{off}$	<b>Inductive load, <math>T_J = 25^\circ C</math></b> $I_C = 16A, V_{GE} = 15V$ $V_{CE} = 0.5 \cdot V_{CES}, R_G = 10\Omega$ Note 2		12	ns
			22	ns
			2.35	mJ
			200	300 ns
			35	150 ns
			0.38	1.50 mJ
$t_{d(on)}$ $t_{ri}$ $E_{on}$ $t_{d(off)}$ $t_{fi}$ $E_{off}$	<b>Inductive load, <math>T_J = 125^\circ C</math></b> $I_C = 16A, V_{GE} = 15V$ $V_{CE} = 0.5 \cdot V_{CES}, R_G = 10\Omega$ Note 2		13	ns
			22	ns
			2.80	mJ
			210	ns
			88	ns
			0.67	mJ
$R_{thJC}$ $R_{thCS}$			0.65 °C/W 0.21 °C/W	

**Reverse Sonic Diode (FRD)**

Symbol	Test Conditions	Characteristic Values		
		Min.	Typ.	Max.
$V_F$	$I_F = 20A, V_{GE} = 0V, \text{Note 1}$	$T_J = 125^\circ C$	2.8	3.4 V
$t_{rr}$ $I_{RM}$	$I_F = 10A, V_{GE} = 0V,$ $-di_F/dt = 250A/\mu s, V_R = 900V$	$T_J = 125^\circ C$	300	ns
			550	ns
		$T_J = 125^\circ C$	13	A
			15	A
$R_{thJC}$			1.5 °C/W	

**Notes:**

1. Pulse test,  $t \leq 300\mu s$ , duty cycle,  $d \leq 2\%$ .
2. Switching times & energy losses may increase for higher  $V_{CE}$  (clamp),  $T_J$  or  $R_G$ .

**TO-268 Outline**

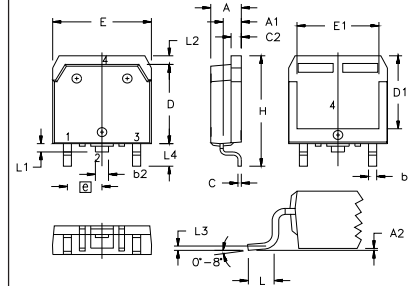

Terminals: 1 - Gate 2,4 - Collector  
3 - Emitter

SYM	INCHES		MILLIMETERS	
	MIN	MAX	MIN	MAX
A	.193	.201	4.90	5.10
A1	.106	.114	2.70	2.90
A2	.001	.010	0.02	0.25
b	.045	.057	1.15	1.45
b2	.075	.083	1.90	2.10
C	.016	.026	0.40	0.65
C2	.057	.063	1.45	1.60
D	.543	.551	13.80	14.00
D1	.488	.500	12.40	12.70
E	.624	.632	15.85	16.05
E1	.524	.535	13.30	13.60
e	.215 BSC		5.45 BSC	
H	.736	.752	18.70	19.10
L	.094	.106	2.40	2.70
L1	.047	.055	1.20	1.40
L2	.039	.045	1.00	1.15
L3	.010 BSC		0.25 BSC	
L4	.150	.161	3.80	4.10

**TO-247 Outline**

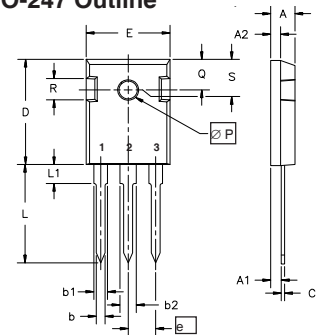

Terminals: 1 - Gate 2 - Collector  
3 - Emitter

Dim.	Millimeter		Inches	
	Min.	Max.	Min.	Max.
A	4.7	5.3	.185	.209
A <sub>1</sub>	2.2	2.54	.087	.102
A <sub>2</sub>	2.2	2.6	.059	.098
b	1.0	1.4	.040	.055
b <sub>1</sub>	1.65	2.13	.065	.084
b <sub>2</sub>	2.87	3.12	.113	.123
C	.4	.8	.016	.031
D	20.80	21.46	.819	.845
E	15.75	16.26	.610	.640
e	5.20	5.72	0.205	0.225
L	19.81	20.32	.780	.800
L1		4.50		.177
∅P	3.55	3.65	.140	.144
Q	5.89	6.40	0.232	0.252
R	4.32	5.49	.170	.216
S	6.15	BSC	242	BSC

IXYS Reserves the Right to Change Limits, Test Conditions, and Dimensions.

IXYS MOSFETs and IGBTs are covered by one or more of the following U.S. patents:	4,835,592	4,931,844	5,049,961	5,237,481	6,162,665	6,404,065 B1	6,683,344	6,727,585	7,005,734 B2	7,157,338B2
	4,860,072	5,017,508	5,063,307	5,381,025	6,259,123 B1	6,534,343	6,710,405 B2	6,759,692	7,063,975 B2	
	4,881,106	5,034,796	5,187,117	5,486,715	6,306,728 B1	6,583,505	6,710,463	6,771,478 B2	7,071,537	

Fig. 1. Output Characteristics @  $T_J = 25^\circ\text{C}$

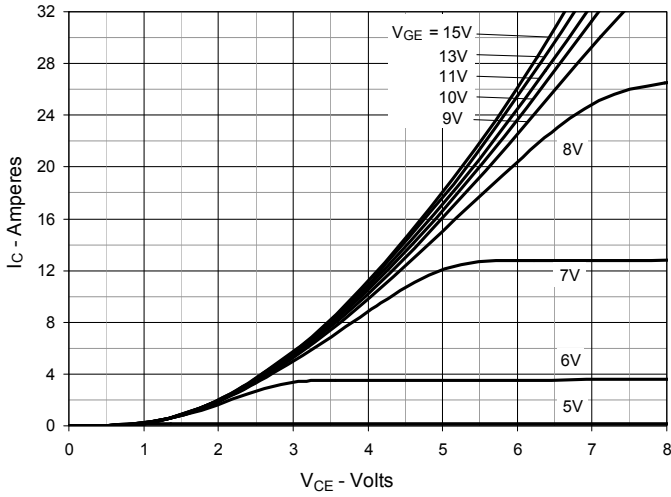

Fig. 2. Extended Output Characteristics @  $T_J = 25^\circ\text{C}$

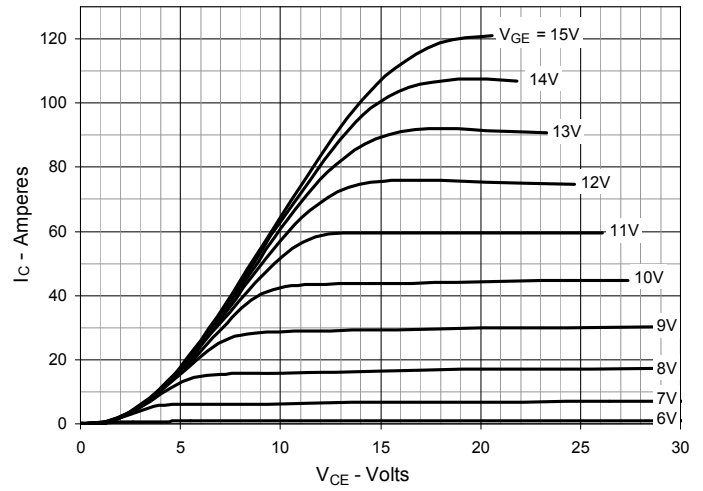

Fig. 3. Output Characteristics @  $T_J = 125^\circ\text{C}$

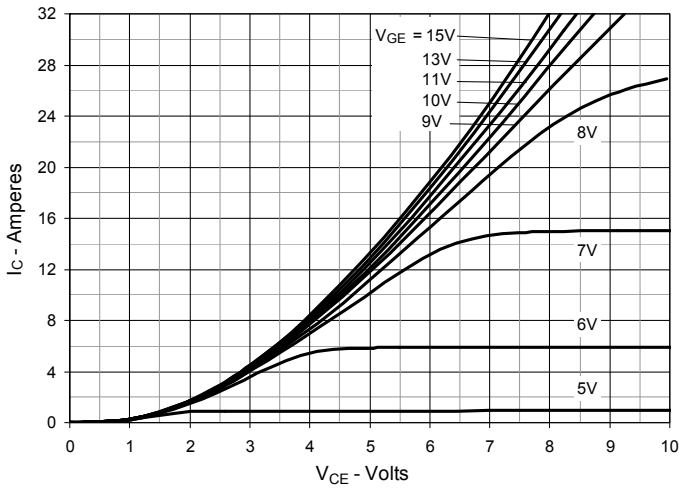

Fig. 4. Dependence of  $V_{CE(sat)}$  on Junction Temperature

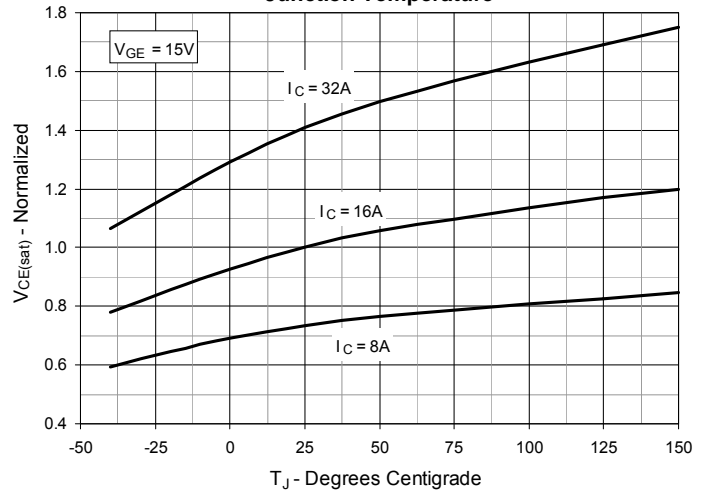

Fig. 5. Collector-to-Emitter Voltage vs. Gate-to-Emitter Voltage

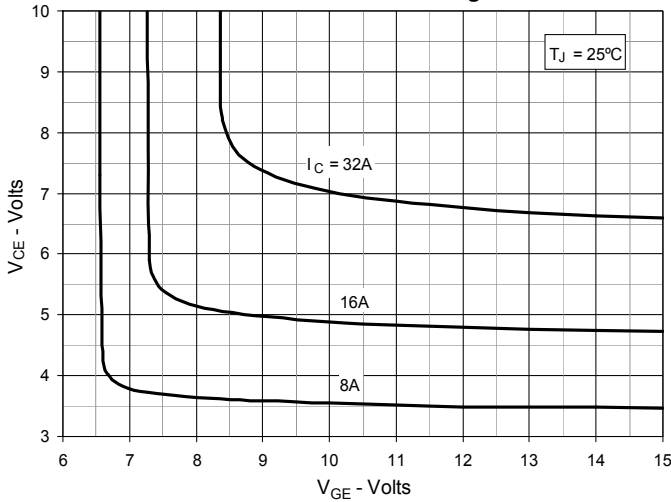

Fig. 6. Input Admittance

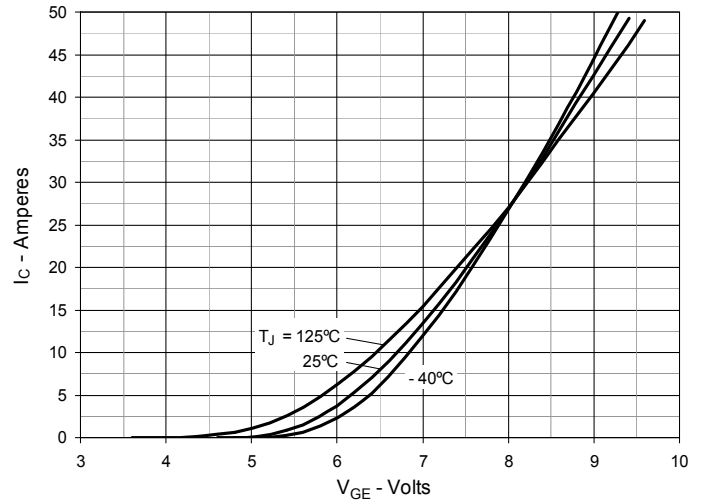

Fig. 7. Transconductance

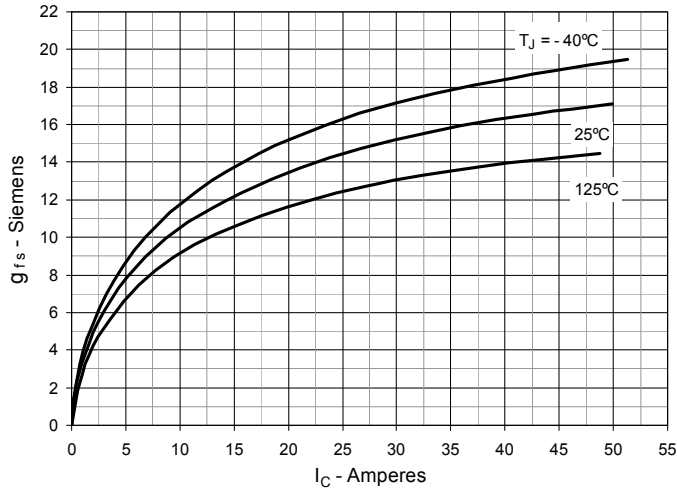

Fig. 8. Gate Charge

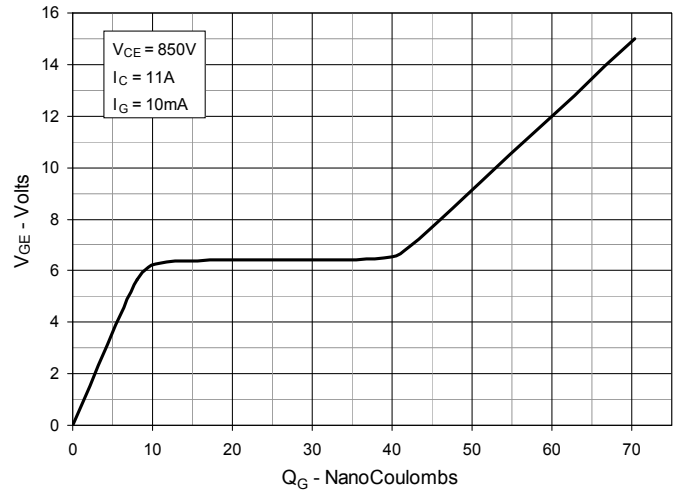

Fig. 9. Capacitance

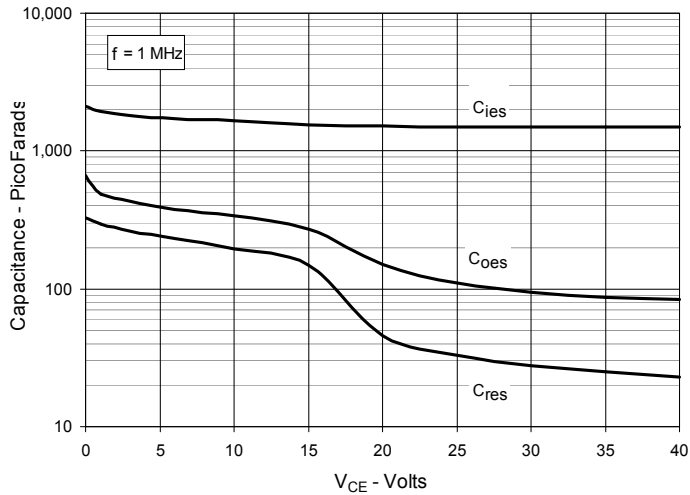

Fig. 10. Reverse-Bias Safe Operating Area

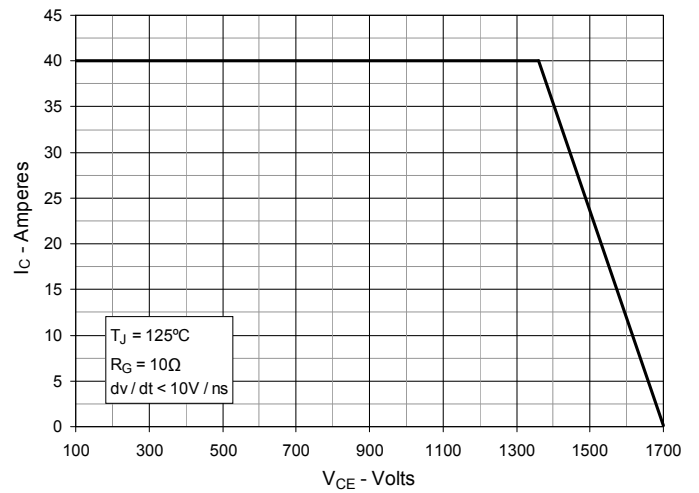
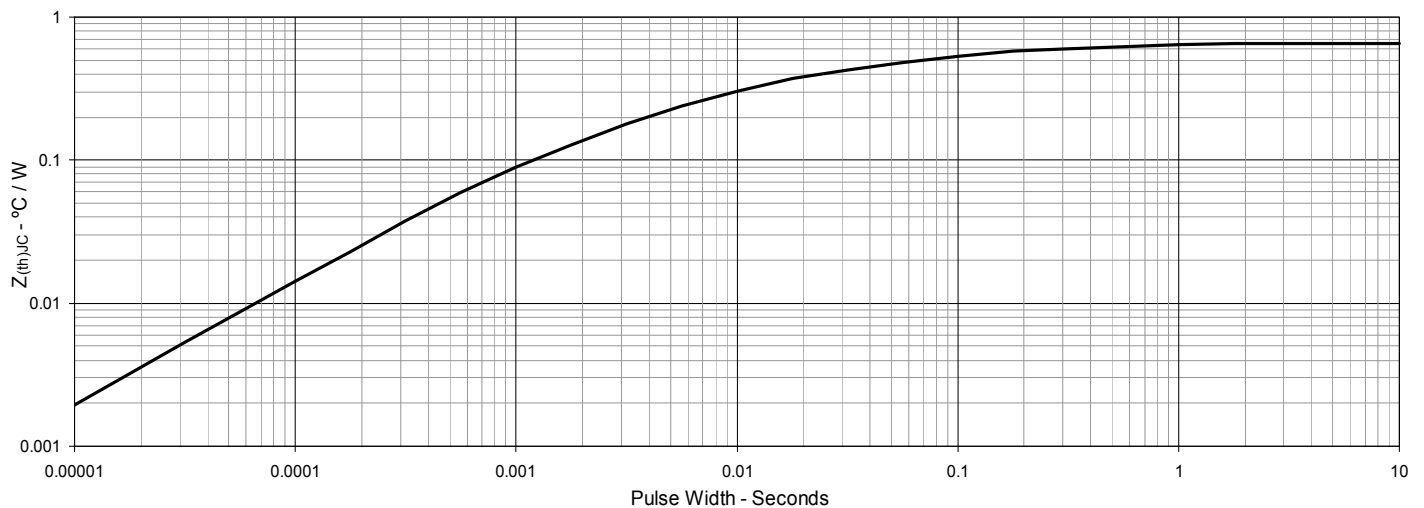

Fig. 11. Maximum Transient Thermal Impedance (IGBT)



**Fig. 12. Inductive Switching Energy Loss vs. Gate Resistance**



**Fig. 13. Inductive Switching Energy Loss vs. Collector Current**

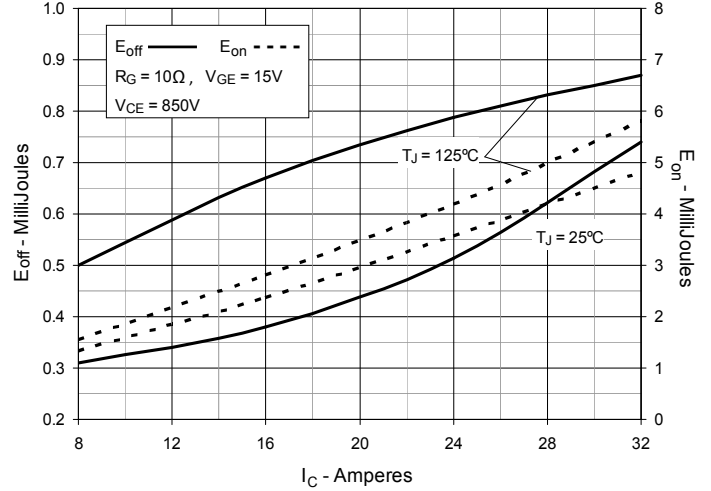

**Fig. 14. Inductive Switching Energy Loss vs. Junction Temperature**

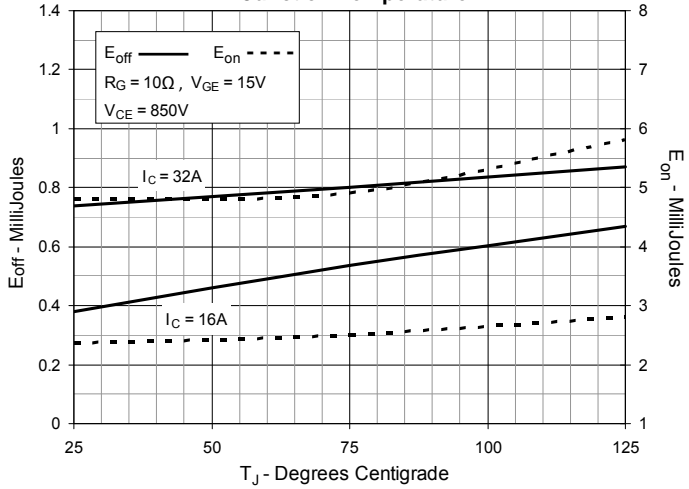

**Fig. 15. Inductive Turn-off Switching Times vs. Gate Resistance**

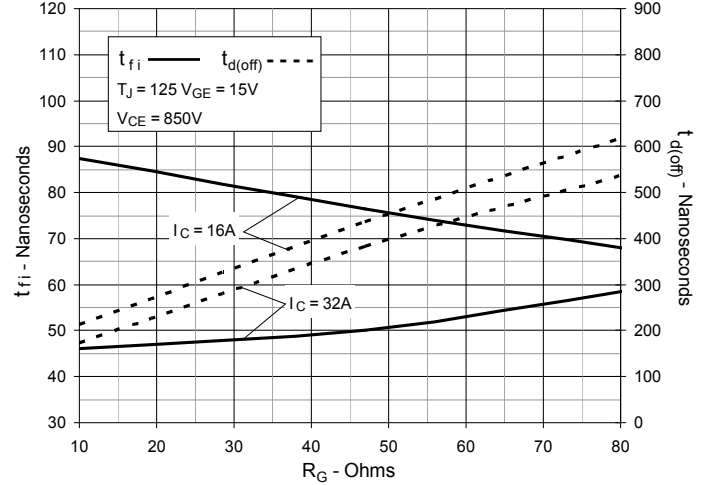

**Fig. 16. Inductive Turn-off Switching Times vs. Collector Current**

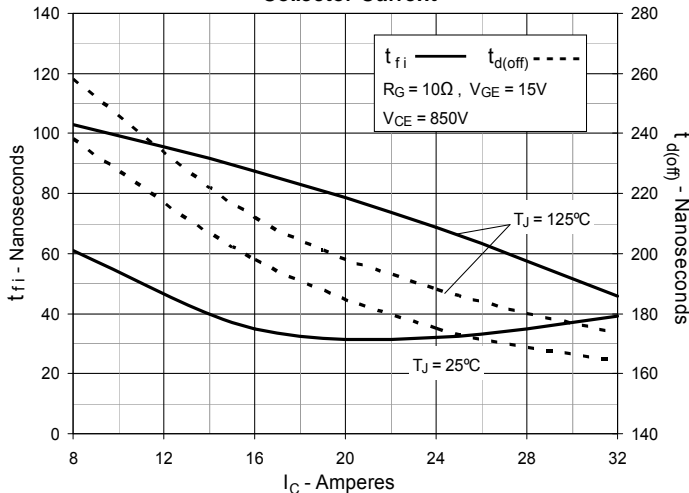

**Fig. 17. Inductive Turn-off Switching Times vs. Junction Temperature**

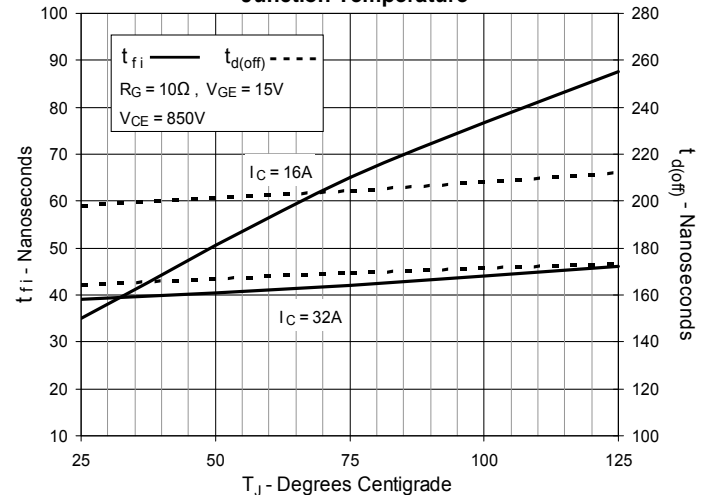

**Fig. 18. Inductive Turn-on Switching Times vs. Gate Resistance**

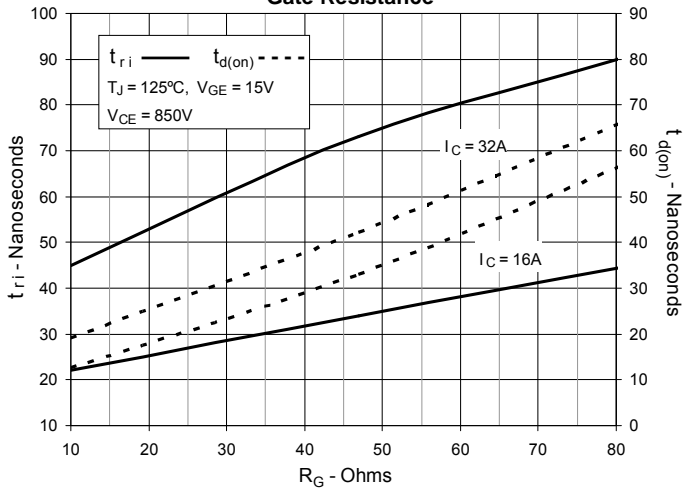

**Fig. 19. Inductive Turn-on Switching Times vs. Collector Current**

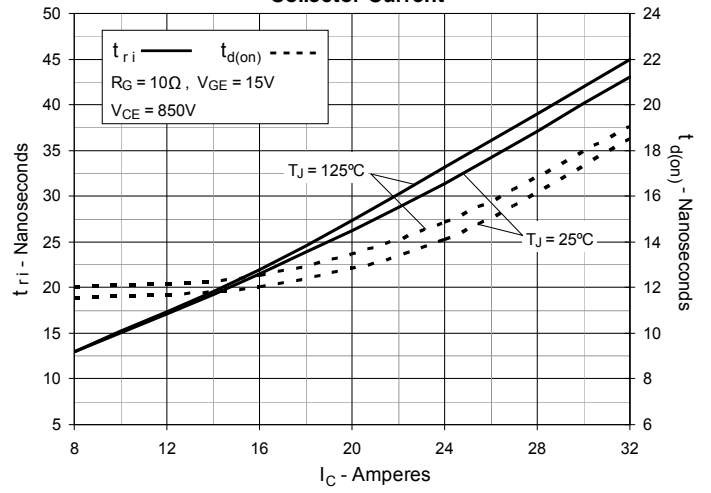

**Fig. 20. Inductive Turn-on Switching Times vs. Junction Temperature**

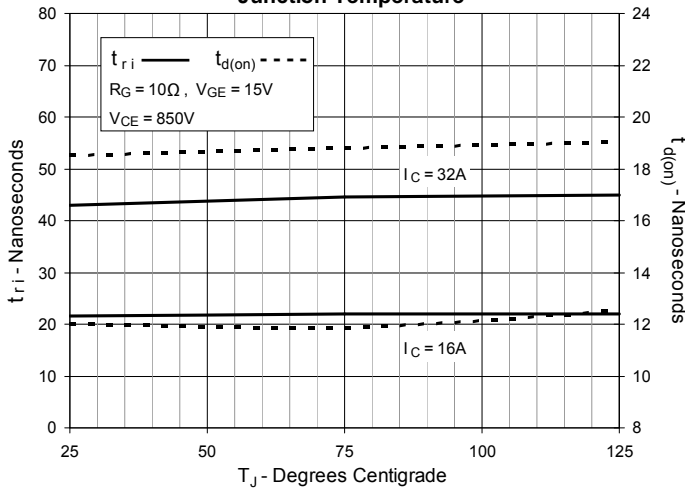

**Fig. 21. Forward Current  $I_F$  vs  $V_F$**



**Fig. 22. Reverse Recovery Charge  $Q_{rr}$  vs.  $-di_F/dt$**

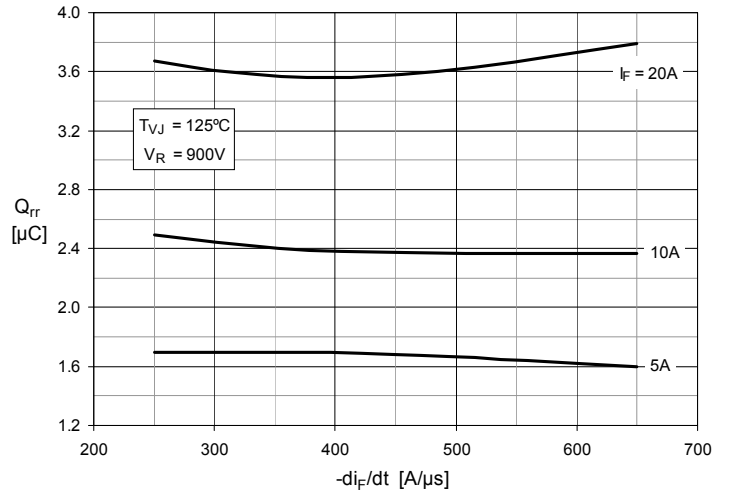

**Fig. 23. Peak Reverse Current  $I_{RM}$  vs.  $-di_F/dt$**

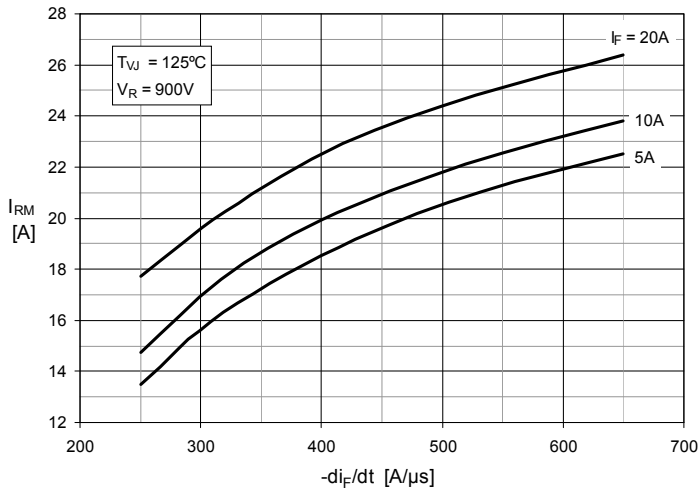

**Fig. 24. Recovery Time  $t_{rr}$  vs.  $-di_F/dt$**

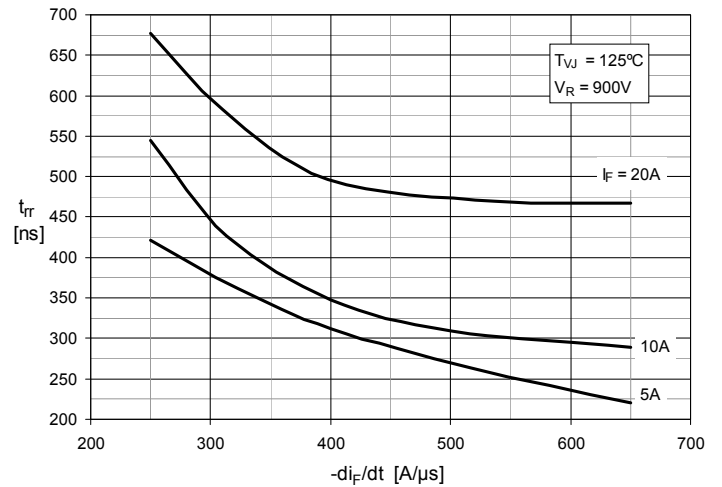

**Fig. 25. Recovery Energy  $E_{rec}$  vs  $-di_F/dt$**

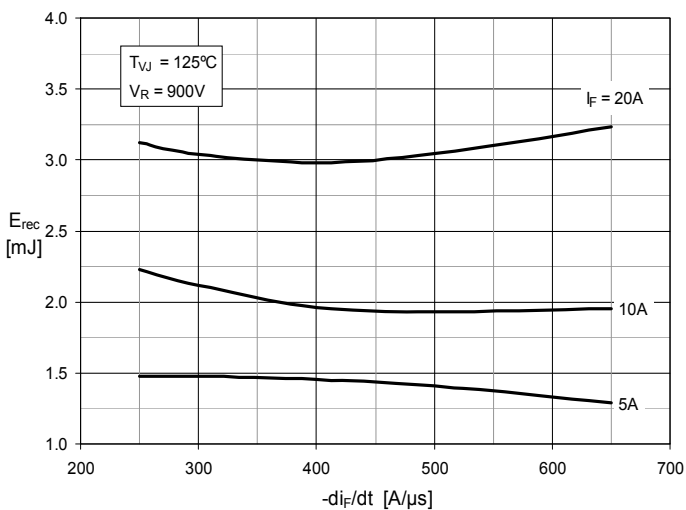

**Fig. 26. Maximum Transient Thermal Impedance (Diode)**

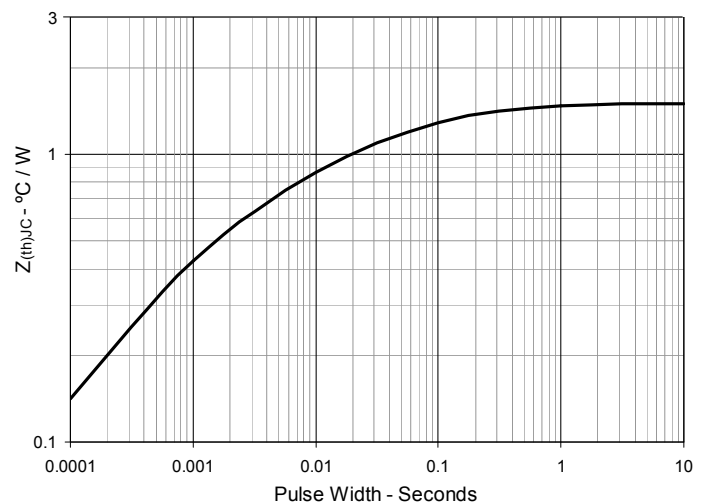



---

Disclaimer Notice - Information furnished is believed to be accurate and reliable. However, users should independently evaluate the suitability of and test each product selected for their own applications. Littelfuse products are not designed for, and may not be used in, all applications. Read complete Disclaimer Notice at [www.littelfuse.com/disclaimer-electronics](http://www.littelfuse.com/disclaimer-electronics).