

High Voltage IGBT

IXGH 32N170
IXGT 32N170

V_{CES} = 1700 V
I_{C25} = 75 A
V_{CE(sat)} = 3.3 V
t_{fi(typ)} = 250 ns

Preliminary Data Sheet

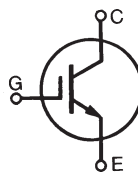

| Symbol | Test Conditions | Maximum Ratings | |
|---|---|--|-----|
| V _{CES} | T _J = 25°C to 150°C | 1700 | V |
| V _{CGR} | T _J = 25°C to 150°C; R _{GE} = 1 MΩ | 1700 | V |
| V _{GES} | Continuous | ±20 | V |
| V _{GEM} | Transient | ±30 | V |
| I _{C25} | T _C = 25°C | 75 | A |
| I _{C90} | T _C = 90°C | 32 | A |
| I _{CM} | T _C = 25°C, 1 ms | 200 | A |
| SSOA (RBSOA) | V _{GE} = 15 V, T _{VJ} = 125°C, R _G = 5 Ω Clamped inductive load | I _{CM} = 90 @ 0.8 V _{CES} | A |
| P _C | T _C = 25°C | 350 | W |
| T _J | | -55 ... +150 | °C |
| T _{JM} | | 150 | °C |
| T _{stg} | | -55 ... +150 | °C |
| Maximum Lead temperature for soldering 1.6 mm (0.062 in.) from case for 10 s | | 300 | °C |
| Maximum Tab temperature for soldering SMD devices for 10 s | | 260 | °C |
| M _d | Mounting torque (M3) | 1.13/10Nm/lb.in. | |
| Weight | | TO-247 AD | 6 g |
| | | TO-268 | 4 g |

TO-268 (IXGT)

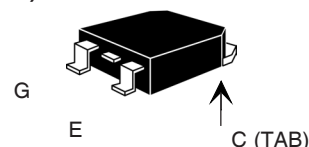

TO-247 AD (IXGH)

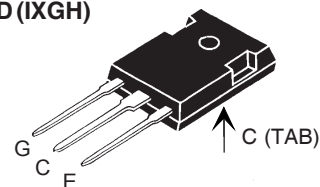

G = Gate, C = Collector,
E = Emitter, TAB = Collector

Features

- International standard packages
JEDEC TO-268 and
JEDEC TO-247 AD
- High current handling capability
- MOS Gate turn-on
- drive simplicity
- Rugged NPT structure
- Molding epoxies meet UL 94 V-0
flammability classification

Applications

- Capacitor discharge & pulser circuits
- AC motor speed control
- DC servo and robot drives
- DC choppers
- Uninterruptible power supplies (UPS)
- Switched-mode and resonant-mode
power supplies

Advantages

- High power density
- Suitable for surface mounting
- Easy to mount with 1 screw,
(isolated mounting screw hole)

| Symbol | Test Conditions | Characteristic Values (T _J = 25°C, unless otherwise specified) | | |
|----------------------------|--|--|------|---------|
| | | min. | typ. | max. |
| BV_{CES} | I _C = 250 μA, V _{GE} = 0 V | 1700 | | V |
| V_{GE(th)} | I _C = 250 μA, V _{CE} = V _{GE} | 3.0 | | V |
| I_{CES} | V _{CE} = 0.8 • V _{CES} | | | 50 μA |
| | V _{GE} = 0 V | | | 1 mA |
| I_{GES} | V _{CE} = 0 V, V _{GE} = ±20 V | | | ±100 nA |
| V_{CE(sat)} | I _C = I _{C90} , V _{GE} = 15 V | T _J = 25°C | 2.5 | 3.3 V |
| | | T _J = 125°C | 3.0 | V |

| Symbol | Test Conditions | Characteristic Values ($T_J = 25^\circ\text{C}$, unless otherwise specified) | | |
|--------------|---|---|------|----------|
| | | min. | typ. | max. |
| g_{fs} | $I_C = I_{C90}$; $V_{CE} = 10\text{ V}$, Pulse test, $t \leq 300\ \mu\text{s}$, duty cycle $\leq 2\%$ | 22 | 30 | S |
| $I_{C(ON)}$ | $V_{GE} = 10\text{ V}$, $V_{CE} = 10\text{ V}$ | | 120 | A |
| C_{ies} | $V_{CE} = 25\text{ V}$, $V_{GE} = 0\text{ V}$, $f = 1\text{ MHz}$ | | 3500 | pF |
| C_{oes} | | | 165 | pF |
| C_{res} | | | 40 | pF |
| Q_g | $I_C = I_{C90}$, $V_{GE} = 15\text{ V}$, $V_{CE} = 0.5 V_{CES}$ | | 155 | nC |
| Q_{ge} | | | 30 | nC |
| Q_{gc} | | | 51 | nC |
| $t_{d(on)}$ | Inductive load, $T_J = 25^\circ\text{C}$ $I_C = I_{C90}$, $V_{GE} = 15\text{ V}$ $V_{CE} = 0.6 V_{CES}$, $R_G = R_{off} = 2.7\ \Omega$ | | 45 | ns |
| t_{ri} | | | 38 | ns |
| $t_{d(off)}$ | | | 270 | 500 ns |
| t_{fi} | | | 250 | 500 ns |
| E_{off} | | | 11 | 20 mJ |
| $t_{d(on)}$ | Inductive load, $T_J = 125^\circ\text{C}$ $I_C = I_{C90}$, $V_{GE} = 15\text{ V}$ $V_{CE} = 0.6 V_{CES}$, $R_G = R_{off} = 2.7\ \Omega$ | | 48 | ns |
| t_{ri} | | | 42 | ns |
| E_{on} | | | 6.0 | mJ |
| $t_{d(off)}$ | | | 360 | ns |
| t_{fi} | | | 560 | ns |
| E_{off} | | 14 | mJ | |
| R_{thJC} | | | | 0.35 K/W |
| R_{thCK} | (TO-247) | | 0.25 | K/W |

Min Recommended Footprint

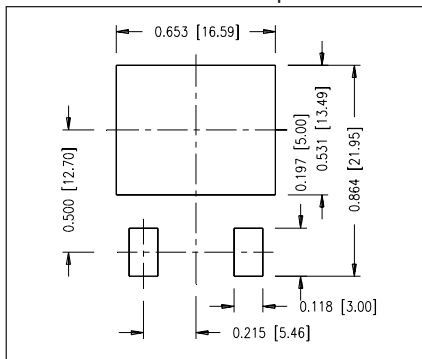

TO-247 AD Outline

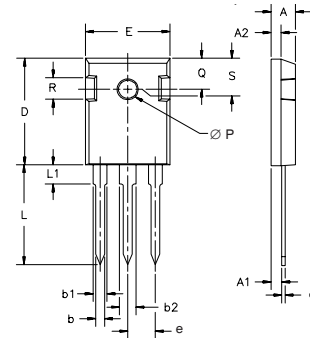

| Dim. | Millimeter | | Inches | |
|----------------|------------|-------|--------|-------|
| | Min. | Max. | Min. | Max. |
| A | 4.7 | 5.3 | .185 | .209 |
| A ₁ | 2.2 | 2.54 | .087 | .102 |
| A ₂ | 2.2 | 2.6 | .059 | .098 |
| b | 1.0 | 1.4 | .040 | .055 |
| b ₁ | 1.65 | 2.13 | .065 | .084 |
| b ₂ | 2.87 | 3.12 | .113 | .123 |
| C | .4 | .8 | .016 | .031 |
| D | 20.80 | 21.46 | .819 | .845 |
| E | 15.75 | 16.26 | .610 | .640 |
| e | 5.20 | 5.72 | 0.205 | 0.225 |
| L | 19.81 | 20.32 | .780 | .800 |
| L1 | | 4.50 | | .177 |
| ØP | 3.55 | 3.65 | .140 | .144 |
| Q | 5.89 | 6.40 | 0.232 | 0.252 |
| R | 4.32 | 5.49 | .170 | .216 |
| S | 6.15 | BSC | .242 | BSC |

TO-268 Outline

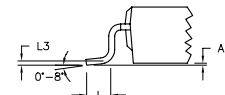
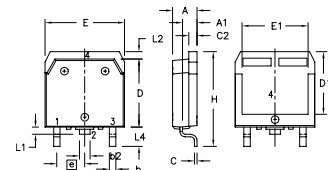

| Dim. | Millimeter | | Inches | |
|----------------|------------|-------|--------|------|
| | Min. | Max. | Min. | Max. |
| A | 4.9 | 5.1 | .193 | .201 |
| A ₁ | 2.7 | 2.9 | .106 | .114 |
| A ₂ | .02 | .25 | .001 | .010 |
| b | 1.15 | 1.45 | .045 | .057 |
| b ₂ | 1.9 | 2.1 | .75 | .83 |
| C | .4 | .65 | .016 | .026 |
| D | 13.80 | 14.00 | .543 | .551 |
| E | 15.85 | 16.05 | .624 | .632 |
| E ₁ | 13.3 | 13.6 | .524 | .535 |
| e | 5.45 | BSC | .215 | BSC |
| H | 18.70 | 19.10 | .736 | .752 |
| L | 2.40 | 2.70 | .094 | .106 |
| L1 | 1.20 | 1.40 | .047 | .055 |
| L2 | 1.00 | 1.15 | .039 | .045 |
| L3 | | 0.25 | | .010 |
| L4 | 3.80 | 4.10 | .150 | .161 |

IXYS reserves the right to change limits, test conditions, and dimensions.

IXYS MOSFETs and IGBTs are covered by one or more of the following U.S. patents:

4,835,592 4,881,106 5,017,508 5,049,961 5,187,117 5,486,715 6,306,728B1 6,259,123B1 6,306,728B1
4,850,072 4,931,844 5,034,796 5,063,307 5,237,481 5,381,025 6,404,065B1 6,162,665 6,534,343 6,583,505

Fig. 1. Output Characteristics @ 25 Deg. C

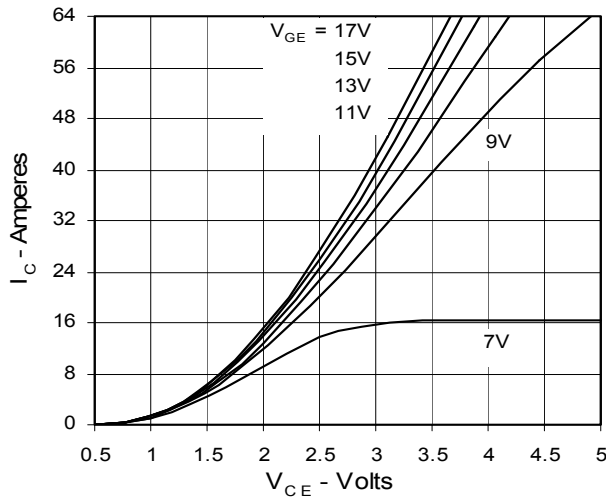

Fig. 2. Extended Output Characteristics @ 25 deg. C

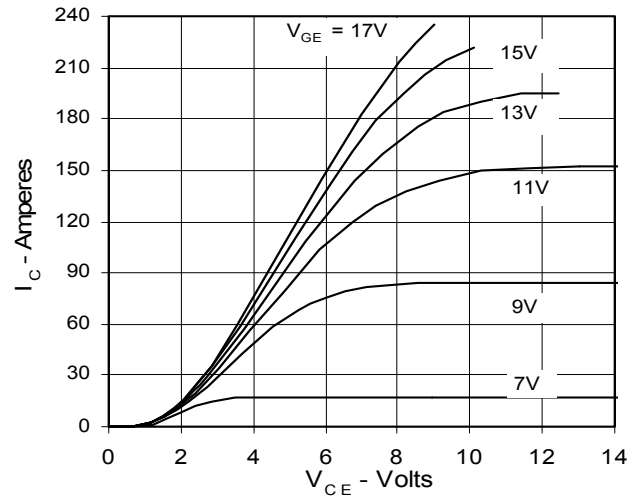

Fig. 3. Output Characteristics @ 125 Deg. C

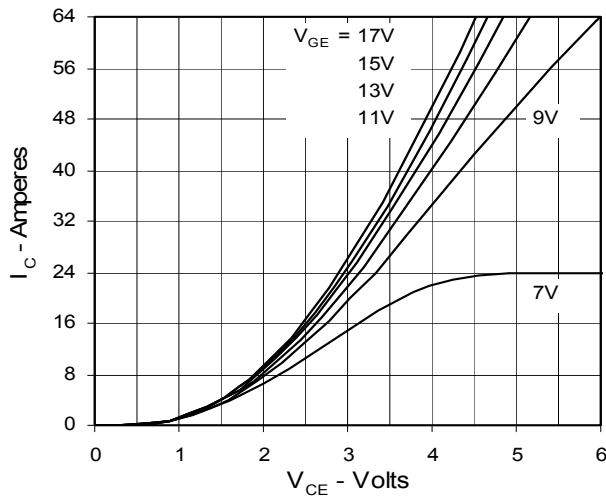

Fig. 4. Dependence of $V_{CE(sat)}$ on Temperature

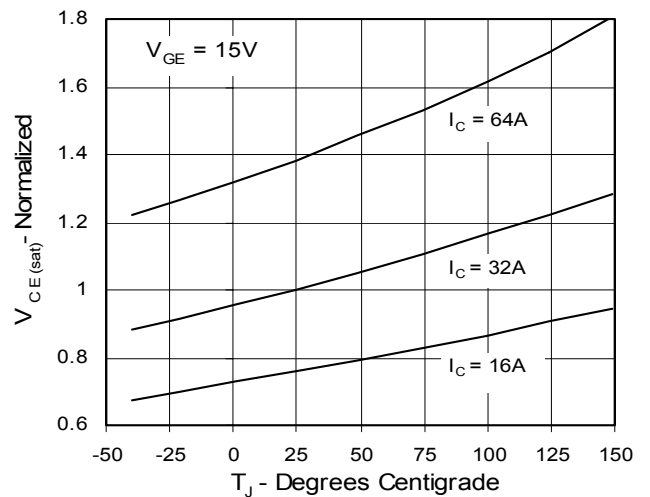

Fig. 5. Collector-to-Emitter Voltage vs. Gate-to-Emitter voltage

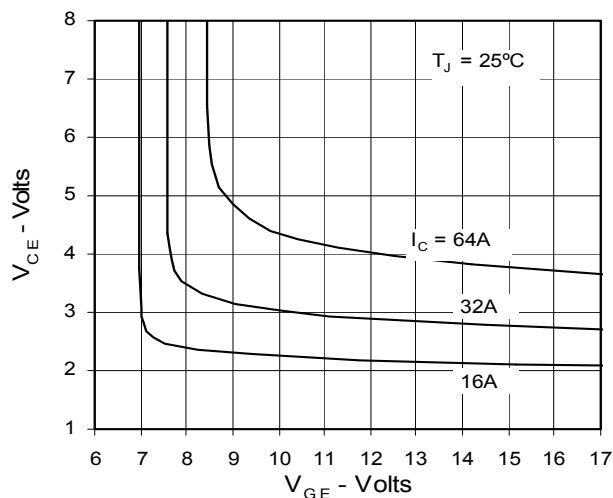

Fig. 6. Input Admittance

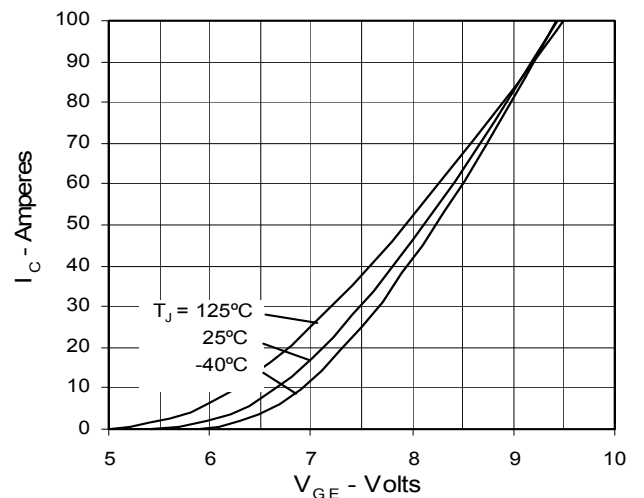

Fig. 7. Transconductance

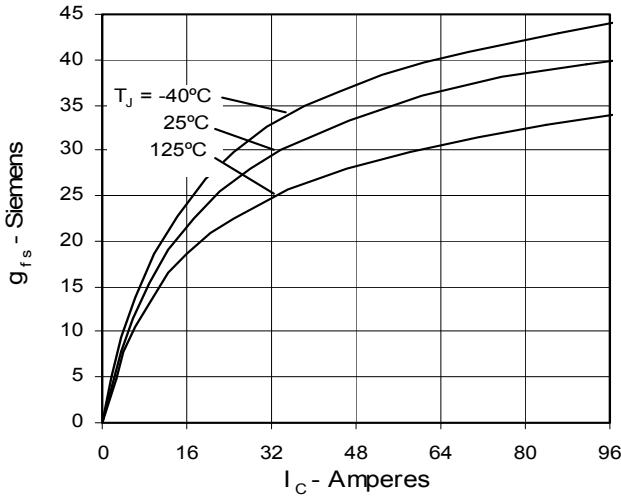

Fig. 8. Dependence of E_{off} on R_G

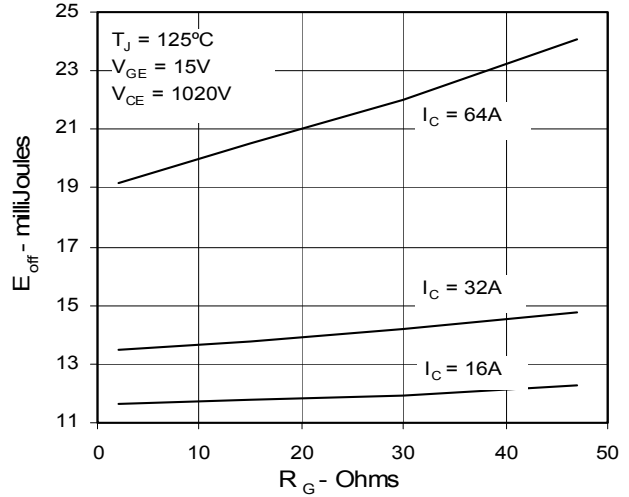

Fig. 9. Dependence of E_{off} on I_C

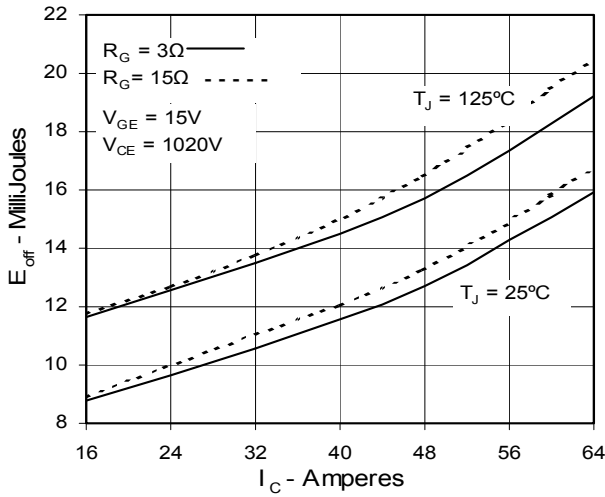

Fig. 10. Dependence of E_{off} on Temperature

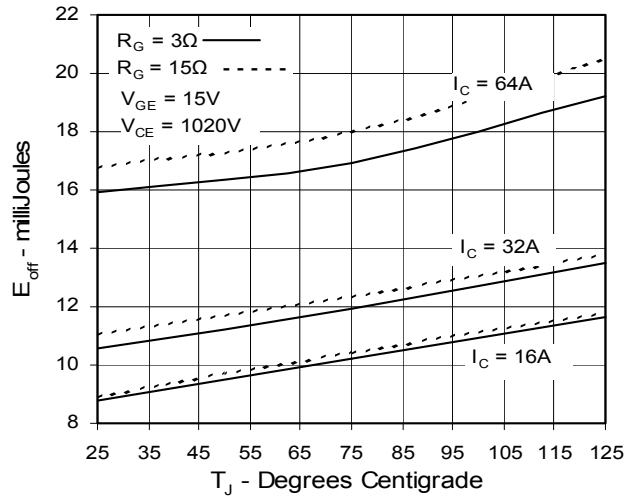

Fig. 11. Gate Charge

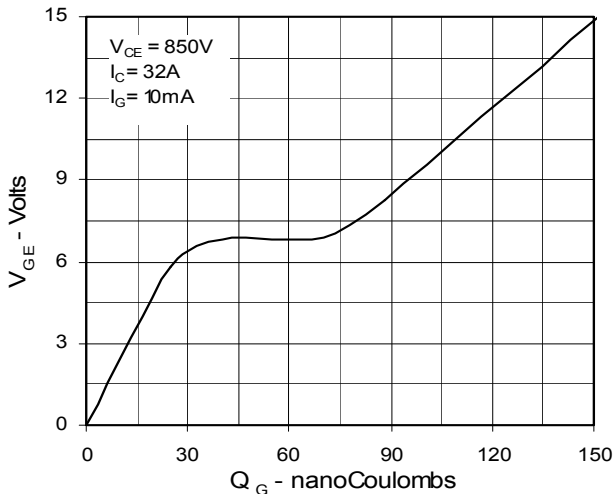
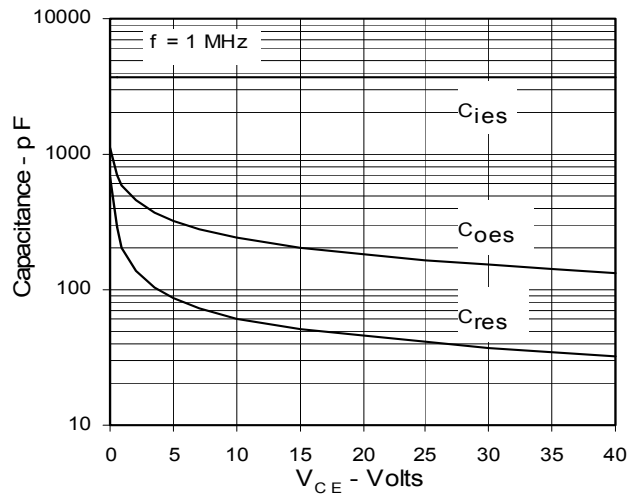

Fig. 12. Capacitance



IXYS reserves the right to change limits, test conditions, and dimensions.

IXYS MOSFETs and IGBTs are covered by one or more of the following U.S. patents: 4,835,592 4,881,106 5,017,508 5,049,961 5,187,117 5,486,715 6,306,728B1 6,259,123B1 6,306,728B1 4,850,072 4,931,844 5,034,796 5,063,307 5,237,481 5,381,025 6,404,065B1 6,162,665 6,534,343 6,583,505

Fig. 13. Maximum Transient Thermal Resistance

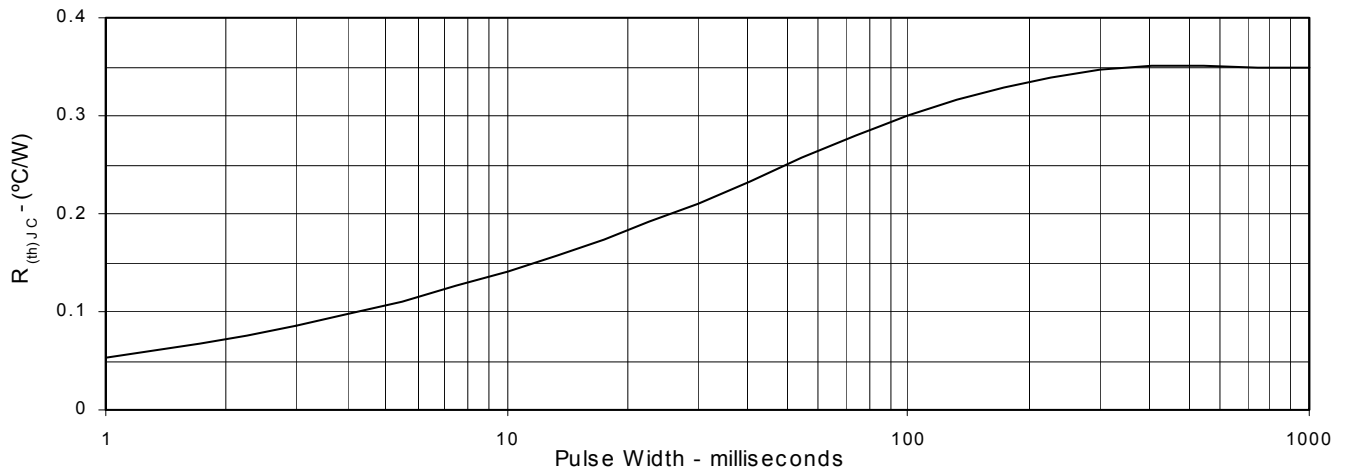



Disclaimer Notice - Information furnished is believed to be accurate and reliable. However, users should independently evaluate the suitability of and test each product selected for their own applications. Littelfuse products are not designed for, and may not be used in, all applications. Read complete Disclaimer Notice at www.littelfuse.com/disclaimer-electronics.