

# High Voltage IGBT

# IXGT6N170 IXGH6N170

$V_{CES} = 1700V$   
 $I_{C90} = 6A$   
 $V_{CE(sat)} \leq 4.0V$   
 $t_{fi(typ)} = 290ns$

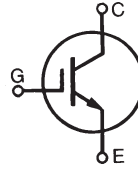

Symbol	Test Conditions	Maximum Ratings	
$V_{CES}$	$T_C = 25^\circ C$ to $150^\circ C$	1700	V
$V_{CGR}$	$T_J = 25^\circ C$ to $150^\circ C$ , $R_{GE} = 1M\Omega$	1700	V
$V_{GES}$	Continuous	$\pm 20$	V
$V_{GEM}$	Transient	$\pm 30$	V
$I_{C25}$	$T_C = 25^\circ C$	12	A
$I_{C90}$	$T_C = 90^\circ C$	6	A
$I_{CM}$	$T_C = 25^\circ C$ , 1ms	24	A
<b>SSOA</b>	$V_{GE} = 15V$ , $T_{VJ} = 125^\circ C$ , $R_G = 33\Omega$	$I_{CM} = 12$	A
<b>(RBSOA)</b>	Clamped Inductive Load	@ $0.8 \cdot V_{CES}$	
$P_C$	$T_C = 25^\circ C$	75	W
$T_J$		- 55 ... +150	$^\circ C$
$T_{JM}$		150	$^\circ C$
$T_{stg}$		- 55 ... +150	$^\circ C$
$T_L$	Maximum Lead Temperature for Soldering	300	$^\circ C$
$T_{SOLD}$	1.6 mm (0.062in.) from Case for 10s	260	$^\circ C$
$M_d$	Mounting Torque (TO-247)	1.13/10	Nm/lb.in.
<b>Weight</b>	TO-268	4	g
	TO-247	6	g

TO-268 (IXGT)

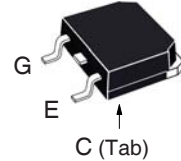

TO-247 (IXGH)

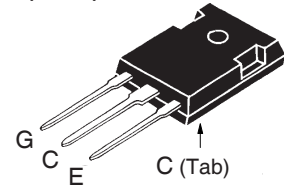

G = Gate      C = Collector  
 E = Emitter    Tab = Collector

## Features

- International Standard Packages
- High Voltage Package

## Advantages

- High Power Density
- Low Gate Drive Requirement

## Applications

- Capacitor Discharge & Pulse Circuits
- Uninterruptible Power Supplies (UPS)
- Motor Drives
- DC Servo & Robot Drives
- DC Choppers
- Switched-Mode & Resonant-Mode Power Supplies

Symbol	Test Conditions ( $T_J = 25^\circ C$ Unless Otherwise Specified)	Characteristic Values		
		Min.	Typ.	Max.
$BV_{CES}$	$I_C = 250\mu A$ , $V_{GE} = 0V$	1700		V
$V_{GE(th)}$	$I_C = 250\mu A$ , $V_{CE} = V_{GE}$	3.0		V
$I_{CES}$	$V_{CE} = 0.8 \cdot V_{CES}$ , $V_{GE} = 0V$ $T_J = 125^\circ C$			10 $\mu A$ 100 $\mu A$
$I_{GES}$	$V_{CE} = 0V$ , $V_{GE} = \pm 20V$			$\pm 100$ nA
$V_{CE(sat)}$	$I_C = I_{C90}$ , $V_{GE} = 15V$ , Note 1 $T_J = 125^\circ C$		3.0 4.0	4.0 V

Symbol	Test Conditions ( $T_J = 25^\circ\text{C}$ , Unless Otherwise Specified)	Characteristic Values			
		Min.	Typ.	Max.	
$g_{fs}$	$I_C = 6\text{A}$ , $V_{CE} = 10\text{V}$ , Note 1	3.0	4.5	S	
$I_{C(ON)}$	$V_{GE} = 15\text{V}$ , $V_{CE} = 10\text{V}$		28	A	
$C_{ies}$	$V_{CE} = 25\text{V}$ , $V_{GE} = 0\text{V}$ , $f = 1\text{MHz}$		330	pF	
$C_{oes}$			23	pF	
$C_{res}$			6	pF	
$Q_g$	$I_C = 6\text{A}$ , $V_{GE} = 15\text{V}$ , $V_{CE} = 0.5 \cdot V_{CES}$		20.0	nC	
$Q_{ge}$			3.6	nC	
$Q_{gc}$			8.0	nC	
$t_{d(on)}$	<b>Inductive load, <math>T_J = 25^\circ\text{C}</math></b> $I_C = 6\text{A}$ , $V_{GE} = 15\text{V}$ $V_{CE} = 0.8 \cdot V_{CES}$ , $R_G = 33\Omega$ Note 2		40	ns	
$t_{ri}$			36	ns	
$t_{d(off)}$			250	500	ns
$t_{fi}$			290	500	ns
$E_{off}$			1.5	2.5	mJ
$t_{d(on)}$	<b>Inductive load, <math>T_J = 125^\circ\text{C}</math></b> $I_C = 6\text{A}$ , $V_{GE} = 15\text{V}$ $V_{CE} = 0.8 \cdot V_{CES}$ , $R_G = 33\Omega$ Note 2		45	ns	
$t_{ri}$			40	ns	
$E_{on}$			0.5	mJ	
$t_{d(off)}$			300	ns	
$t_{fi}$			300	ns	
$E_{off}$		2.0	mJ		
$R_{thJC}$	TO-247			1.65 $^\circ\text{C/W}$	
$R_{thCK}$			0.21	$^\circ\text{C/W}$	

**Notes:**

1. Pulse test,  $t \leq 300\mu\text{s}$ , duty cycle,  $d \leq 2\%$ .
2. Switching times & energy losses may increase for higher  $V_{CE}$  (clamp),  $T_J$  or  $R_G$ .

**TO-268 Outline**

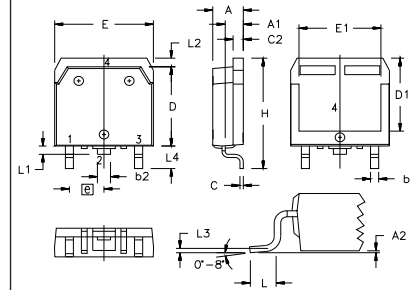

Terminals: 1 - Gate, 2,4 - Collector, 3 - Emitter

SYM	INCHES		MILLIMETERS	
	MIN	MAX	MIN	MAX
A	.193	.201	4.90	5.10
A1	.106	.114	2.70	2.90
A2	.001	.010	0.02	0.25
b	.045	.057	1.15	1.45
b2	.075	.083	1.90	2.10
C	.016	.026	0.40	0.65
C2	.057	.063	1.45	1.60
D	.543	.551	13.80	14.00
D1	.488	.500	12.40	12.70
E	.624	.632	15.85	16.05
E 1	.524	.535	13.30	13.60
e	.215 BSC		5.45 BSC	
H	.736	.752	18.70	19.10
L	.094	.106	2.40	2.70
L1	.047	.055	1.20	1.40
L2	.039	.045	1.00	1.15
L3	.010 BSC		0.25 BSC	
L4	.150	.161	3.80	4.10

**TO-247 Outline**

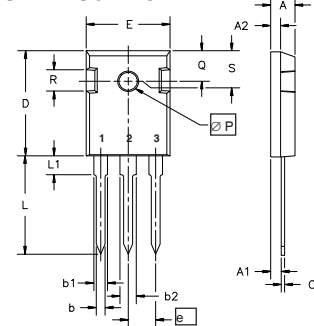

Terminals: 1 - Gate, 2 - Collector, 3 - Emitter

Dim.	Millimeter		Inches	
	Min.	Max.	Min.	Max.
A	4.7	5.3	.185	.209
A <sub>1</sub>	2.2	2.54	.087	.102
A <sub>2</sub>	2.2	2.6	.059	.098
b	1.0	1.4	.040	.055
b <sub>1</sub>	1.65	2.13	.065	.084
b <sub>2</sub>	2.87	3.12	.113	.123
C	.4	.8	.016	.031
D	20.80	21.46	.819	.845
E	15.75	16.26	.610	.640
e	5.20	5.72	0.205	0.225
L	19.81	20.32	.780	.800
L1		4.50		.177
∅P	3.55	3.65	.140	.144
Q	5.89	6.40	0.232	0.252
R	4.32	5.49	.170	.216
S		6.15 BSC		242 BSC

IXYS Reserves the Right to Change Limits, Test Conditions, and Dimensions.

IXYS MOSFETs and IGBTs are covered by one or more of the following U.S. patents:

4,835,592	4,931,844	5,049,961	5,237,481	6,162,665	6,404,065 B1	6,683,344	6,727,585	7,005,734 B2	7,157,338B2
4,860,072	5,017,508	5,063,307	5,381,025	6,259,123 B1	6,534,343	6,710,405 B2	6,759,692	7,063,975 B2	
4,881,106	5,034,796	5,187,117	5,486,715	6,306,728 B1	6,583,505	6,710,463	6,771,478 B2	7,071,537	

**Fig. 1. Output Characteristics @  $T_J = 25^\circ\text{C}$**

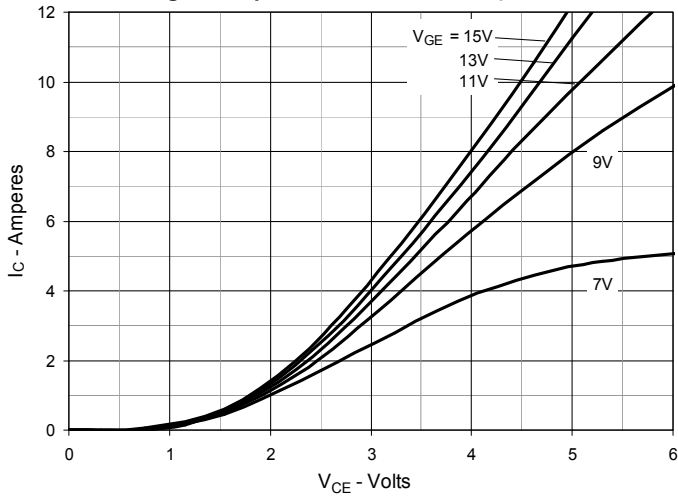

**Fig. 2. Extended Output Characteristics @  $T_J = 25^\circ\text{C}$**

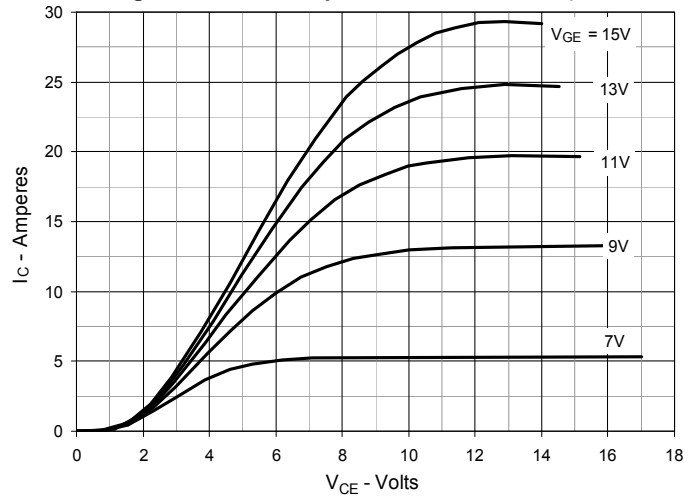

**Fig. 3. Output Characteristics @  $T_J = 125^\circ\text{C}$**

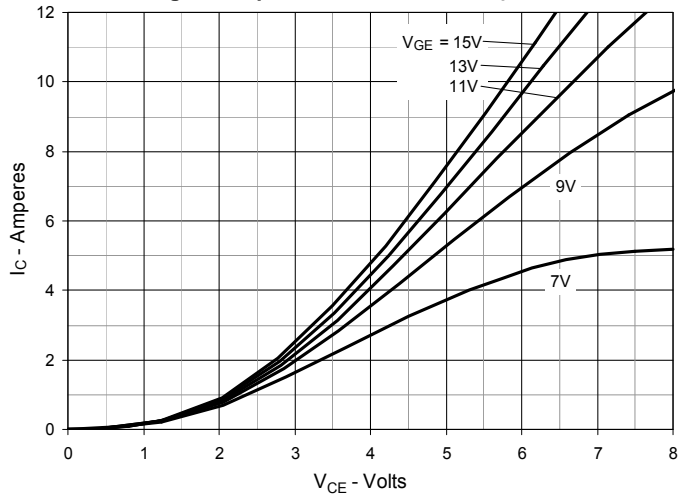

**Fig. 4. Dependence of  $V_{CE(sat)}$  on Junction Temperature**

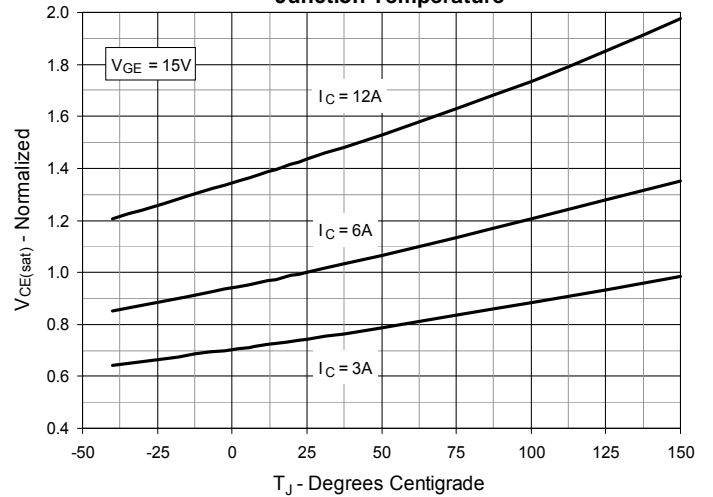

**Fig. 5. Input Admittance**

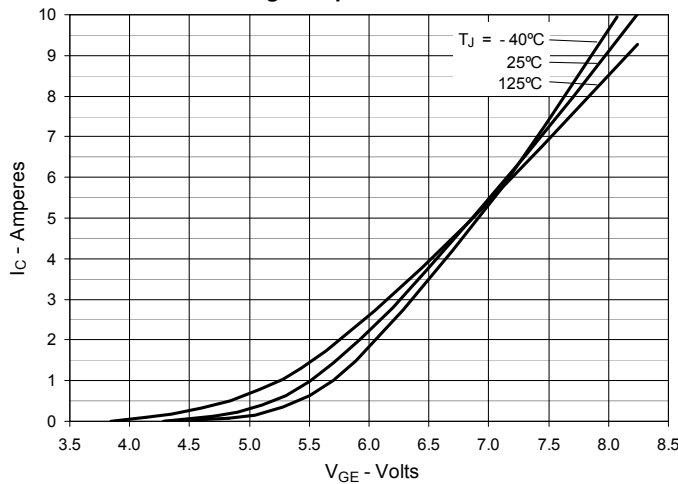

**Fig. 6. Transconductance**

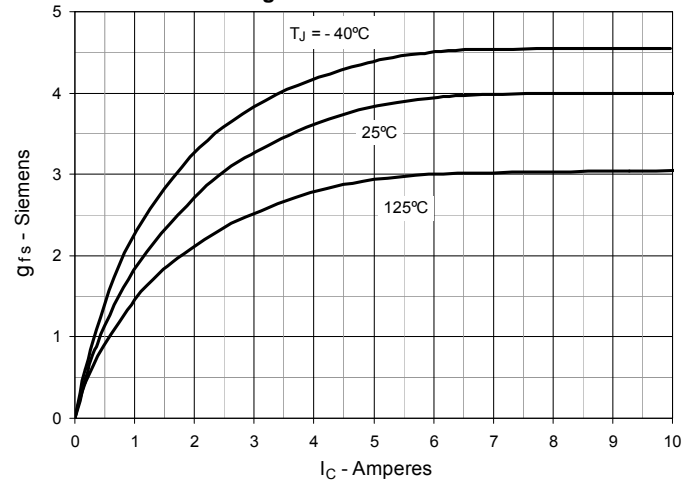

**Fig. 7. Gate Charge**

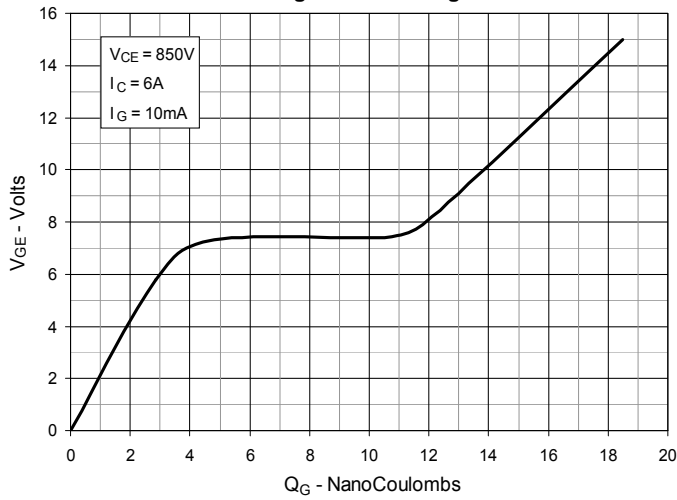

**Fig. 8. Capacitance**

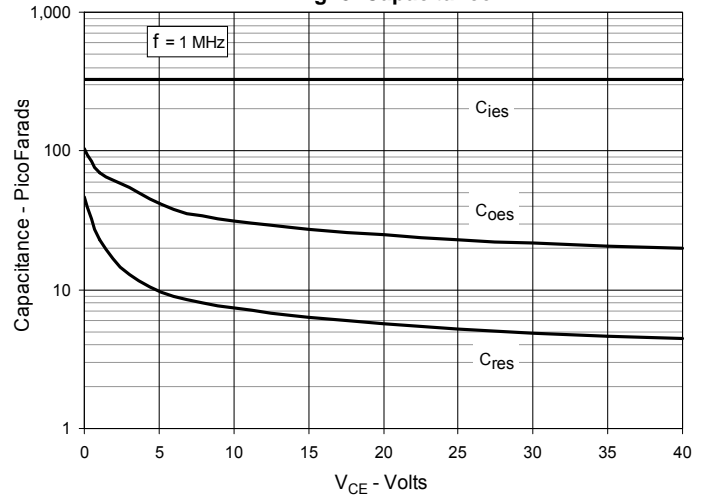

**Fig. 9. Reverse-Bias Safe Operating Area**

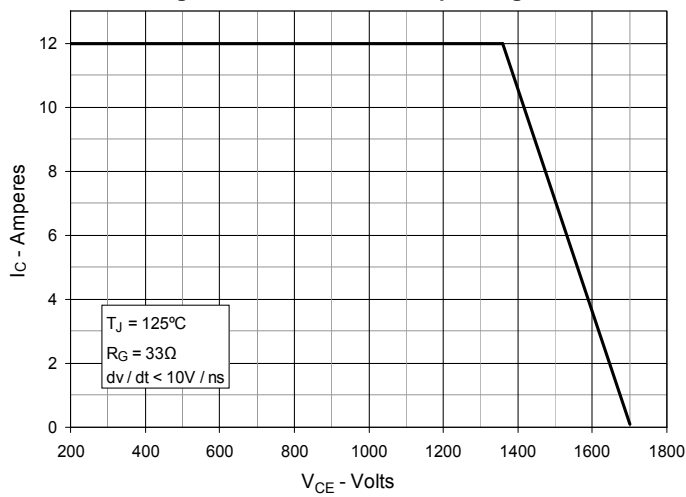

**Fig. 10. Maximum Transient Thermal Impedance**

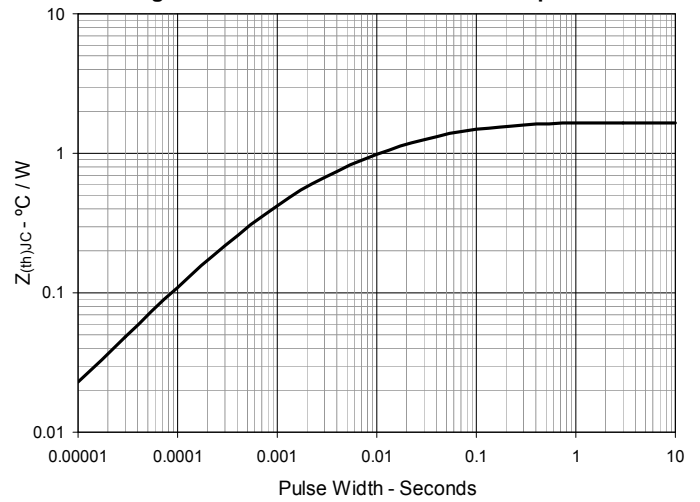

**Fig. 11. Cauer Thermal Network**

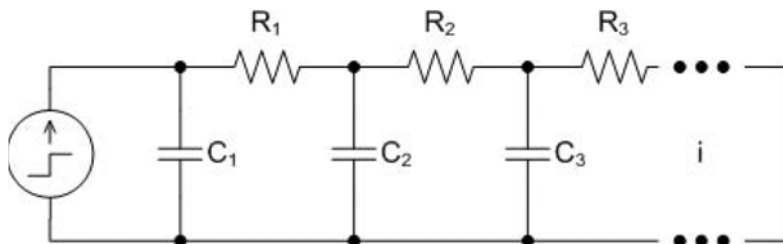

i	$R_i$ ( $^\circ\text{C/W}$ )	$C_i$ ( $\text{J}/^\circ\text{C}$ )
1	0.11615	0.0019257
2	0.29930	0.0016574
3	0.26377	0.0262960



---

Disclaimer Notice - Information furnished is believed to be accurate and reliable. However, users should independently evaluate the suitability of and test each product selected for their own applications. Littelfuse products are not designed for, and may not be used in, all applications. Read complete Disclaimer Notice at [www.littelfuse.com/disclaimer-electronics](http://www.littelfuse.com/disclaimer-electronics).