

High Voltage IGBT For Capacitor Discharge Applications

IXGF30N400

(Electrically Isolated Tab)

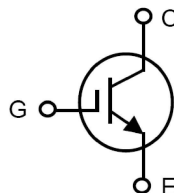

$$V_{CES} = 4000V$$

$$I_{C25} = 30A$$

$$V_{CE(sat)} \leq 3.1V$$

Symbol	Test Conditions	Maximum Ratings	
V_{CES}	$T_J = 25^\circ C$ to $150^\circ C$	4000	V
V_{GES}	Continuous	± 20	V
V_{GEM}	Transient	± 30	V
I_{C25}	$T_C = 25^\circ C$	30	A
I_{C110}	$T_C = 110^\circ C$	15	A
I_{CM}	$T_C = 25^\circ C, V_{GE} = 20V, 1ms$	360	A
SSOA	$V_{GE} = 20V, T_{VJ} = 125^\circ C, R_G = 2\Omega$	$I_{CM} = 300$	A
(RBSOA)	Clamped Inductive Load	$V_{CE} \leq 0.8 \cdot V_{CES}$	
P_C	$T_C = 25^\circ C$	160	W
T_J		-55 ... +150	$^\circ C$
T_{JM}		150	$^\circ C$
T_{stg}		-55 ... +150	$^\circ C$
T_L	Maximum Lead Temperature for Soldering	300	$^\circ C$
T_{SOLD}	1.6 mm (0.062in.) from Case for 10s	260	$^\circ C$
F_C	Mounting Force	20..120 / 4.5..27	Nm/lb.in.
V_{ISOL}	50/60Hz, 1 minute	4000	V~
Weight		5	g

ISOPLUS i4-Pak™

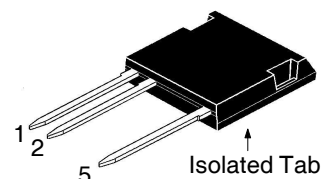

1 = Gate 5 = Collector
2 = Emitter

Features

- Silicon Chip on Direct-Copper Bond (DCB) Substrate
- Isolated Mounting Surface
- 4000V Electrical Isolation
- High Peak Current Capability
- Low Saturation Voltage
- Molding Epoxies Meet UL 94 V-0 Flammability Classification

Advantages

- High Power Density
- Easy to Mount

Applications

- Capacitor Discharge
- Pulsar Circuits

Symbol	Test Conditions ($T_J = 25^\circ C$, Unless Otherwise Specified)	Characteristic Values		
		Min.	Typ.	Max.
BV_{CES}	$I_C = 250\mu A, V_{GE} = 0V$	4000		V
$V_{GE(th)}$	$I_C = 250\mu A, V_{CE} = V_{GE}$	3.0		5.0 V
I_{CES}	$V_{CE} = 0.8 \cdot V_{CES}, V_{GE} = 0V$ Note 2, $T_J = 100^\circ C$			50 μA 3 mA
I_{GES}	$V_{CE} = 0V, V_{GE} = \pm 20V$			± 200 nA
$V_{CE(sat)}$	$I_C = 30A, V_{GE} = 15V, \text{Note 1}$ $I_C = 90A$			3.1 V 5.2 V

Symbol	Test Conditions ($T_J = 25^\circ\text{C}$, Unless Otherwise Specified)	Characteristic Values		
		Min.	Typ.	Max.
g_{fs}	$I_C = 30\text{A}$, $V_{CE} = 10\text{V}$, Note 1	14	23	S
$I_{C(ON)}$	$V_{GE} = 15\text{V}$, $V_{CE} = 20\text{V}$, Note 1		360	A
C_{ies}	$V_{CE} = 25\text{V}$, $V_{GE} = 0\text{V}$, $f = 1\text{MHz}$		3040	pF
C_{oes}			95	pF
C_{res}			30	pF
Q_g	$I_C = 30\text{A}$, $V_{GE} = 15\text{V}$, $V_{CE} = 600\text{V}$		135	nC
Q_{ge}			22	nC
Q_{gc}			50	nC
$t_{d(on)}$	Resistive Switching Times $I_C = 30\text{A}$, $V_{GE} = 15\text{V}$, $V_{CE} = 1250\text{V}$, $R_G = 2\Omega$		55	ns
t_r			146	ns
$t_{d(off)}$			210	ns
t_f			514	ns
R_{thJC}			0.78	$^\circ\text{C/W}$
R_{thCS}		0.15		$^\circ\text{C/W}$
R_{thJA}		30		$^\circ\text{C/W}$

Notes:

1. Pulse test, $t < 300\mu\text{s}$, duty cycle, $d < 2\%$.
2. Device must be heatsunk for high-temperature leakage current measurements to avoid thermal runaway.

IXYS Reserves the Right to Change Limits, Test Conditions, and Dimensions.

IXYS MOSFETs and IGBTs are covered by one or more of the following U.S. patents:

4,835,592	4,931,844	5,049,961	5,237,481	6,162,665	6,404,065 B1	6,683,344	6,727,585	7,005,734 B2	7,157,338B2
4,860,072	5,017,508	5,063,307	5,381,025	6,259,123 B1	6,534,343	6,710,405 B2	6,759,692	7,063,975 B2	
4,881,106	5,034,796	5,187,117	5,486,715	6,306,728 B1	6,583,505	6,710,463	6,771,478 B2	7,071,537	

Fig. 1. Output Characteristics @ $T_J = 25^\circ\text{C}$

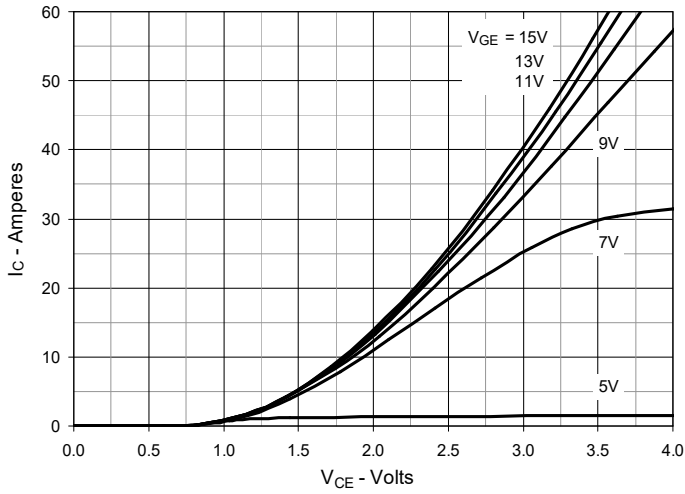

Fig. 2. Extended Output Characteristics @ $T_J = 25^\circ\text{C}$

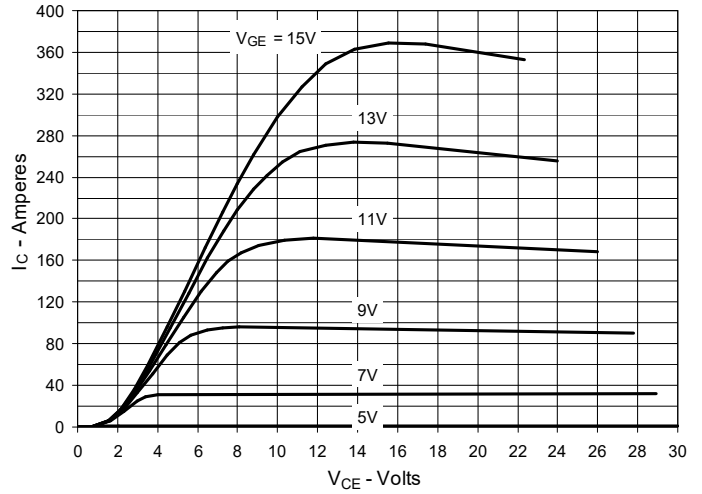

Fig. 3. Output Characteristics @ $T_J = 125^\circ\text{C}$

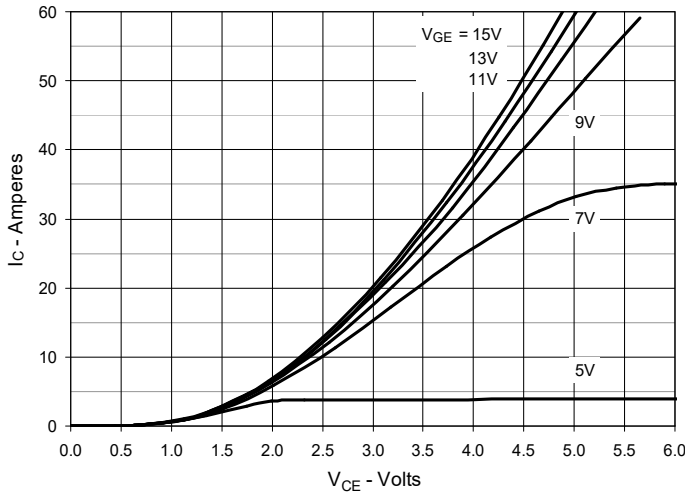

Fig. 4. Dependence of $V_{CE(sat)}$ on Junction Temperature

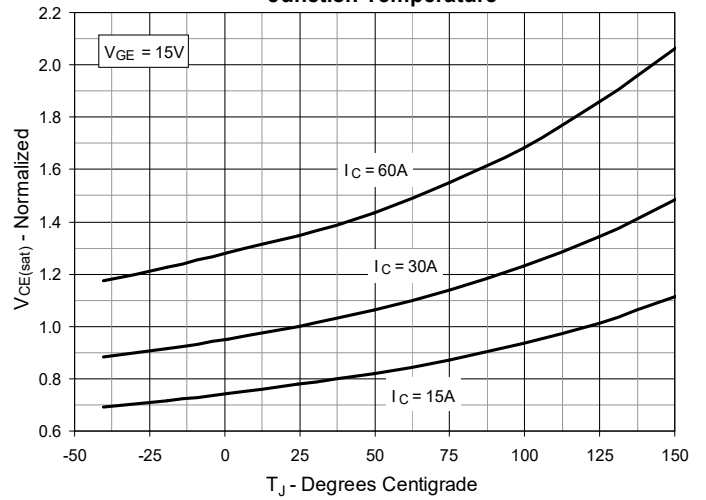

Fig. 5. Collector-to-Emitter Voltage vs. Gate-to-Emitter Voltage

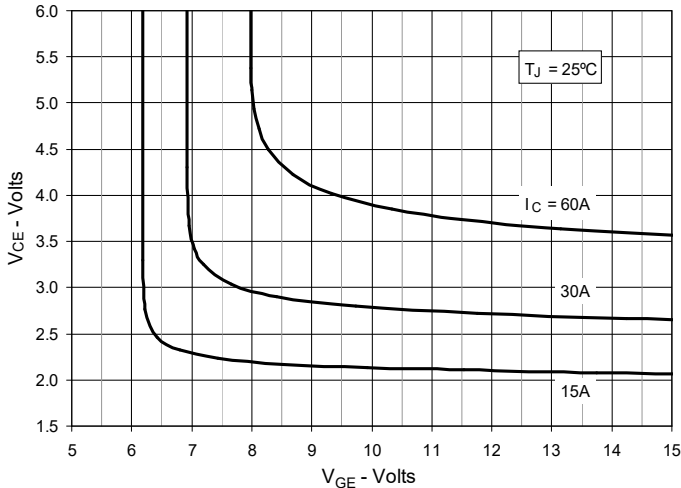

Fig. 6. Input Admittance

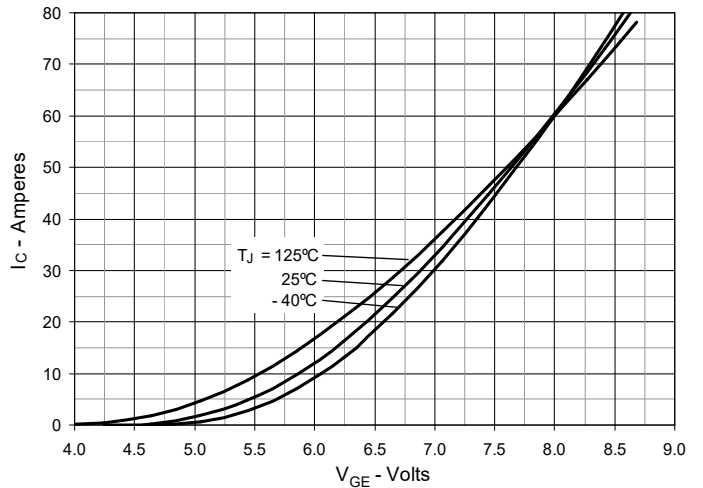

Fig. 7. Transconductance

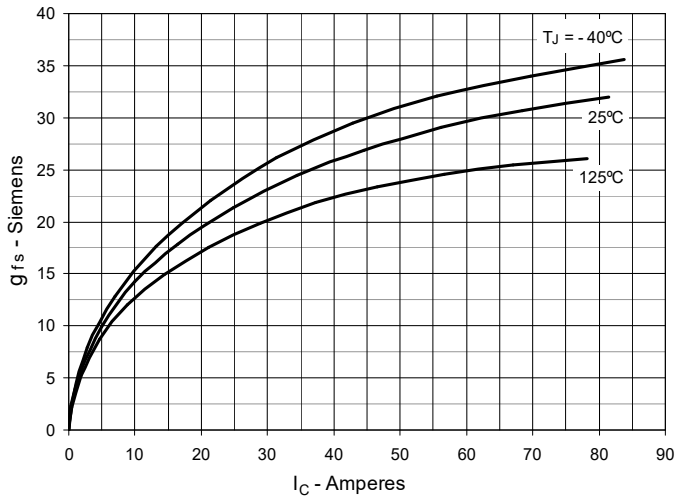

Fig. 8. Gate Charge

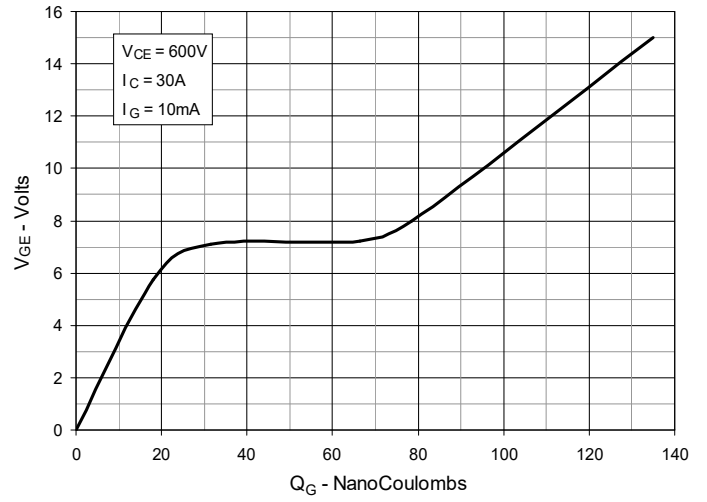

Fig. 9. Reverse-Bias Safe Operating Area

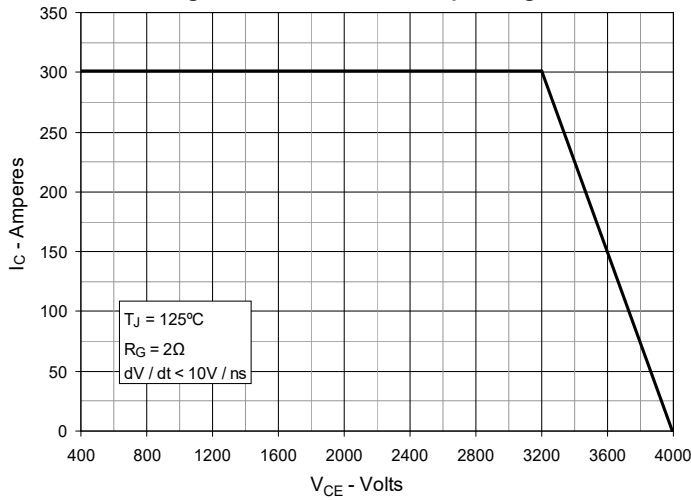

Fig. 10. Capacitance

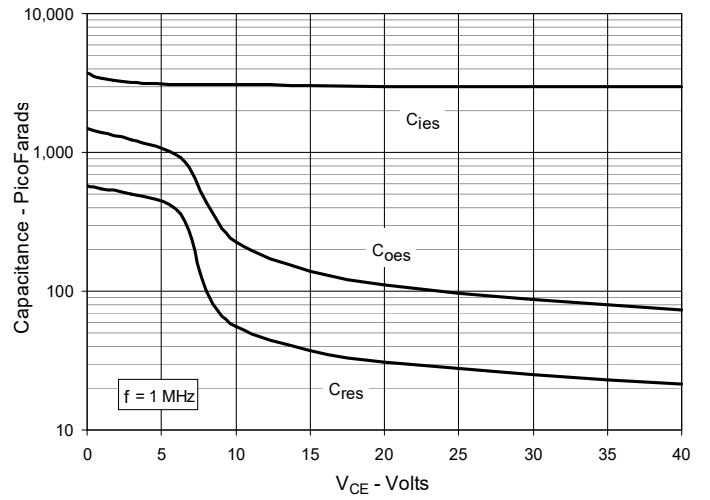
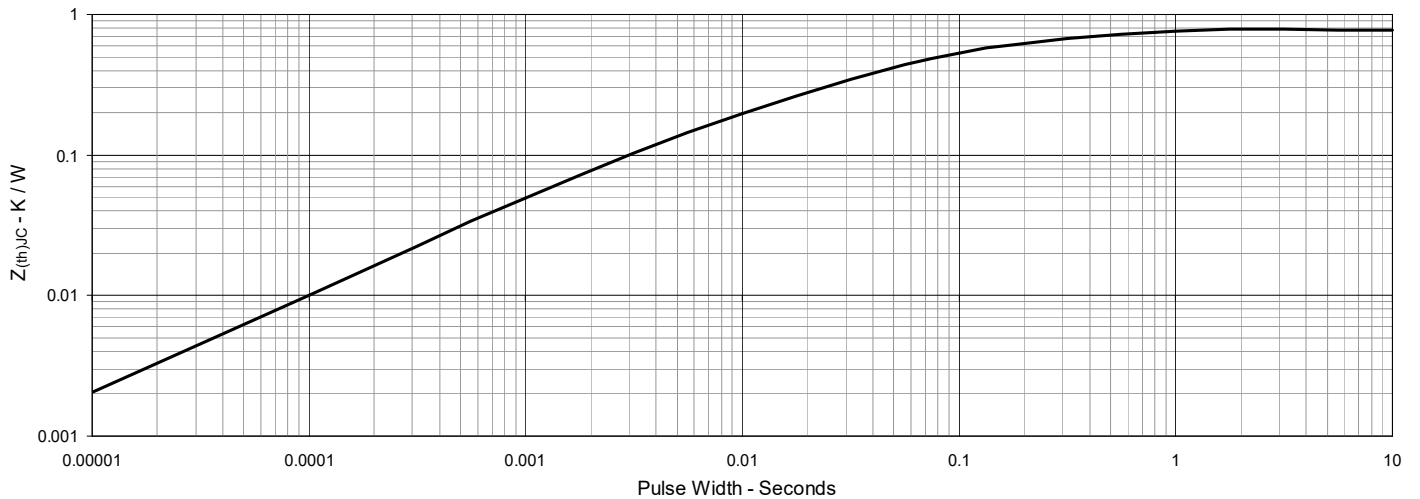
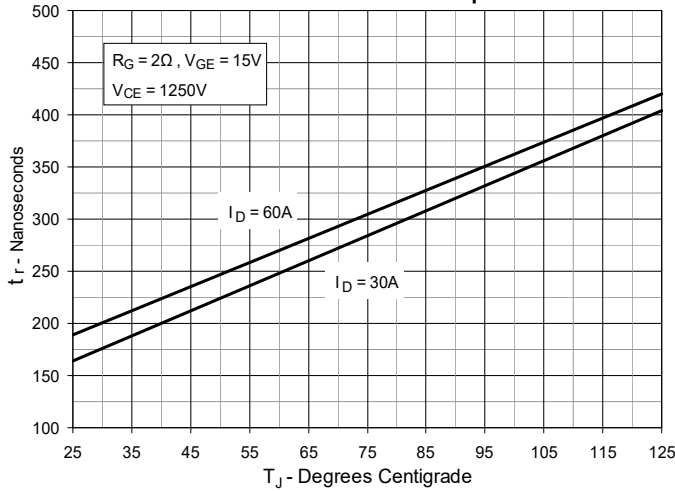

Fig. 11. Maximum Transient Thermal Impedance



**Fig. 12. Resistive Turn-on
Rise Time vs. Junction Temperature**



**Fig. 13. Resistive Turn-on
Rise Time vs. Drain Current**

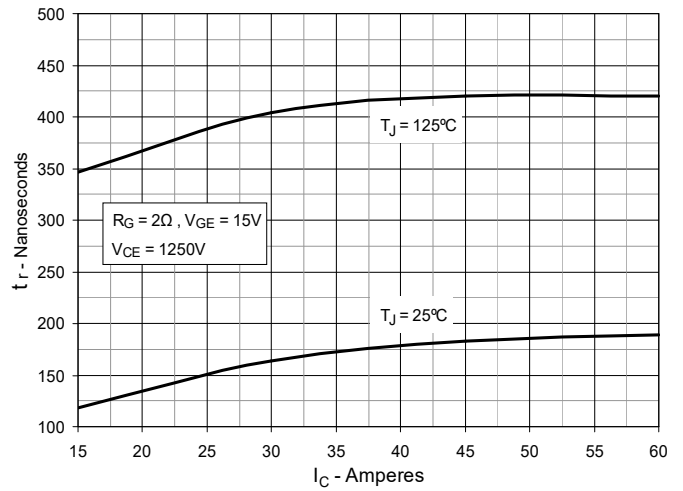

**Fig. 14. Resistive Turn-on
Switching Times vs. Gate Resistance**

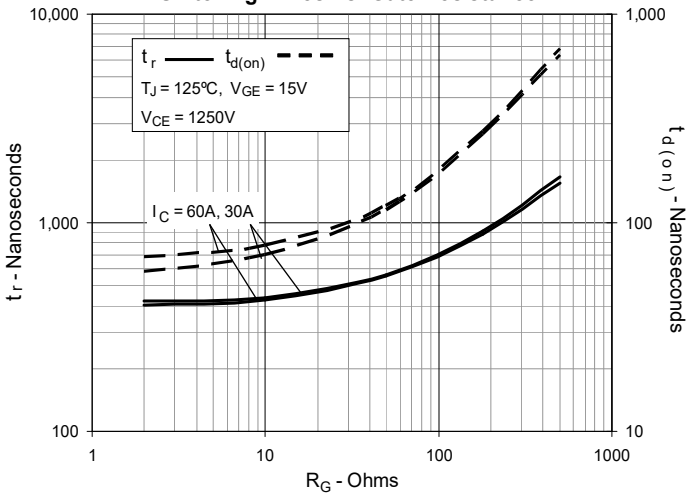

**Fig. 15. Resistive Turn-off
Switching Times vs. Junction Temperature**

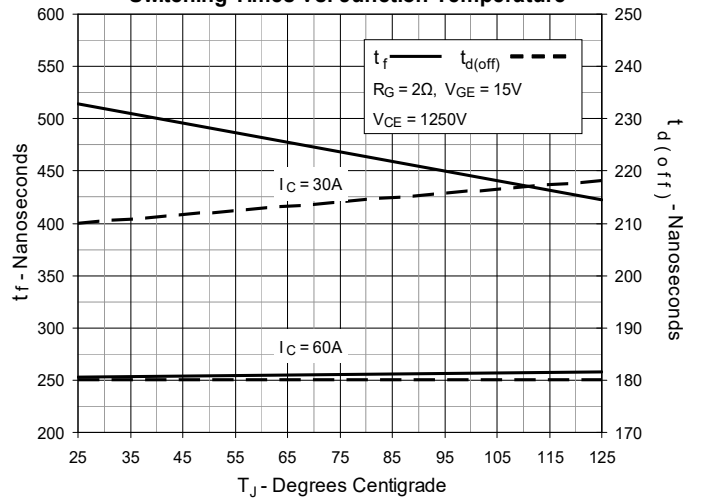

**Fig. 16. Resistive Turn-off
Switching Times vs. Drain Current**

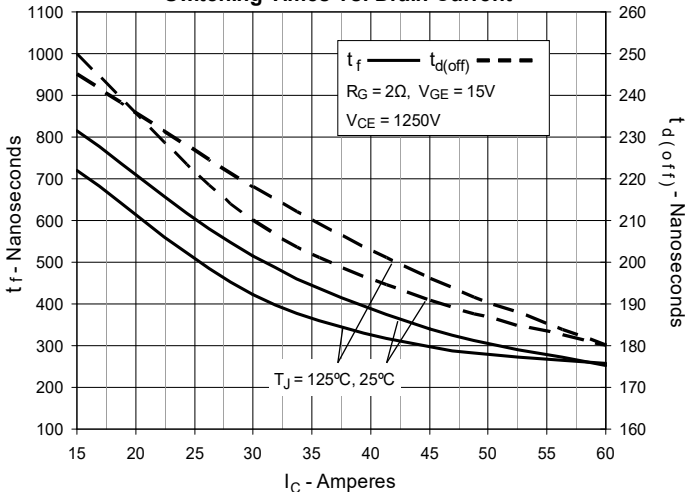

**Fig. 17. Resistive Turn-off
Switching Times vs. Gate Resistance**

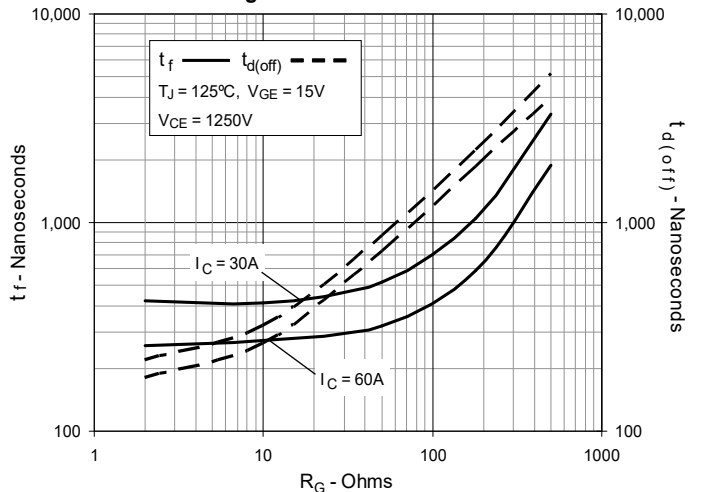

ISOPLUS I4-Pak™ (HV) Outline

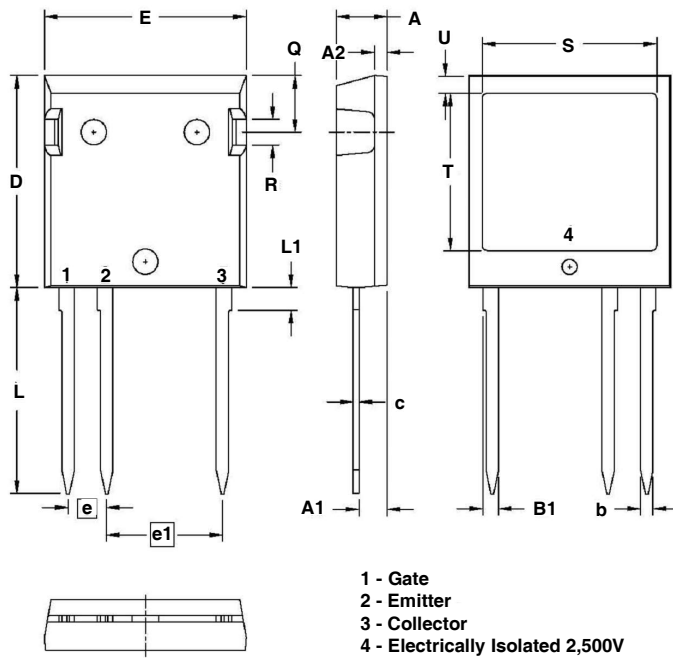

SYM	INCHES		MILLIMETERS	
	MIN	MAX	MIN	MAX
A	.190	.205	4.83	5.21
A1	.102	.118	2.59	3.00
A2	.046	.085	1.17	2.16
b	.045	.055	1.14	1.40
b1	.058	.068	1.47	1.73
C	.020	.029	0.51	0.74
D	.819	.840	20.80	21.34
E	.770	.799	19.56	20.29
e	.150 BSC		3.81 BSC	
e1	.450 BSC		11.43 BSC	
L	.780	.840	19.81	21.34
L1	.083	.102	2.11	2.59
Q	.210	.244	5.33	6.20
R	.100	.180	2.54	4.57
S	.660	.690	16.76	17.53
T	.590	.620	14.99	15.75
U	.065	.080	1.65	2.03

