

Symbol	Test Conditions	Maximum Ratings	
$V_{CES}$	$T_J = 25^\circ C$ to $150^\circ C$	600	V
$V_{CGR}$	$T_J = 25^\circ C$ to $150^\circ C$ , $R_{GE} = 1M\Omega$	600	V
$V_{GES}$	Continuous	$\pm 20$	V
$V_{GEM}$	Transient	$\pm 30$	V
$I_{C25}$	$T_C = 25^\circ C$ ( Chip Capability )	200	A
$I_{C90}$	$T_C = 90^\circ C$	120	A
$I_{LRMS}$	Terminal Current Limit	76	A
$I_{CM}$	$T_C = 25^\circ C$ , 1ms	300	A
<b>SSOA</b> <b>(RBSOA)</b>	$V_{GE} = 15V$ , $T_{VJ} = 125^\circ C$ , $R_G = 2.4\Omega$ Clamped Inductive Load	$I_{CM} = 200$ @ $0.8 \cdot V_{CES}$	A V
$P_C$	$T_C = 25^\circ C$	660	W
$T_J$		-55 ... +150	$^\circ C$
$T_{JM}$		150	$^\circ C$
$T_{stg}$		-55 ... +150	$^\circ C$
$T_L$	Maximum Lead Temperature for Soldering	300	$^\circ C$
$T_{SOLD}$	1.6 mm (0.062 in.) from Case for 10	260	$^\circ C$
$M_d$	Mounting Torque ( IXGK )	1.13/10	Nm/lb.in.
$F_c$	Mounting Force ( IXGX )	20..120/4.5..27	N/lb.
<b>Weight</b>	TO-264	10	g
	PLUS247	6	g

TO-264 (IXGK)

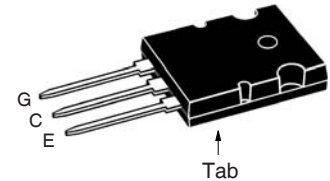

PLUS247 (IXGX)

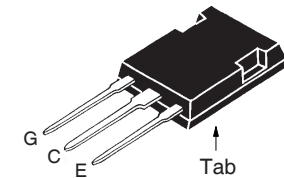

G = Gate                      E = Emitter  
C = Collector                Tab = Collector

### Features

- Very High Current, Fast Switching IGBT
- Low  $V_{CE(sat)}$ 
  - for Minimum On-State Conduction Losses
- MOS Gate turn-on
  - Drive Simplicity

### Advantages

- PLUS 247™ Package for Clip or Spring Mounting
- Space Savings
- High Power Density

### Applications

- AC Motor Speed Drives
- DC Servo and Robot Drives
- DC Choppers
- Uninterruptible Power Supplies (UPS)
- Switch-Mode and Resonant-Mode Power Supplies

Symbol	Test Conditions ( $T_J = 25^\circ C$ , Unless Otherwise Specified)	Characteristic Values		
		Min.	Typ.	Max.
$BV_{CES}$	$I_C = 1mA$ , $V_{GE} = 0V$	600		V
$V_{GE(th)}$	$I_C = 4mA$ , $V_{CE} = V_{GE}$	2.5		5.5 V
$I_{CES}$	$V_{CE} = V_{CES}$ , $V_{GE} = 0V$ $T_J = 125^\circ C$			200 $\mu A$ 2 mA
$I_{GES}$	$V_{CE} = 0V$ , $V_{GE} = \pm 20V$			$\pm 400$ nA
$V_{CE(sat)}$	$I_C = I_{C90}$ , $V_{GE} = 15V$ , Note 1			2.1 V

Symbol	Test Conditions ( $T_J = 25^\circ\text{C}$ , Unless Otherwise Specified)	Characteristic Values			
		Min.	Typ.	Max.	
$g_{fs}$	$I_C = 60\text{A}, V_{CE} = 10\text{V}$ , Note 1	50	75	S	
$C_{ies}$	$V_{CE} = 25\text{V}, V_{GE} = 0\text{V}, f = 1\text{MHz}$		11	nF	
$C_{oes}$			680	pF	
$C_{res}$			190	pF	
$Q_g$	$I_C = I_{C90}, V_{GE} = 15\text{V}, V_{CE} = 0.5 \cdot V_{CES}$		350	nC	
$Q_{ge}$			72	nC	
$Q_{gc}$			131	nC	
$t_{d(on)}$	<b>Inductive Load, <math>T_J = 25^\circ\text{C}</math></b> $I_C = 100\text{A}, V_{GE} = 15\text{V}$ $V_{CE} = 0.8 \cdot V_{CES}, R_G = 2.4\Omega$ Note 2		60	ns	
$t_{ri}$			45	ns	
$E_{on}$			2.4	mJ	
$t_{d(off)}$			200	360	ns
$t_{fi}$			160	280	ns
$E_{off}$			5.5	9.6	mJ
$t_{d(on)}$	<b>Inductive Load, <math>T_J = 125^\circ\text{C}</math></b> $I_C = 100\text{A}, V_{GE} = 15\text{V}$ $V_{CE} = 0.8 \cdot V_{CES}, R_G = 2.4\Omega$ Note 2		60	ns	
$t_{ri}$			60	ns	
$E_{on}$			4.8	mJ	
$t_{d(off)}$			290	ns	
$t_{fi}$			250	ns	
$E_{off}$			8.7	mJ	
$R_{thJC}$			0.19	$^\circ\text{C/W}$	
$R_{thCS}$		0.15		$^\circ\text{C/W}$	

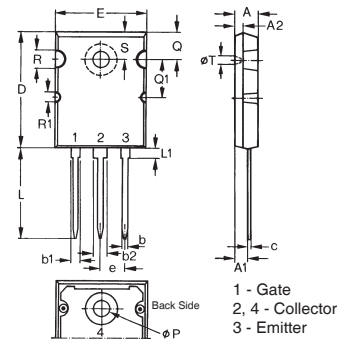
**TO-264 AA ( IXGK ) Outline**

Dim.	Millimeter		Inches	
	Min.	Max.	Min.	Max.
A	4.82	5.13	.190	.202
A1	2.54	2.89	.100	.114
A2	2.00	2.10	.079	.083
b	1.12	1.42	.044	.056
b1	2.39	2.69	.094	.106
b2	2.90	3.09	.114	.122
c	0.53	0.83	.021	.033
D	25.91	26.16	1.020	1.030
E	19.81	19.96	.780	.786
e	5.46 BSC		.215 BSC	
J	0.00	0.25	.000	.010
K	0.00	0.25	.000	.010
L	20.32	20.83	.800	.820
L1	2.29	2.59	.090	.102
P	3.17	3.66	.125	.144
Q	6.07	6.27	.239	.247
Q1	8.38	8.69	.330	.342
R	3.81	4.32	.150	.170
R1	1.78	2.29	.070	.090
S	6.04	6.30	.238	.248
T	1.57	1.83	.062	.072

**Notes:**

1. Pulse test,  $t \leq 300\mu\text{s}$ , duty cycle,  $d \leq 2\%$ .
2. Switching times & energy losses may increase for higher  $V_{CE}(\text{Clamp})$ ,  $T_J$  or  $R_G$ .

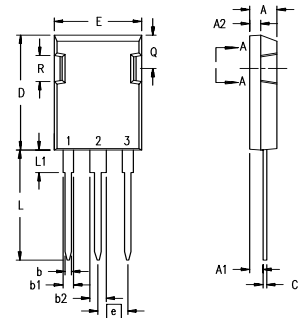
**PLUS247™ ( IXGX ) Outline**

Terminals: 1 - Gate  
2 - Collector  
3 - Emitter

Dim.	Millimeter		Inches	
	Min.	Max.	Min.	Max.
A	4.83	5.21	.190	.205
A <sub>1</sub>	2.29	2.54	.090	.100
A <sub>2</sub>	1.91	2.16	.075	.085
b	1.14	1.40	.045	.055
b <sub>1</sub>	1.91	2.13	.075	.084
b <sub>2</sub>	2.92	3.12	.115	.123
C	0.61	0.80	.024	.031
D	20.80	21.34	.819	.840
E	15.75	16.13	.620	.635
e	5.45 BSC		.215 BSC	
L	19.81	20.32	.780	.800
L1	3.81	4.32	.150	.170
Q	5.59	6.20	.220	0.244
R	4.32	4.83	.170	.190

IXYS Reserves the Right to Change Limits, Test Conditions, and Dimensions.

**Fig. 1. Output Characteristics**  
**@ 25 °C**

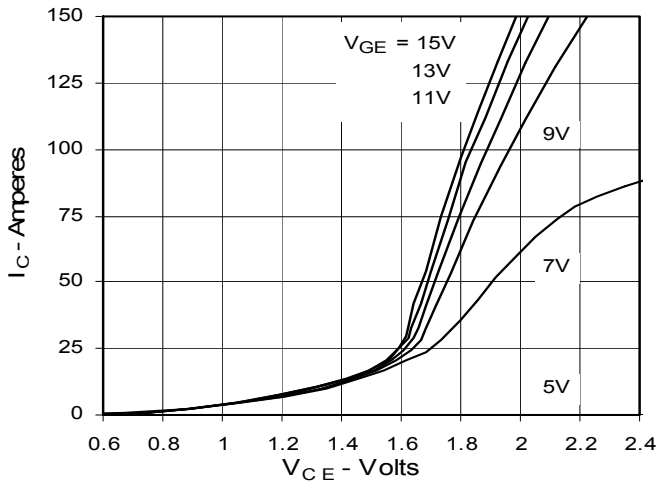

**Fig. 2. Extended Output Characteristics**  
**@ 25 °C**

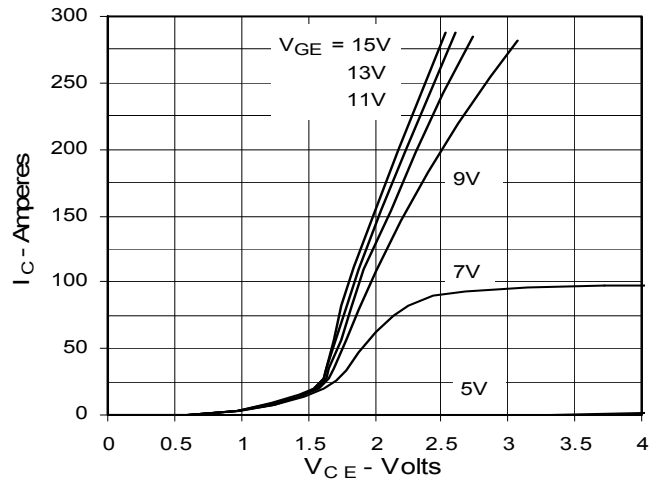

**Fig. 3. Output Characteristics**  
**@ 125 °C**

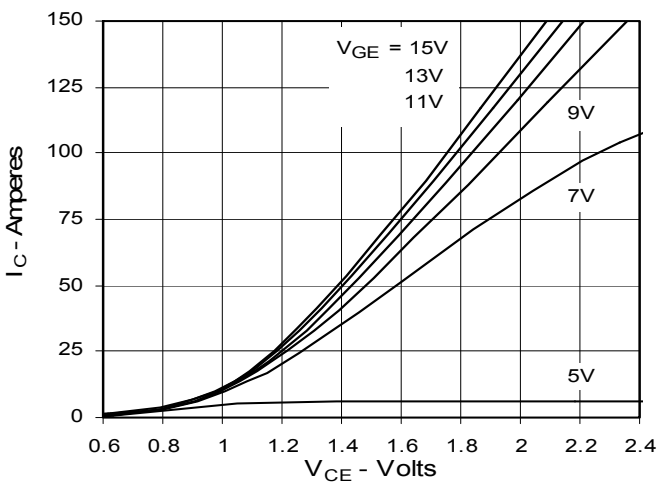

**Fig. 4. Dependence of  $V_{CE(sat)}$  on Temperature**

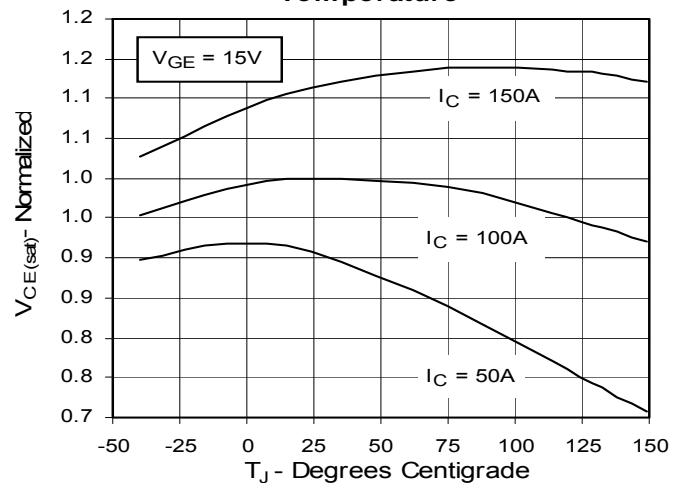

**Fig. 5. Collector-to-Emitter Voltage vs. Gate-to-Emitter voltage**

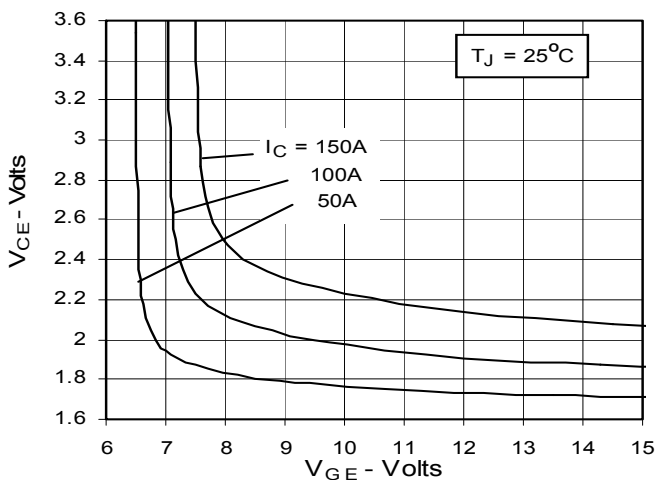

**Fig. 6. Input Admittance**

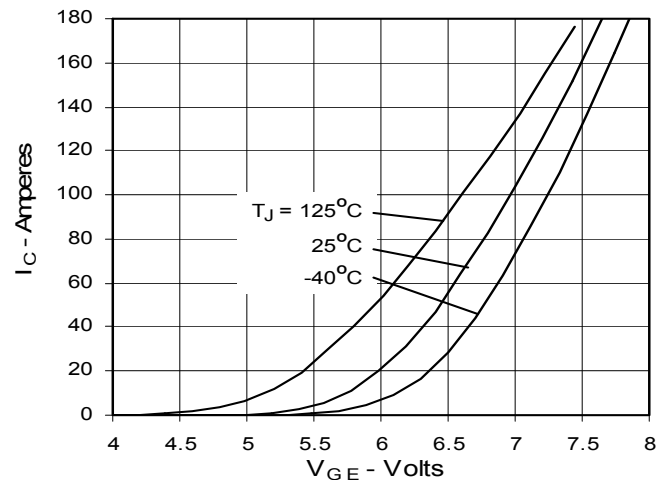

**Fig. 7. Transconductance**

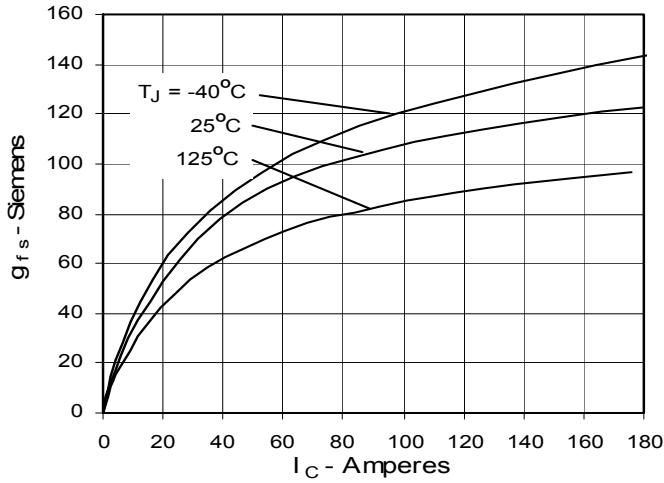

**Fig. 8. Dependence of Turn-off Energy Loss on  $R_G$**

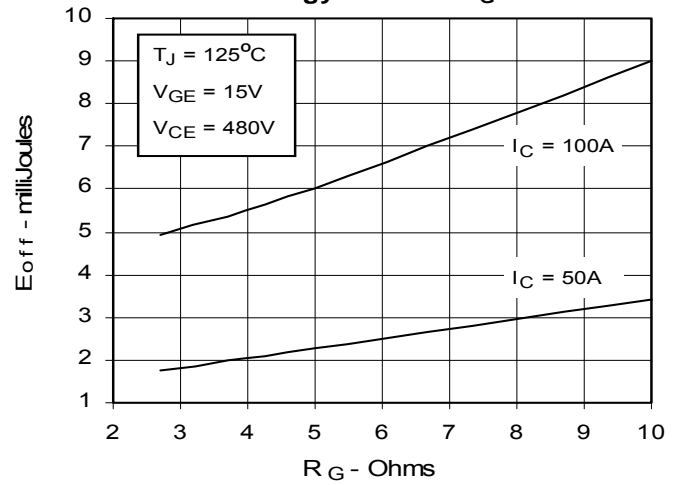

**Fig. 9. Dependence of Turn-Off Energy Loss on  $I_C$**

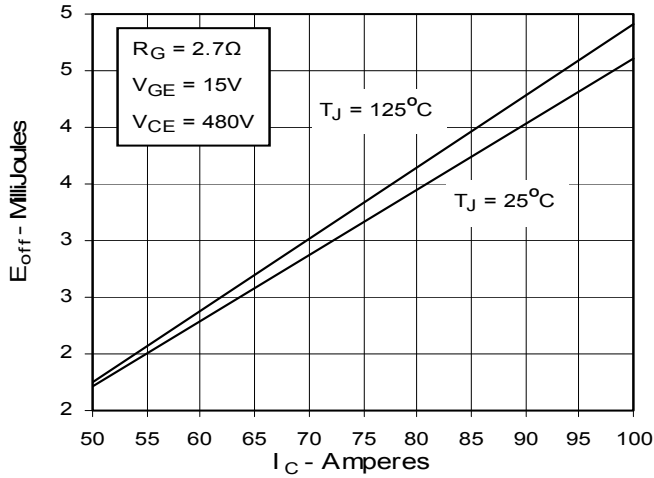

**Fig. 10. Dependence of Turn-off Energy Loss on Temperature**

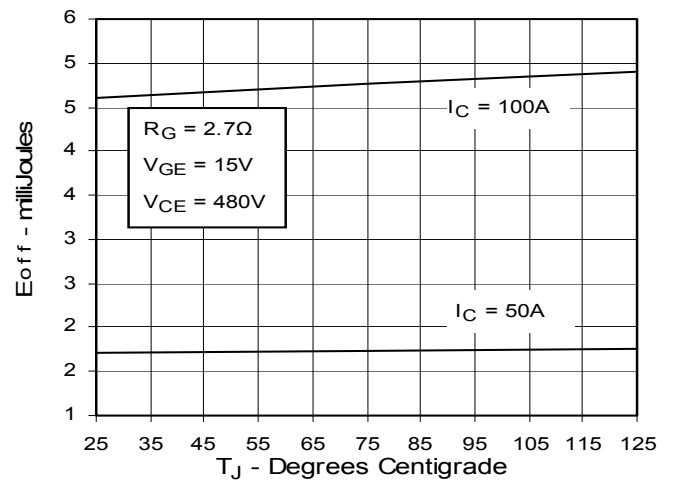

**Fig. 11. Dependence of Turn-off Switching Time on  $R_G$**

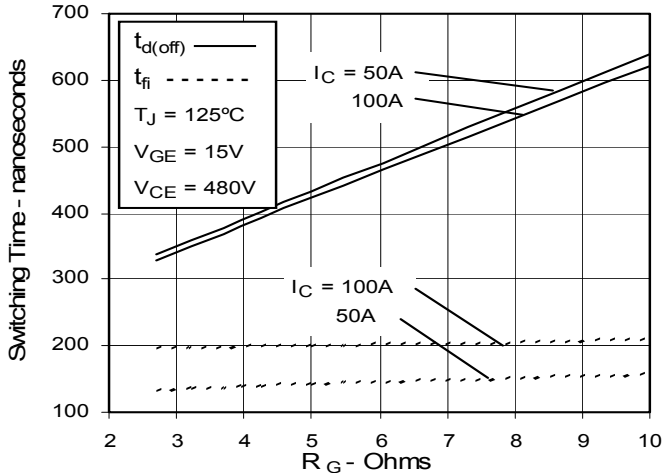

**Fig. 12. Dependence of Turn-off Switching Time on  $I_C$**

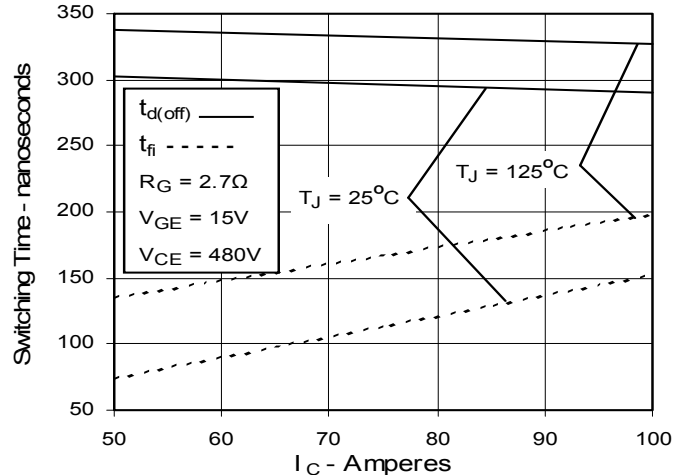

**Fig. 13. Dependence of Turn-off Switching Time on Temperature**

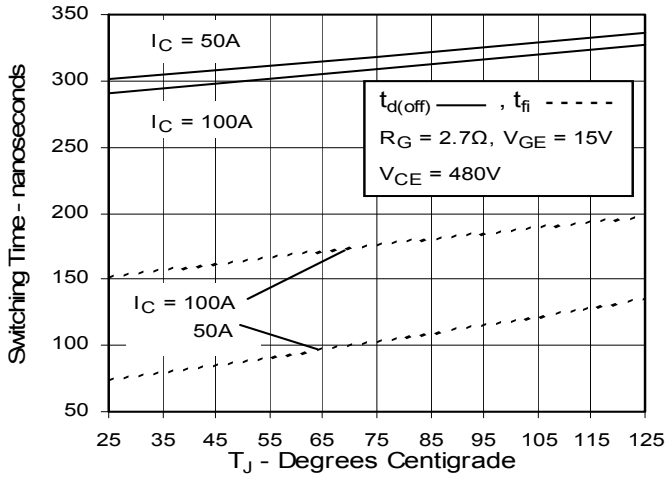

**Fig. 14. Gate Charge**

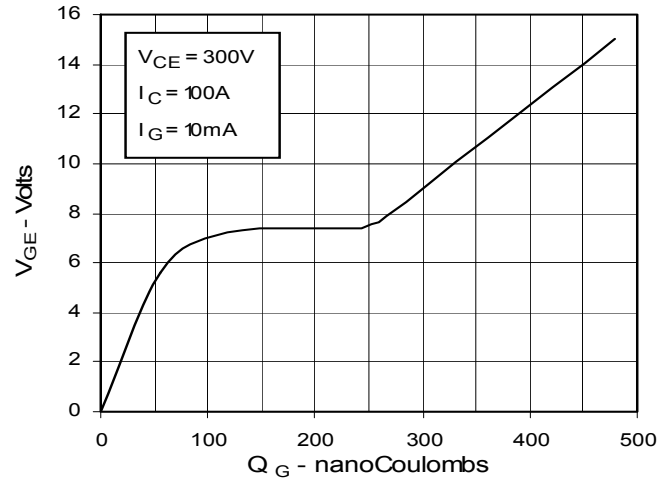

**Fig. 15. Capacitance**

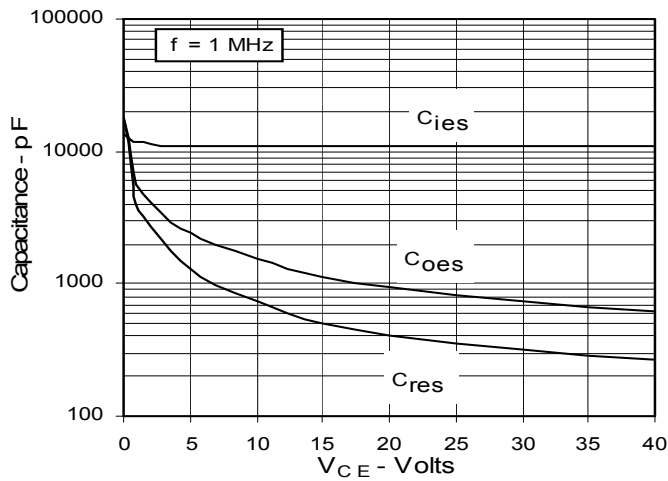

**Fig. 16. Reverse-Bias Safe Operating Area**

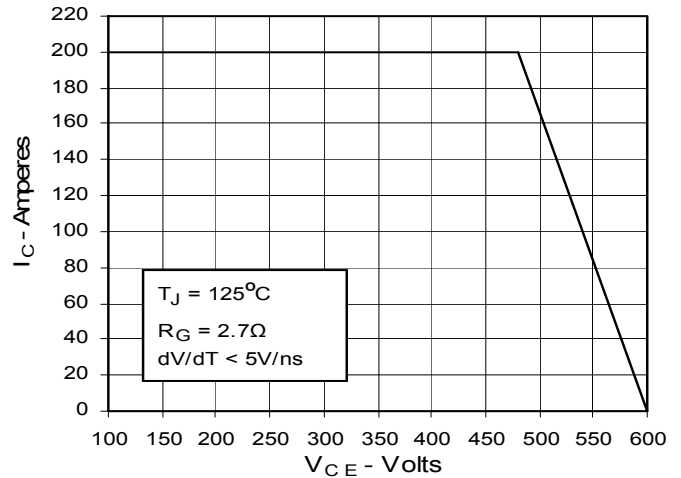

**Fig. 17. Maximum Transient Thermal Resistance**

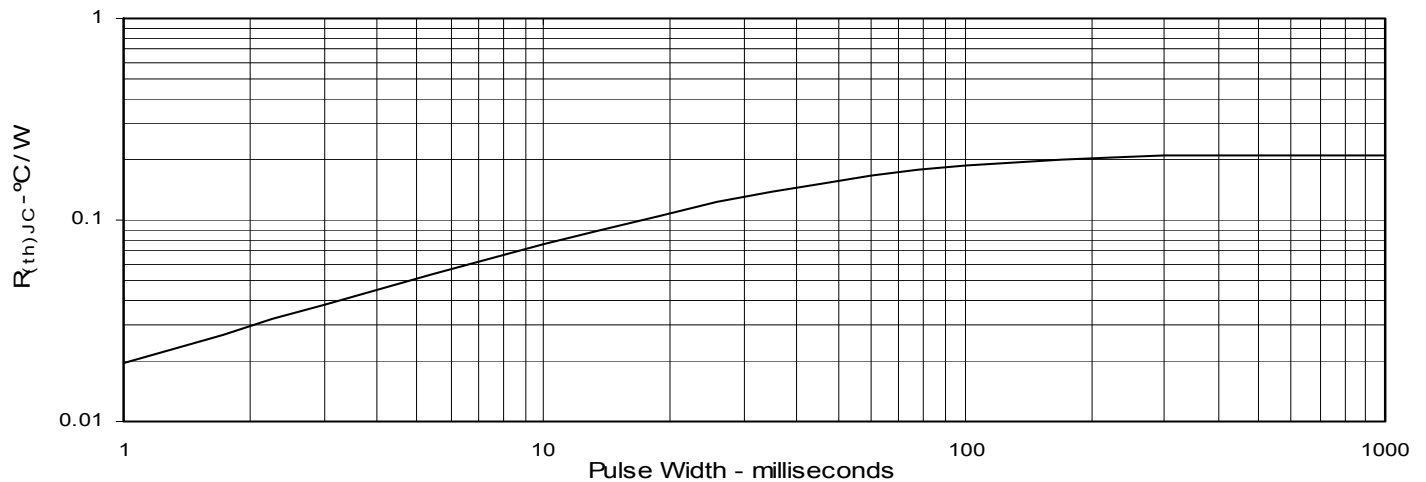



---

Disclaimer Notice - Information furnished is believed to be accurate and reliable. However, users should independently evaluate the suitability of and test each product selected for their own applications. Littelfuse products are not designed for, and may not be used in, all applications. Read complete Disclaimer Notice at [www.littelfuse.com/disclaimer-electronics](http://www.littelfuse.com/disclaimer-electronics).