

# HiPerFAST™ IGBT with Fast Diode

IXGH 50N90B2D1  
IXGK 50N90B2D1  
IXGX 50N90B2D1

$V_{CES}$  = 900 V  
 $I_{C25}$  = 75 A  
 $V_{CE(sat)}$  = 2.7 V  
 $t_{fi typ}$  = 200 ns

## B2-Class High Speed IGBT with Fast Diode

Preliminary Data Sheet

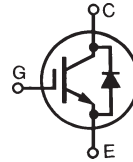

Symbol	Test Conditions	Maximum Ratings	
$V_{CES}$	$T_J = 25^\circ\text{C}$ to $150^\circ\text{C}$	900	V
$V_{CGR}$	$T_J = 25^\circ\text{C}$ to $150^\circ\text{C}$ ; $R_{GE} = 1\text{ M}\Omega$	900	V
$V_{GES}$	Continuous	$\pm 20$	V
$V_{GEM}$	Transient	$\pm 30$	V
$I_{C25}$	$T_C = 25^\circ\text{C}$ (limited by leads)	75	A
$I_{C110}$	$T_C = 110^\circ\text{C}$	50	A
$I_{CM}$	$T_C = 25^\circ\text{C}$ , 1 ms	200	A
<b>SSOA</b> <b>(RBSOA)</b>	$V_{GE} = 15\text{ V}$ , $T_{VJ} = 125^\circ\text{C}$ , $R_G = 10\ \Omega$ Clamped inductive load @ $\leq 600\text{V}$	$I_{CM} = 100$	A
$P_C$	$T_C = 25^\circ\text{C}$	400	W
$T_J$		-55 ... +150	$^\circ\text{C}$
$T_{JM}$		150	$^\circ\text{C}$
$T_{stg}$		-55 ... +150	$^\circ\text{C}$
Maximum lead temperature for soldering 1.6 mm (0.062 in.) from case for 10 s		300	$^\circ\text{C}$
$M_d$	Mounting torque (TO-247, TO-264)	1.13/10Nm/lb.in.	
$F_C$	Mounting force (PLUS247)	20..120 / 4.5..25	N/lb
<b>Weight</b>		TO-247	6 g
		TO-264	10 g
		PLUS247	6 g

TO-247 (IXGH)

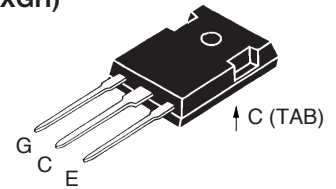

PLUS247 (IXGX)

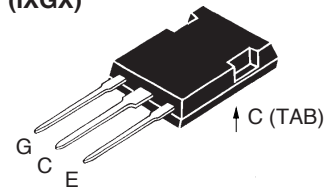

TO-264 (IXGK)

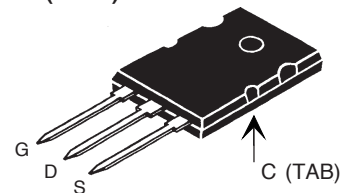

G = Gate      C = Collector  
E = Emitter    TAB = Collector

### Features

- High frequency IGBT
- High current handling capability
- MOS Gate turn-on  
- drive simplicity

### Applications

- PFC circuits
- Uninterruptible power supplies (UPS)
- Switched-mode and resonant-mode power supplies
- AC motor speed control
- DC servo and robot drives
- DC choppers

### Advantages

- High power density
- Very fast switching speeds for high frequency applications

Symbol	Test Conditions ( $T_J = 25^\circ\text{C}$ unless otherwise specified)	Characteristic Values		
		min.	typ.	max.
$V_{GE(th)}$	$I_C = 250\ \mu\text{A}$ , $V_{CE} = V_{GE}$	3.0		5.0 V
$I_{CES}$	$V_{CE} = V_{CES}$ $V_{GE} = 0\text{ V}$ $T_J = 150^\circ\text{C}$			50 $\mu\text{A}$ 1 mA
$I_{GES}$	$V_{CE} = 0\text{ V}$ , $V_{GE} = \pm 20\text{ V}$			$\pm 100\text{ nA}$
$V_{CE(sat)}$	$I_C = I_{C110}$ , $V_{GE} = 15\text{ V}$ , Note 1 $T_J = 125^\circ\text{C}$	2.2	2.7	V V

Symbol	Test Conditions ( $T_J = 25^\circ\text{C}$ unless otherwise specified)	Characteristic Values		
		min.	typ.	max.
$g_{fs}$	$I_C = I_{C110}; V_{CE} = 10\text{ V}$ , Note 1	25	40	S
$C_{ies}$	$V_{CE} = 25\text{ V}$ , $V_{GE} = 0\text{ V}$ , $f = 1\text{ MHz}$		2500	pF
$C_{oes}$			205	pF
$C_{res}$			75	pF
$Q_g$	$I_C = I_{C110}$ , $V_{GE} = 15\text{ V}$ , $V_{CE} = 0.5 V_{CES}$		135	nC
$Q_{ge}$			23	nC
$Q_{gc}$			50	nC
$t_{d(on)}$	<b>Inductive load</b> $I_C = I_{C110}$ , $V_{GE} = 15\text{ V}$ $V_{CE} = 720\text{ V}$ , $R_G = R_{off} = 5\ \Omega$		20	ns
$t_{ri}$			28	ns
$t_{d(off)}$			350	500 ns
$t_{fi}$			200	ns
$E_{off}$			4.7	7.5 mJ
$t_{d(on)}$		<b>Inductive load, <math>T_J = 125^\circ\text{C}</math></b> $I_C = I_{C110}$ , $V_{GE} = 15\text{ V}$ $V_{CE} = 720\text{ V}$ , $R_G = R_{off} = 5\ \Omega$		20
$t_{ri}$			28	ns
$E_{on}$			1.5	mJ
$t_{d(off)}$			400	ns
$t_{fi}$			420	ns
$E_{off}$			8.7	mJ
$R_{thJC}$			0.31	K/W
$R_{thCH}$		0.21		K/W

<b>Diode</b>
--------------

Symbol	Conditions	Maximum Ratings	
$I_{F25}$	$T_C = 115^\circ\text{C}$	30	A

Symbol	Conditions ( $T_J = 25^\circ\text{C}$ unless otherwise specified)	Characteristic Values		
		min.	typ.	max.
$V_F$	$I_F = 30\text{ A}$ ; Note 1 $T_{VJ} = 150^\circ\text{C}$		2.5	2.75 V
			1.8	V
$I_{RM}$	$I_F = 10\text{ A}$ ; $di_F/dt = -100\text{ A}/\mu\text{s}$ ; $T_{VJ} = 100^\circ\text{C}$ $V_R = 100\text{ V}$ ; $V_{GE} = 0\text{ V}$		5.5	11.5 A
$t_{rr}$			200	ns
$R_{thJC}$	with heat transfer paste		0.25	0.9 K/W
$R_{thCH}$				K/W

Note 1: Pulse test,  $t \leq 300\ \mu\text{s}$ , duty cycle  $\leq 2\%$

IXYS reserves the right to change limits, test conditions, and dimensions.

IXYS MOSFETs and IGBTs are covered by one or more of the following U.S. patents:	4,835,592	4,931,844	5,049,961	5,237,481	6,162,665	6,404,065 B1	6,683,344	6,727,585
	4,850,072	5,017,508	5,063,307	5,381,025	6,259,123 B1	6,534,343	6,710,405 B2	6,759,692
	4,881,106	5,034,796	5,187,117	5,486,715	6,306,728 B1	6,583,505	6,710,463	6,771,478 B2

**Fig. 1. Output Characteristics**  
@ 25 °C

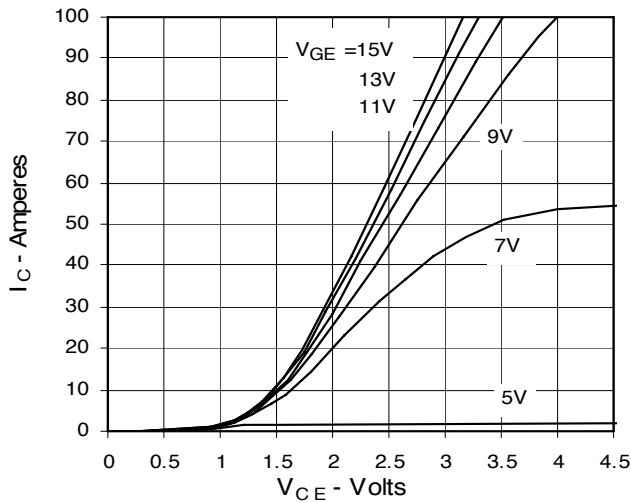

**Fig. 2. Extended Output Characteristics**  
@ 25 °C

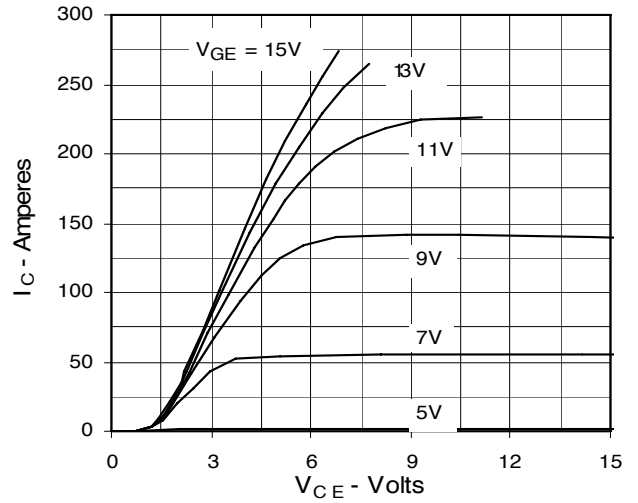

**Fig. 3. Output Characteristics**  
@ 125 °C

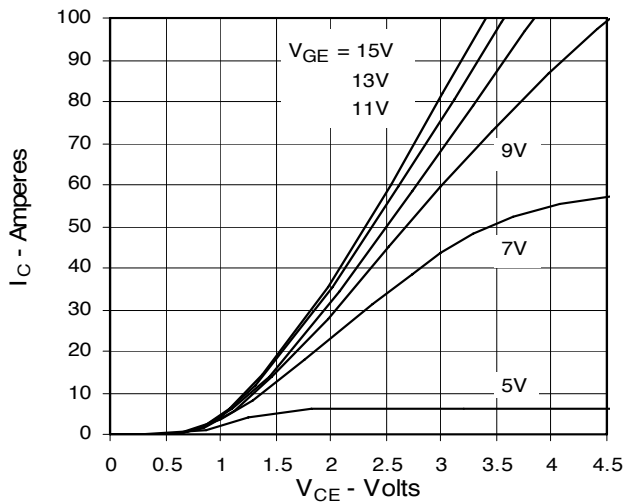

**Fig. 4. Dependence of  $V_{CE(sat)}$  on Temperature**

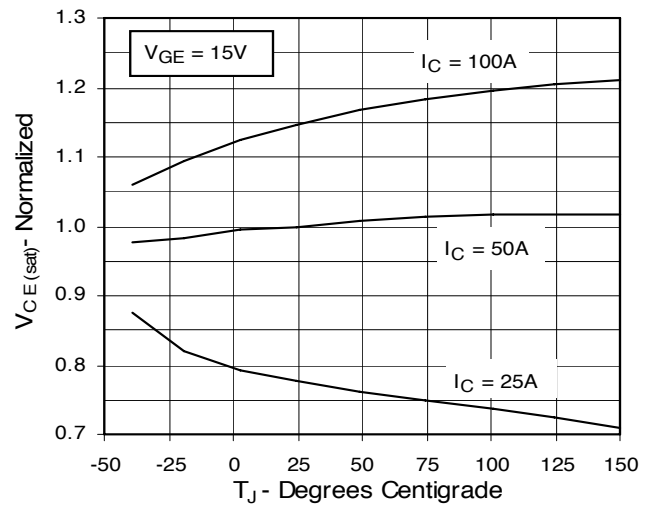

**Fig. 5. Collector-to-Emitter Voltage vs. Gate-to-Emitter voltage**

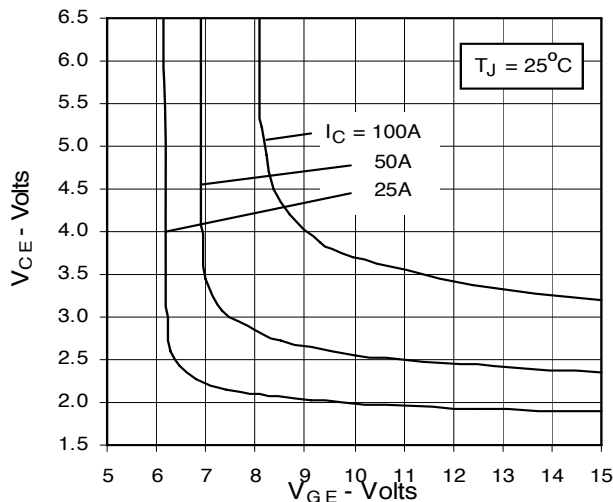

**Fig. 6. Input Admittance**

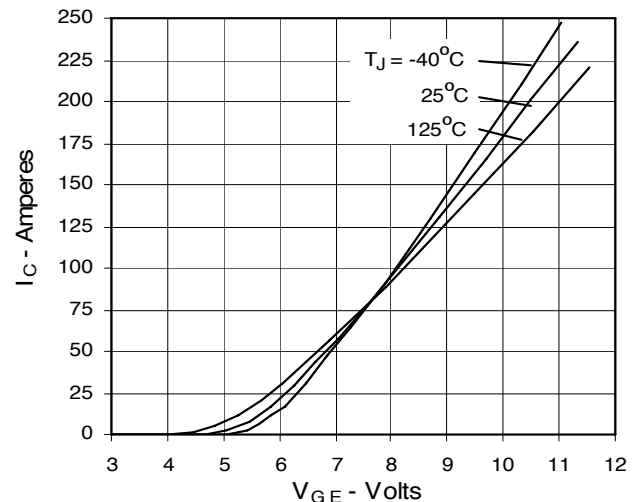

**Fig. 7. Transconductance**

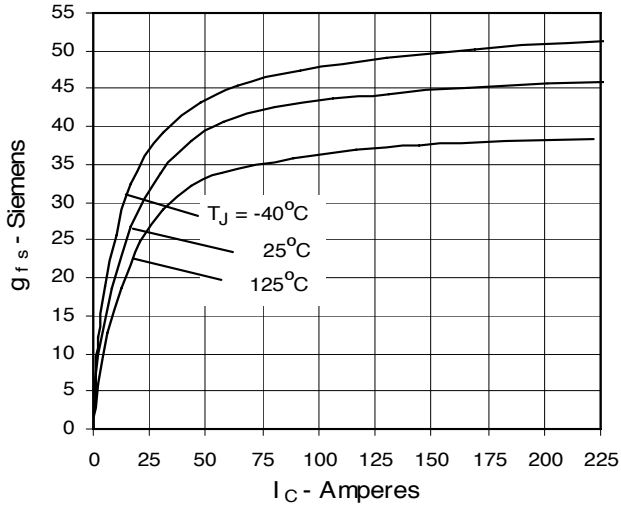

**Fig. 8. Dependence of Turn-off Energy Loss on  $R_G$**

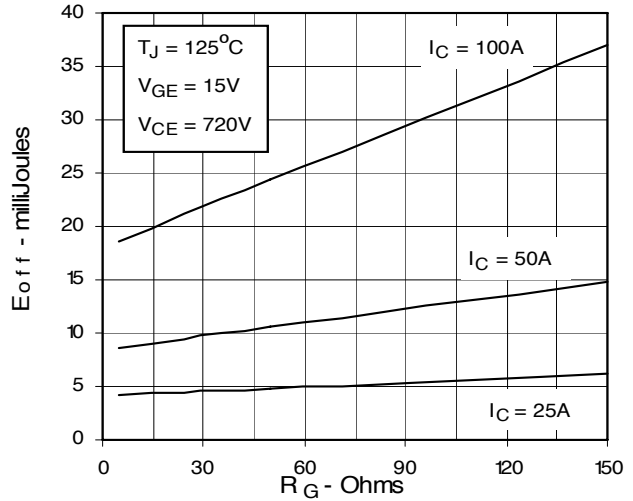

**Fig. 9. Dependence of Turn-Off Energy Loss on  $I_C$**

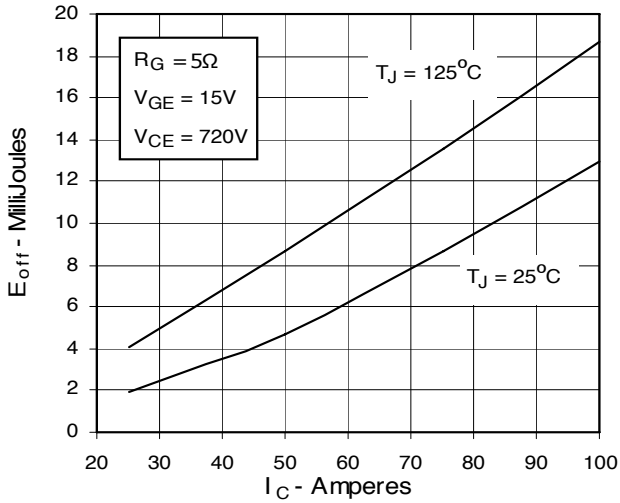

**Fig. 10. Dependence of Turn-off Energy Loss on Temperature**

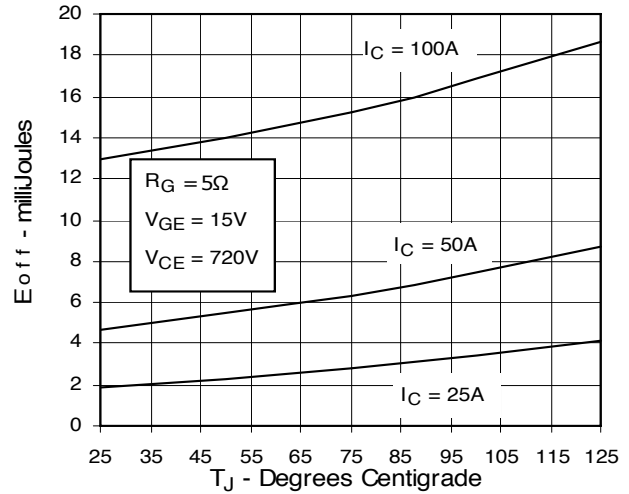

**Fig. 11. Dependence of Turn-off Switching Time on  $R_G$**

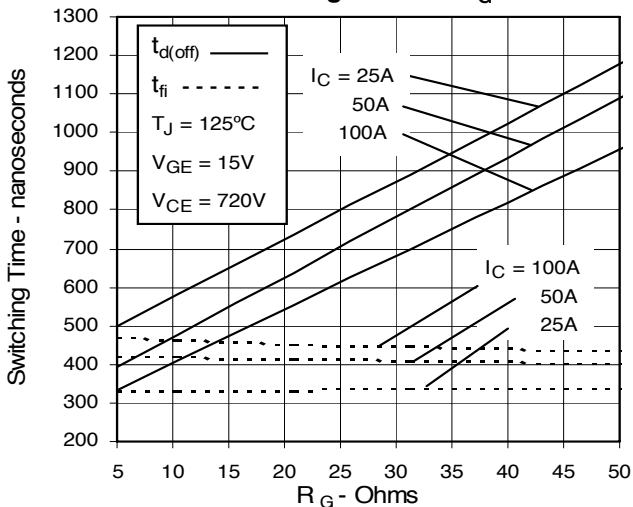

**Fig. 12. Dependence of Turn-off Switching Time on  $I_C$**

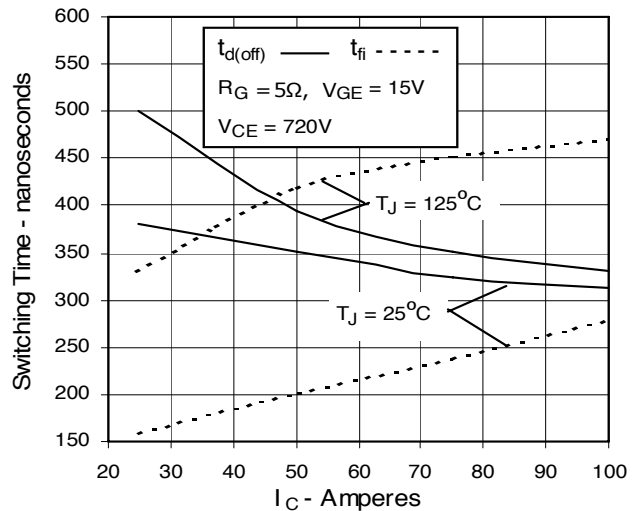

**Fig. 13. Dependence of Turn-off Switching Time on Temperature**

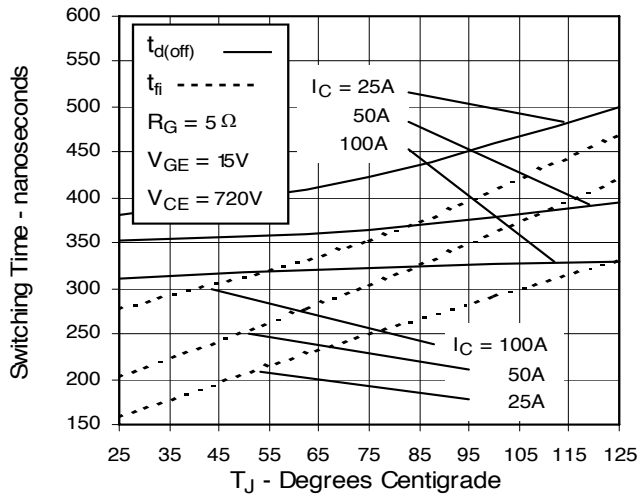

**Fig. 14. Gate Charge**

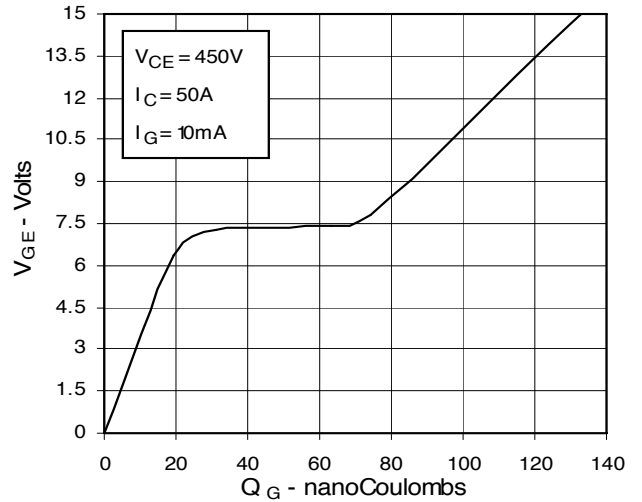

**Fig. 15. Capacitance**

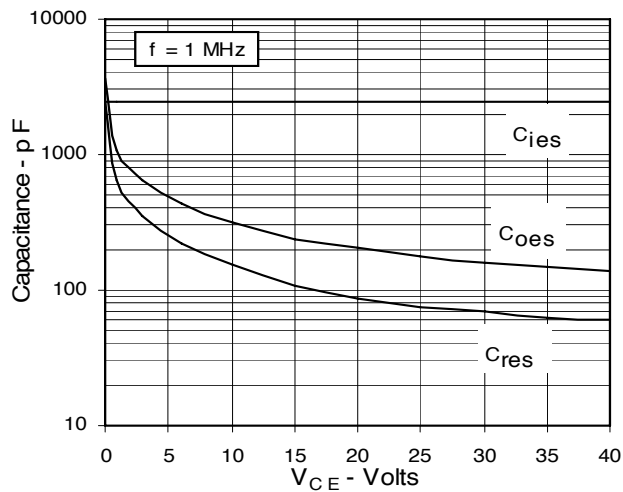

**Fig. 16. Reverse-Bias Safe Operating Area**

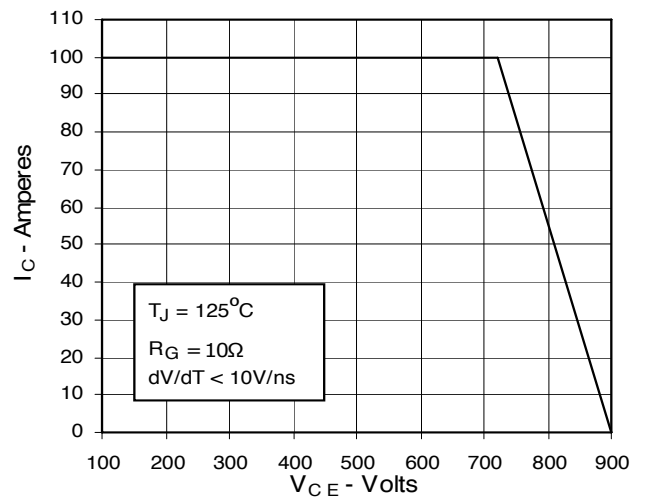

**Fig. 17. Maximum Transient Thermal Resistance**

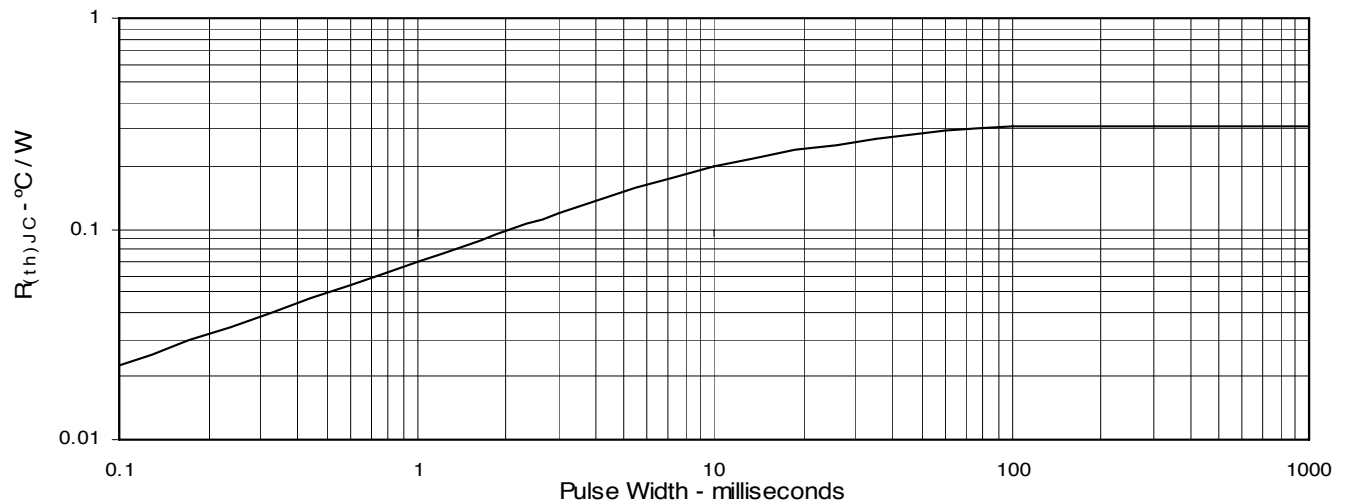

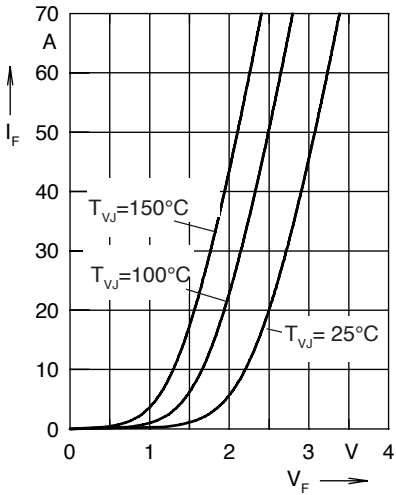

Fig. 18. Forward current  $I_F$  versus  $V_F$

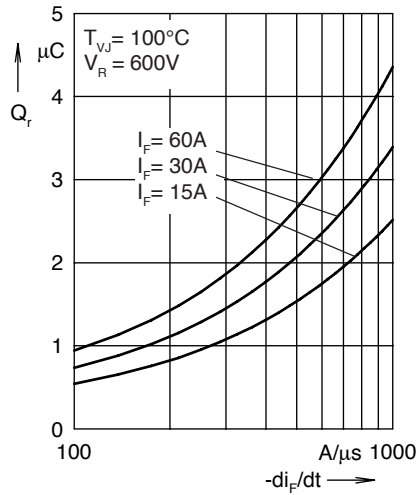

Fig. 19. Reverse recovery charge  $Q_r$  versus  $-di_F/dt$

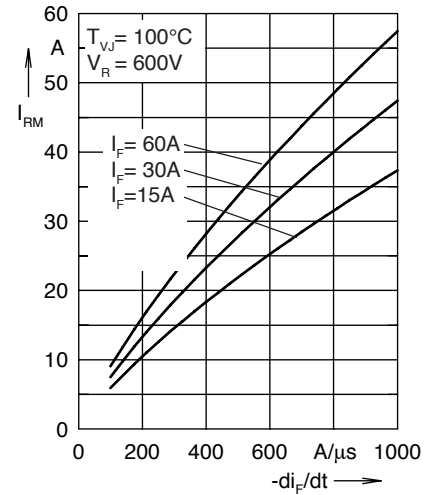

Fig. 20. Peak reverse current  $I_{RM}$  versus  $-di_F/dt$

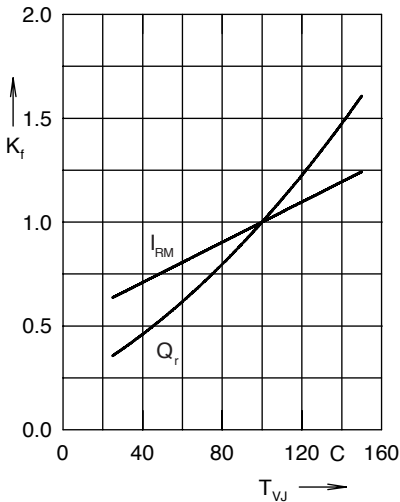

Fig. 21. Dynamic parameters  $Q_r$ ,  $I_{RM}$  versus  $T_{VJ}$

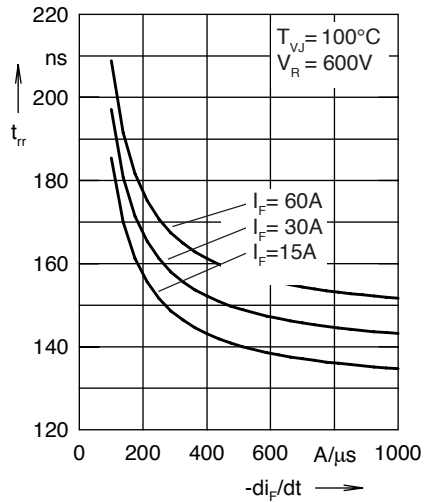

Fig. 22. Recovery time  $t_{rr}$  versus  $-di_F/dt$

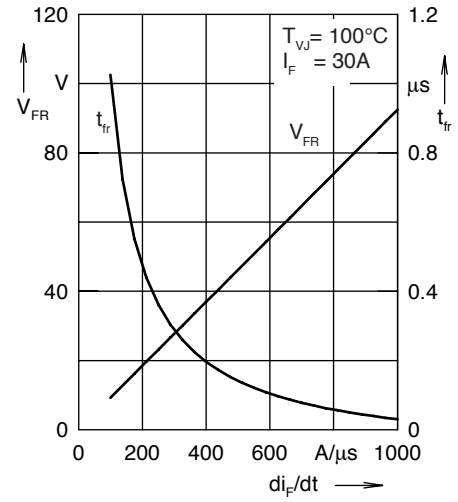

Fig. 23. Peak forward voltage  $V_{FR}$  and  $t_{fr}$  versus  $di_F/dt$

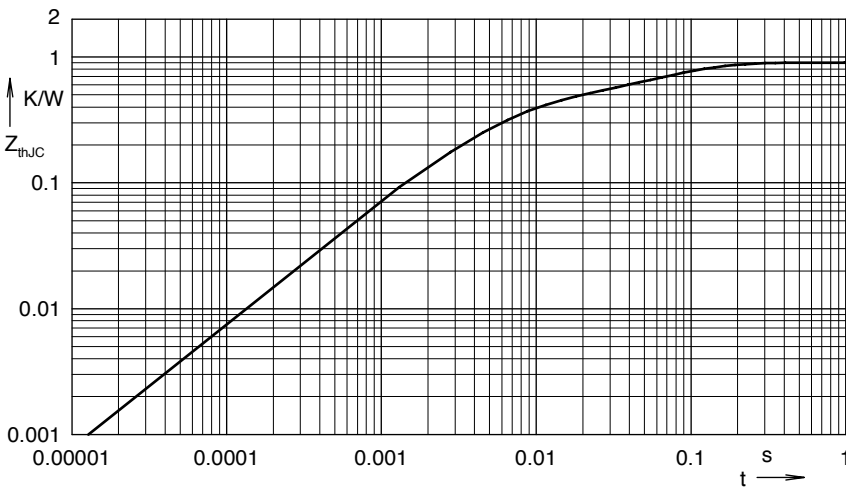

Fig. 24. Transient thermal resistance junction to case

Constants for  $Z_{thJC}$  calculation:

i	$R_{thi}$ (K/W)	$t_i$ (s)
1	0.465	0.0052
2	0.179	0.0003
3	0.256	0.0397

## Package Outlines

### TO-247 AD Outline

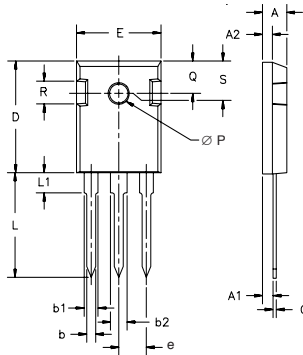

Dim.	Millimeter		Inches	
	Min.	Max.	Min.	Max.
A	4.7	5.3	.185	.209
A <sub>1</sub>	2.2	2.54	.087	.102
A <sub>2</sub>	2.2	2.6	.059	.098
b	1.0	1.4	.040	.055
b <sub>1</sub>	1.65	2.13	.065	.084
b <sub>2</sub>	2.87	3.12	.113	.123
C	.4	.8	.016	.031
D	20.80	21.46	.819	.845
E	15.75	16.26	.610	.640
e	5.20	5.72	0.205	0.225
L	19.81	20.32	.780	.800
L1		4.50		.177
∅P	3.55	3.65	.140	.144
Q	5.89	6.40	0.232	0.252
R	4.32	5.49	.170	.216
S	6.15	BSC	.242	BSC

### PLUS 247™ Outline

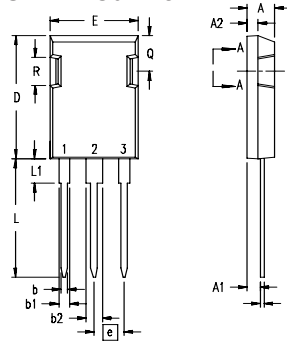

Dim.	Millimeter		Inches	
	Min.	Max.	Min.	Max.
A	4.83	5.21	.190	.205
A <sub>1</sub>	2.29	2.54	.090	.100
A <sub>2</sub>	1.91	2.16	.075	.085
b	1.14	1.40	.045	.055
b <sub>1</sub>	1.91	2.13	.075	.084
b <sub>2</sub>	2.92	3.12	.115	.123
C	0.61	0.80	.024	.031
D	20.80	21.34	.819	.840
E	15.75	16.13	.620	.635
e	5.45	BSC	.215	BSC
L	19.81	20.32	.780	.800
L1	3.81	4.32	.150	.170
Q	5.59	6.20	.220	0.244
R	4.32	4.83	.170	.190

### TO-264 AA Outline

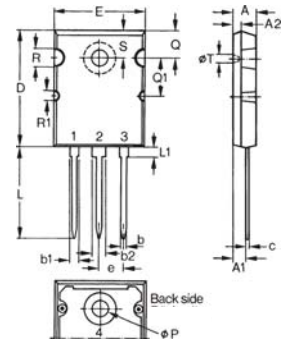

Dim.	Millimeter		Inches	
	Min.	Max.	Min.	Max.
A	4.82	5.13	.190	.202
A <sub>1</sub>	2.54	2.89	.100	.114
A <sub>2</sub>	2.00	2.10	.079	.083
b	1.12	1.42	.044	.056
b <sub>1</sub>	2.39	2.69	.094	.106
b <sub>2</sub>	2.90	3.09	.114	.122
c	0.53	0.83	.021	.033
D	25.91	26.16	1.020	1.030
E	19.81	19.96	.780	.786
e	5.46	BSC	.215	BSC
J	0.00	0.25	.000	.010
K	0.00	0.25	.000	.010
L	20.32	20.83	.800	.820
L1	2.29	2.59	.090	.102
P	3.17	3.66	.125	.144
Q	6.07	6.27	.239	.247
Q1	8.38	8.69	.330	.342
R	3.81	4.32	.150	.170
R1	1.78	2.29	.070	.090
S	6.04	6.30	.238	.248
T	1.57	1.83	.062	.072

Terminals: 1 - Gate  
 2 - Drain (Collector)  
 3 - Source (Emitter)  
 4 - Drain (Collector)

### PRELIMINARY TECHNICAL INFORMATION

The product presented herein is under development. The Technical Specifications offered are derived from data gathered during objective characterizations of preliminary engineering lots; but also may yet contain some information supplied during a subjective pre-production design evaluation. IXYS reserves the right to change limits, test conditions, and dimensions without notice.



---

Disclaimer Notice - Information furnished is believed to be accurate and reliable. However, users should independently evaluate the suitability of and test each product selected for their own applications. Littelfuse products are not designed for, and may not be used in, all applications. Read complete Disclaimer Notice at [www.littelfuse.com/disclaimer-electronics](http://www.littelfuse.com/disclaimer-electronics).