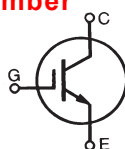


**GenX3™ 600V IGBT**
**IXGH64N60B3\***  
**IXGT64N60B3**

\*Obsolete Part Number

 Medium speed low V<sub>sat</sub> PT  
 IGBTs for 5 - 40kHz switching


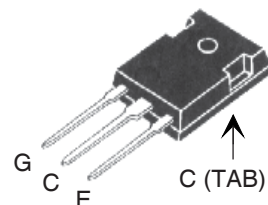
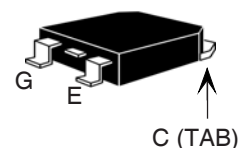
$$V_{CES} = 600V$$

$$I_{C110} = 64A$$

$$V_{CE(sat)} \leq 1.8V$$

$$t_{fi(typ)} = 88ns$$

Symbol	Test Conditions	Maximum Ratings	
$V_{CES}$	$T_C = 25^\circ C$ to $150^\circ C$	600	V
$V_{CGR}$	$T_J = 25^\circ C$ to $150^\circ C$ , $R_{GE} = 1M\Omega$	600	V
$V_{GES}$	Continuous	$\pm 20$	V
$V_{GEM}$	Transient	$\pm 30$	V
$I_{C110}$	$T_C = 110^\circ C$	64	A
$I_{CM}$	$T_C = 25^\circ C$ , 1ms	400	A
<b>SSOA</b> <b>(RBSOA)</b>	$V_{GE} = 15V$ , $T_{VJ} = 125^\circ C$ , $R_G = 3\Omega$ Clamped inductive load @ $\leq 600V$	$I_{CM} = 200$	A
$P_C$	$T_C = 25^\circ C$	460	W
$T_J$		-55 ... +150	$^\circ C$
$T_{JM}$		150	$^\circ C$
$T_{stg}$		-55 ... +150	$^\circ C$
$T_L$	1.6mm (0.062 in.) from case for 10s	300	$^\circ C$
$T_{SOLD}$	Plastic body for 10 seconds	260	$^\circ C$
$M_d$	Mounting torque (TO-247)	1.13/10	Nm/lb.in.
<b>Weight</b>	TO-247	6	g
	TO-268	5	g

**TO-247 (IXGH)**

**TO-268 (IXGT)**

 G = Gate    C = Collector  
 E = Emitter    TAB = Collector

**Features**

- Optimized for low conduction and switching losses
- Square RBSOA
- International standard packages

**Advantages**

- High power density
- Low gate drive requirement

**Applications**

- Power Inverters
- UPS
- Motor Drives
- SMPS
- PFC Circuits
- Battery Chargers
- Welding Machines
- Lamp Ballasts

Symbol	Test Conditions ( $T_J = 25^\circ C$ unless otherwise specified)	Characteristic Values		
		Min.	Typ.	Max.
$BV_{CES}$	$I_C = 250\mu A$ , $V_{GE} = 0V$	600		V
$V_{GE(th)}$	$I_C = 250\mu A$ , $V_{CE} = V_{GE}$	3.0		V
$I_{CES}$	$V_{CE} = V_{CES}$			50 $\mu A$
	$V_{GE} = 0V$		$T_J = 125^\circ C$	500 $\mu A$
$I_{GES}$	$V_{CE} = 0V$ , $V_{GE} = \pm 20V$			$\pm 100$ nA
$V_{CE(sat)}$	$I_C = 50A$ , $V_{GE} = 15V$ , Note 1	1.59	1.80	V

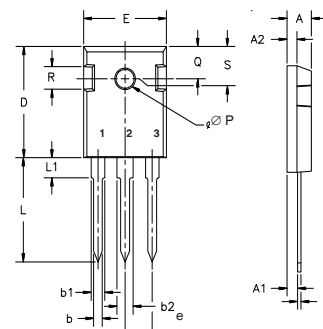
Symbol	Test Conditions	Characteristic Values		
		Min.	Typ.	Max.
$g_{fs}$	$I_C = 50A, V_{CE} = 10V, \text{Note 1}$	38	64	S
$C_{ies}$	$V_{CE} = 25V, V_{GE} = 0V, f = 1MHz$		4750	pF
$C_{oes}$			260	pF
$C_{res}$			65	pF
$Q_g$	$I_C = 50A, V_{GE} = 15V, V_{CE} = 0.5 \cdot V_{CES}$		168	nC
$Q_{ge}$			28	nC
$Q_{gc}$			61	nC
$t_{d(on)}$	<b>Inductive load, <math>T_J = 25^\circ C</math></b> $I_C = 50A, V_{GE} = 15V$ $V_{CE} = 480V, R_G = 3\Omega$		25	ns
$t_{ri}$			41	ns
$E_{on}$			1.5	mJ
$t_{d(off)}$			138	ns
$t_{fi}$			88	150 ns
$E_{off}$			1.0	1.9 mJ
$t_{d(on)}$	<b>Inductive load, <math>T_J = 125^\circ C</math></b> $I_C = 50A, V_{GE} = 15V$ $V_{CE} = 480V, R_G = 3\Omega$		24	ns
$t_{ri}$			40	ns
$E_{on}$			2.70	mJ
$t_{d(off)}$			195	ns
$t_{fi}$			131	ns
$E_{off}$			1.95	mJ
$R_{thJC}$			0.27	$^\circ C/W$
$R_{thCS}$			0.15	$^\circ C/W$

Note 1: Pulse test,  $t \leq 300\mu s$ , duty cycle,  $d \leq 2\%$ .

### PRELIMINARY TECHNICAL INFORMATION

The product presented herein is under development. The Technical Specifications offered are derived from data gathered during objective characterizations of preliminary engineering lots; but also may yet contain some information supplied during a pre-production design evaluation. IXYS reserves the right to change limits, test conditions, and dimensions without notice.

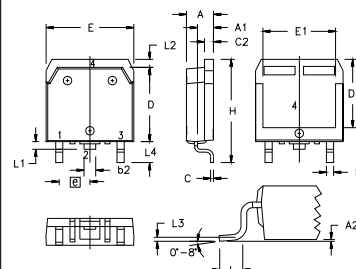
### TO-247 (IXGH) Outline



Terminals: 1 - Gate  
2 - Drain  
3 - Source  
Tab - Drain

Dim.	Millimeter		Inches	
	Min.	Max.	Min.	Max.
A	4.7	5.3	.185	.209
A <sub>1</sub>	2.2	2.54	.087	.102
A <sub>2</sub>	2.2	2.6	.059	.098
b	1.0	1.4	.040	.055
b <sub>1</sub>	1.65	2.13	.065	.084
b <sub>2</sub>	2.87	3.12	.113	.123
C	.4	.8	.016	.031
D	20.80	21.46	.819	.845
E	15.75	16.26	.610	.640
e	5.20	5.72	0.205	0.225
L	19.81	20.32	.780	.800
L <sub>1</sub>		4.50		.177
∅P	3.55	3.65	.140	.144
Q	5.89	6.40	0.232	0.252
R	4.32	5.49	.170	.216
S	6.15	BSC	242	BSC

### TO-268 (IXGT) Outline

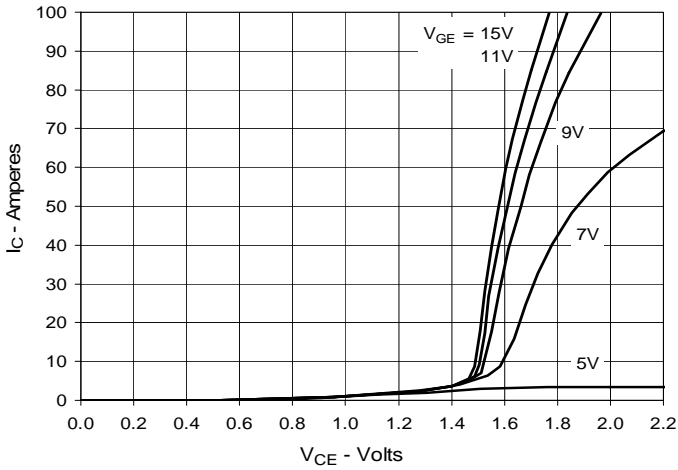


SYM	INCHES		MILLIMETERS	
	MIN	MAX	MIN	MAX
A	.193	.201	4.90	5.10
A <sub>1</sub>	.106	.114	2.70	2.90
A <sub>2</sub>	.001	.010	0.02	0.25
b	.045	.057	1.15	1.45
b <sub>2</sub>	.075	.083	1.90	2.10
C	.016	.026	0.40	0.65
C <sub>2</sub>	.057	.063	1.45	1.60
D	.543	.551	13.80	14.00
D <sub>1</sub>	.488	.500	12.40	12.70
E	.624	.632	15.85	16.05
E <sub>1</sub>	.524	.535	13.30	13.60
e		.215 BSC		5.45 BSC
H	.736	.752	18.70	19.10
L	.094	.106	2.40	2.70
L <sub>1</sub>	.047	.055	1.20	1.40
L <sub>2</sub>	.039	.045	1.00	1.15
L <sub>3</sub>		.010 BSC		0.25 BSC
L <sub>4</sub>	.150	.161	3.80	4.10

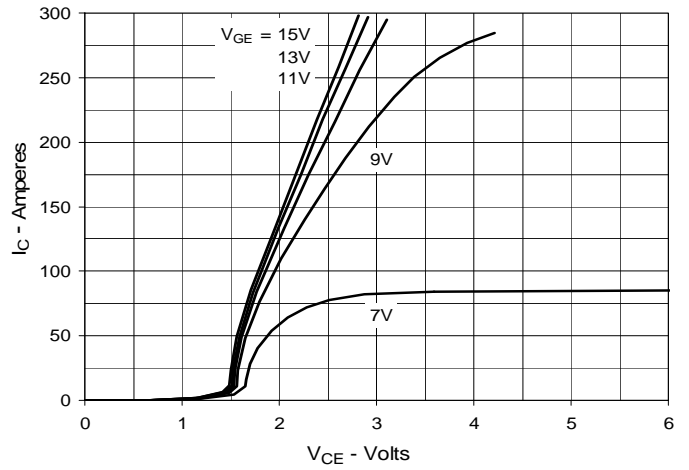
IXYS reserves the right to change limits, test conditions and dimensions.

IXYS MOSFETs and IGBTs are covered 4,835,592 4,931,844 5,049,961 5,237,481 6,162,665 6,404,065 B1 6,683,344 6,727,585 7,005,734 B2 7,157,338B2  
by one or more of the following U.S. patents: 4,850,072 5,017,508 5,063,307 5,381,025 6,259,123 B1 6,534,343 6,710,405 B2 6,759,692 7,063,975 B2  
4,881,106 5,034,796 5,187,117 5,486,715 6,306,728 B1 6,583,505 6,710,463 6,771,478 B2 7,071,537

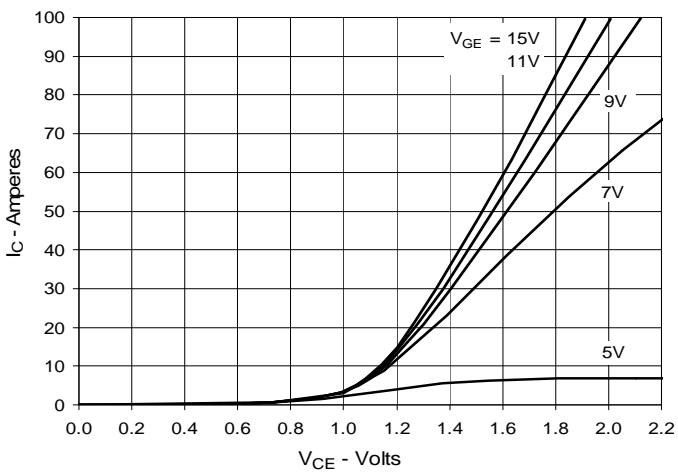
**Fig. 1. Output Characteristics @ 25°C**



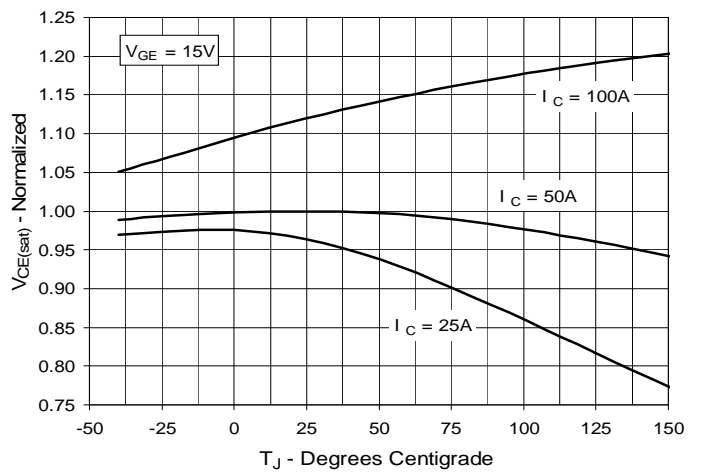
**Fig. 2. Extended Output Characteristics @ 25°C**



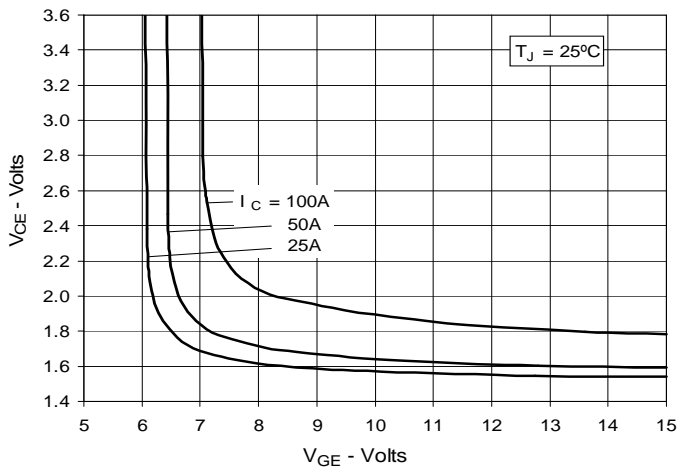
**Fig. 3. Output Characteristics @ 125°C**



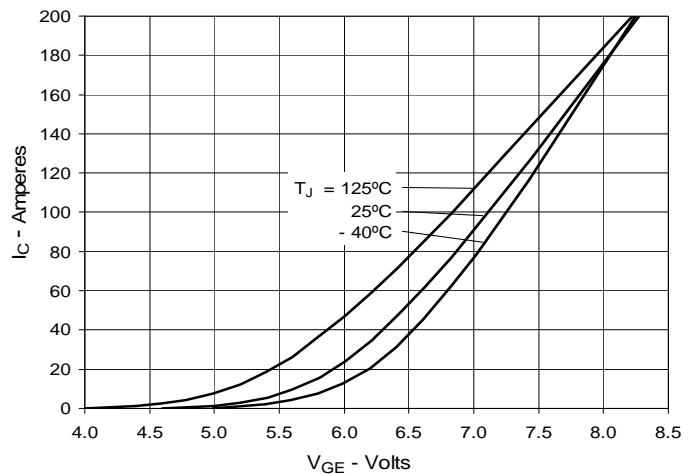
**Fig. 4. Dependence of  $V_{CE(sat)}$  on Junction Temperature**



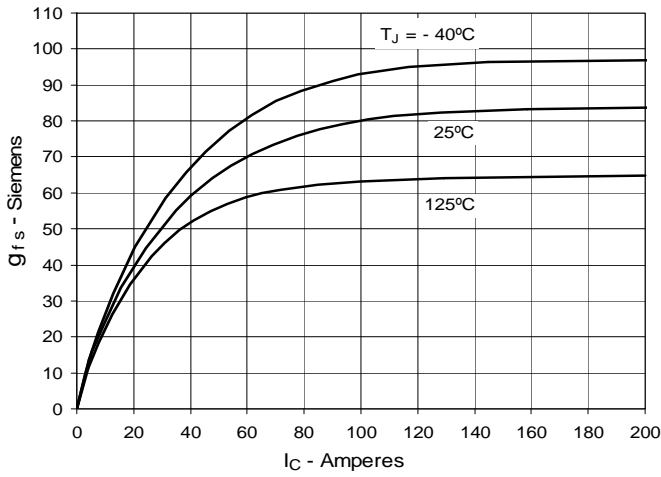
**Fig. 5. Collector-to-Emitter Voltage vs. Gate-to-Emitter Voltage**



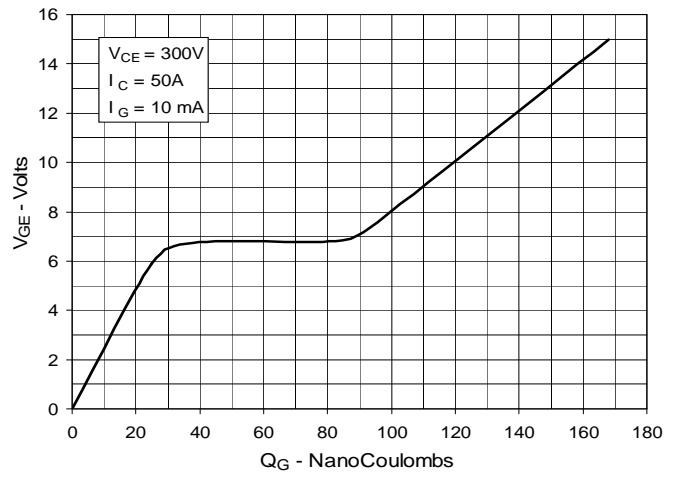
**Fig. 6. Input Admittance**



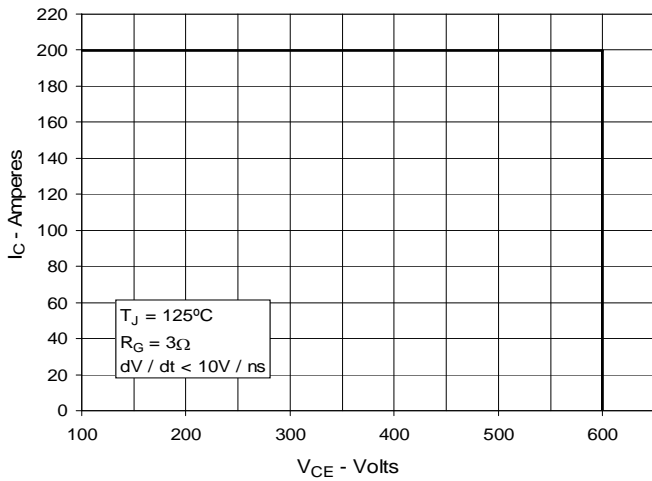
**Fig. 7. Transconductance**



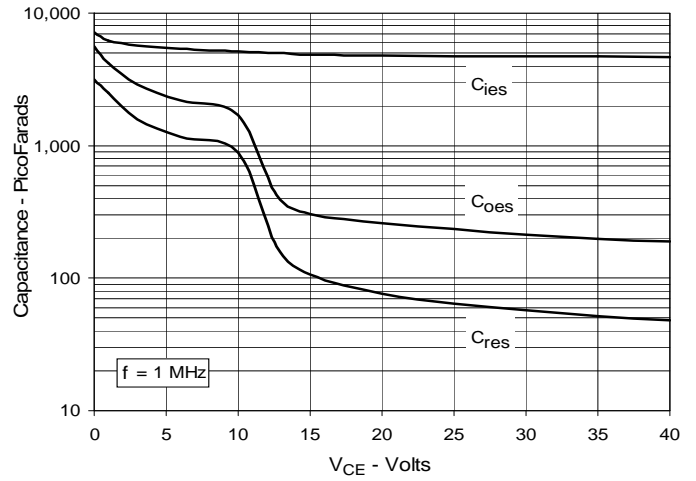
**Fig. 8. Gate Charge**



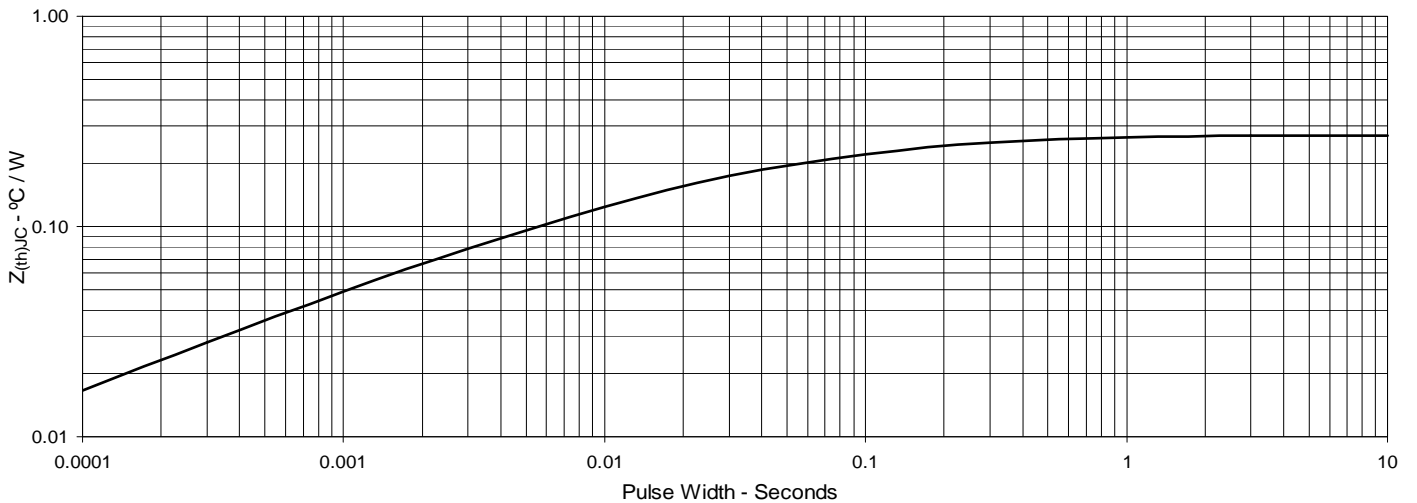
**Fig. 9. Reverse-Bias Safe Operating Area**



**Fig. 10. Capacitance**

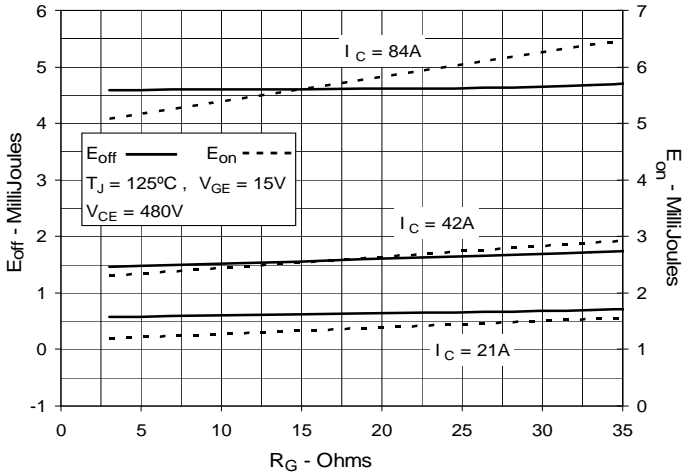


**Fig. 11. Maximum Transient Thermal Impedance**

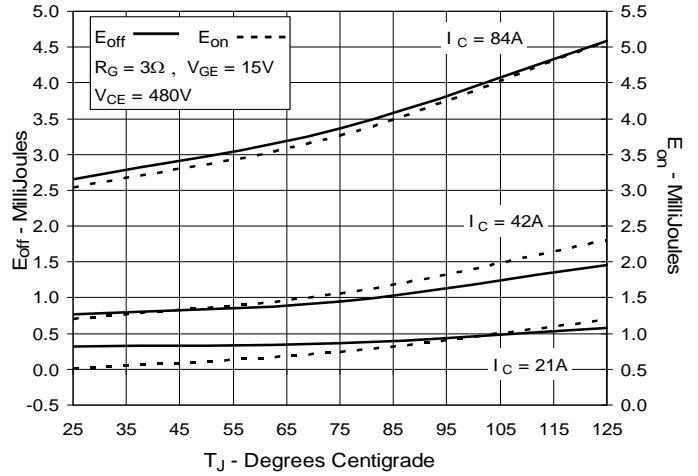


IXYS reserves the right to change limits, test conditions and dimensions.

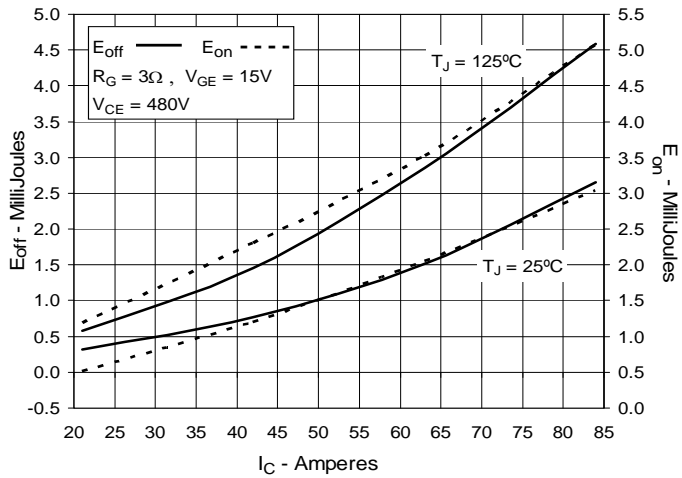
**Fig. 12. Inductive Switching Energy Loss vs. Gate Resistance**



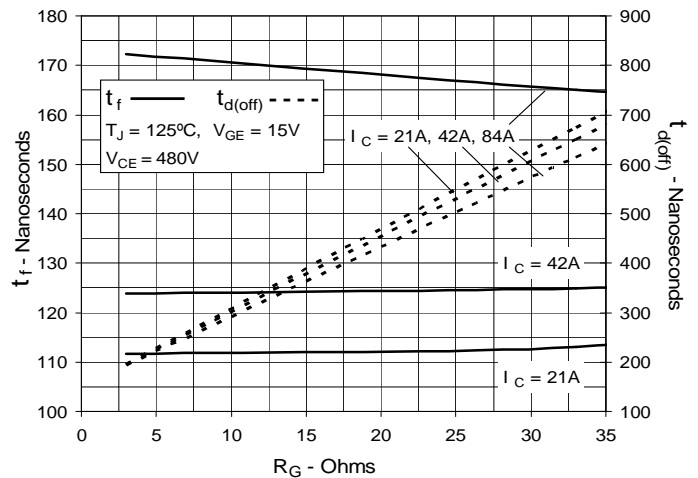
**Fig. 13. Inductive Switching Energy Loss vs. Junction Temperature**



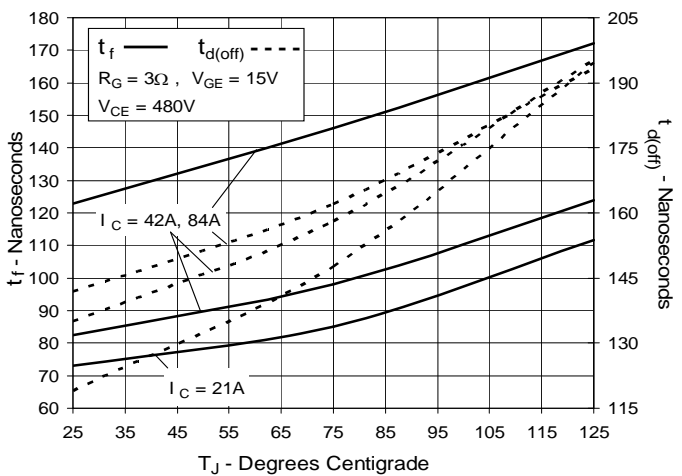
**Fig. 14. Inductive Switching Energy Loss vs. Collector Current**



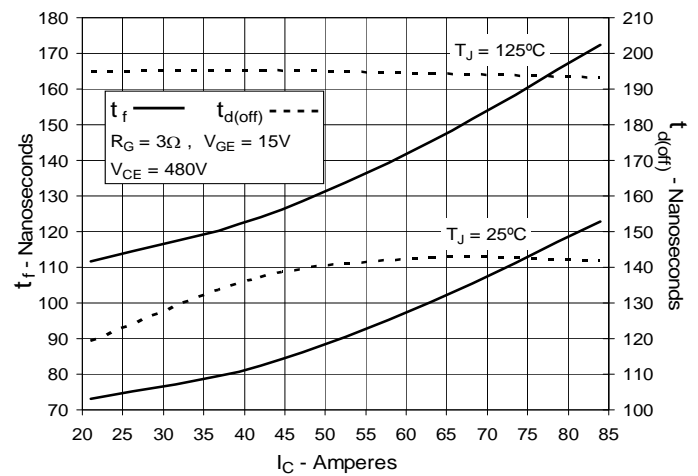
**Fig. 15. Inductive Turn-off Switching Times vs. Gate Resistance**



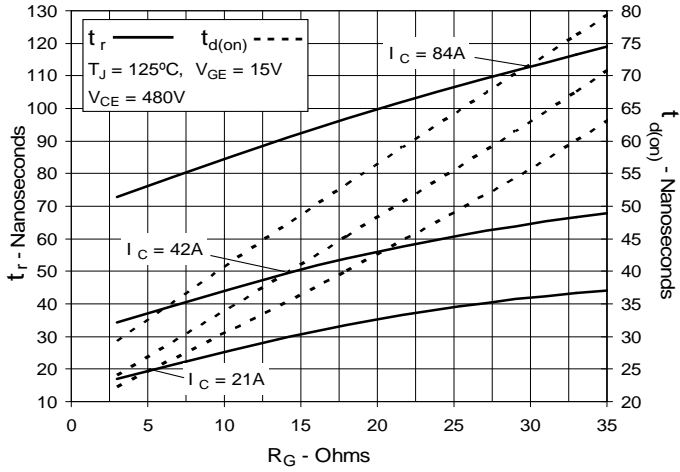
**Fig. 16. Inductive Turn-off Switching Times vs. Junction Temperature**



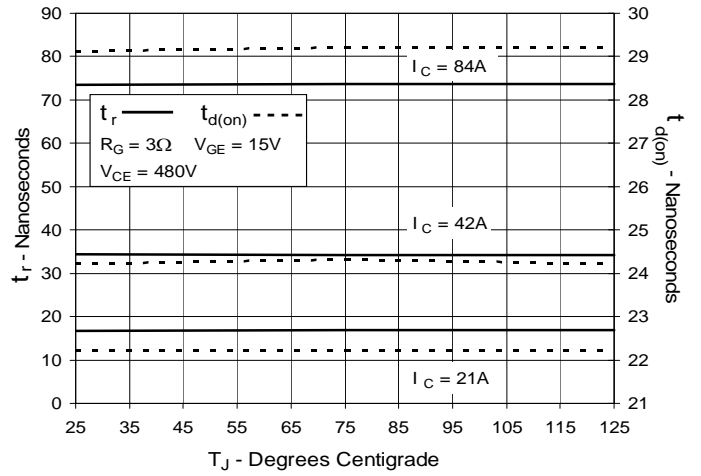
**Fig. 17. Inductive Turn-off Switching Times vs. Collector Current**



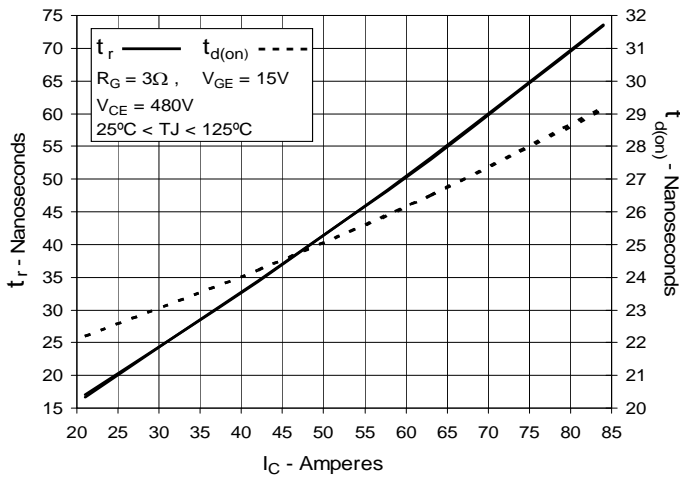
**Fig. 18. Inductive Turn-on Switching Times vs. Gate Resistance**



**Fig. 19. Inductive Turn-on Switching Times vs. Junction Temperature**



**Fig. 20. Inductive Turn-on Switching Times vs. Collector Current**





---

Disclaimer Notice - Information furnished is believed to be accurate and reliable. However, users should independently evaluate the suitability of and test each product selected for their own applications. Littelfuse products are not designed for, and may not be used in, all applications. Read complete Disclaimer Notice at [www.littelfuse.com/disclaimer-electronics](http://www.littelfuse.com/disclaimer-electronics).