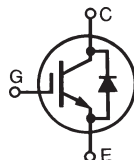

**GenX3™ 600V IGBT  
w/Diode**
**IXGK72N60A3H1  
IXGX72N60A3H1\***

\*Obsolete Part Number

 Ultra-Low V<sub>sat</sub> PT IGBTs for  
up to 5kHz Switching

$$\begin{aligned}
 V_{CES} &= 600V \\
 I_{C110} &= 72A \\
 V_{CE(sat)} &\leq 1.35V \\
 t_{fi(typ)} &= 250ns
 \end{aligned}$$

Symbol	Test Conditions	Maximum Ratings	
$V_{CES}$	$T_J = 25^\circ\text{C to } 150^\circ\text{C}$	600	V
$V_{CGR}$	$T_J = 25^\circ\text{C to } 150^\circ\text{C}, R_{GE} = 1M\Omega$	600	V
$V_{GES}$	Continuous	$\pm 20$	V
$V_{GEM}$	Transient	$\pm 30$	V
$I_{C25}$	$T_C = 25^\circ\text{C}$	75	A
$I_{C110}$	$T_C = 110^\circ\text{C}$	72	A
$I_{F110}$	$T_C = 110^\circ\text{C}$	68	A
$I_{CM}$	$T_C = 25^\circ\text{C}, 1\text{ms}$	400	A
<b>SSOA</b>	$V_{GE} = 15V, T_{VJ} = 125^\circ\text{C}, R_G = 3\Omega$	$I_{CM} = 150$	A
<b>(RBSOA)</b>	Clamped Inductive Load	$V_{CE} \leq V_{CES}$	
$P_C$	$T_C = 25^\circ\text{C}$	540	W
$T_J$		-55 ... +150	$^\circ\text{C}$
$T_{JM}$		150	$^\circ\text{C}$
$T_{stg}$		-55 ... +150	$^\circ\text{C}$
$M_d$	Mounting Torque (TO-264)	1.13 / 10	Nm/lb.in
$F_C$	Mounting Force (PLUS247)	20..120 / 4.5..27	N/lb
$T_L$	Maximum Lead Temperature for Soldering	300	$^\circ\text{C}$
$T_{SOLD}$	1.6mm (0.062 in.) from Case for 10s	260	$^\circ\text{C}$
<b>Weight</b>	TO-264	10	g
	PLUS247	6	g

TO-264 (IXGK)

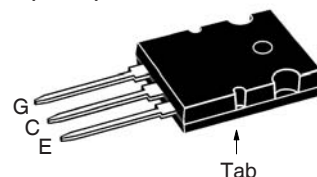

PLUS247 (IXGX)

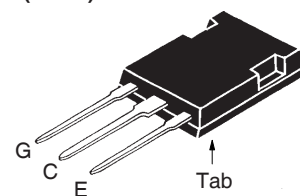

G = Gate                      E = Emitter  
 C = Collector                Tab = Collector

**Features**

- Optimized for Low Conduction Losses
- Square RBSOA
- Anti-Parallel Ultra Fast Diode
- International Standard Packages

**Advantages**

- High Power Density
- Low Gate Drive Requirement

**Applications**

- Power Inverters
- UPS
- Motor Drives
- SMPS
- PFC Circuits
- Battery Chargers
- Welding Machines
- Lamp Ballasts
- Inrush Current Protection Circuits

Symbol	Test Conditions ( $T_J = 25^\circ\text{C}$ , Unless Otherwise Specified)	Characteristic Values		
		Min.	Typ.	Max.
$V_{GE(th)}$	$I_C = 250\mu\text{A}, V_{CE} = V_{GE}$	3.0		5.0 V
$I_{CES}$	$V_{CE} = V_{CES}, V_{GE} = 0V$ $T_J = 125^\circ\text{C}$			300 $\mu\text{A}$ 5 mA
$I_{GES}$	$V_{CE} = 0V, V_{GE} = \pm 20V$			$\pm 100$ nA
$V_{CE(sat)}$	$I_C = 60A, V_{GE} = 15V, \text{Note 1}$			1.35 V

Symbol	Test Conditions	Characteristic Values		
		Min.	Typ.	Max.
$g_{fs}$	$I_C = 60A, V_{CE} = 10V$ , Note 1	48	75	S
$C_{ies}$	$V_{CE} = 25V, V_{GE} = 0V, f = 1MHz$		6600	pF
$C_{oes}$			360	pF
$C_{res}$			80	pF
$Q_{g(on)}$	$I_C = 60A, V_{GE} = 15V, V_{CE} = 0.5 \cdot V_{CES}$		230	nC
$Q_{ge}$			40	nC
$Q_{gc}$			80	nC
$t_{d(on)}$	<b>Inductive load, <math>T_J = 25^\circ C</math></b> $I_C = 50A, V_{GE} = 15V$ $V_{CE} = 480V, R_G = 3\Omega$		31	ns
$t_{ri}$			34	ns
$E_{on}$			1.4	mJ
$t_{d(off)}$			320	ns
$t_{fi}$			250	ns
$E_{off}$			3.5	mJ
$t_{d(on)}$	<b>Inductive load, <math>T_J = 125^\circ C</math></b> $I_C = 50A, V_{GE} = 15V$ $V_{CE} = 480V, R_G = 3\Omega$		29	ns
$t_{ri}$			34	ns
$E_{on}$			2.6	mJ
$t_{d(off)}$			510	ns
$t_{fi}$			375	ns
$E_{off}$			6.5	mJ
$R_{thJC}$			0.23	$^\circ C/W$
$R_{thCS}$		0.15		$^\circ C/W$

### Reverse Diode (FRED)

Symbol	Test Conditions	Characteristic Values		
		Min.	Typ.	Max.
$V_F$	$I_F = 60A, V_{GE} = 0V$ , Note 1		1.6	2.3 V
	$T_J = 150^\circ C$		1.4	1.8 V
$I_{RM}$	$I_F = 60A, V_{GE} = 0V$ , $T_J = 100^\circ C$		8.3	A
$t_{rr}$	$I_F = 60A, -di/dt = 200A/\mu s, V_R = 300V$		140	ns
$R_{thJC}$				0.3 $^\circ C/W$

Note 1: Pulse test,  $t \leq 300\mu s$ , duty cycle,  $d \leq 2\%$ .

### PRELIMINARY TECHNICAL INFORMATION

The product presented herein is under development. The Technical Specifications offered are derived from a subjective evaluation of the design, based upon prior knowledge and experience, and constitute a "considered reflection" of the anticipated result. IXYS reserves the right to change limits, test conditions, and dimensions without notice.

### TO-264 Outline

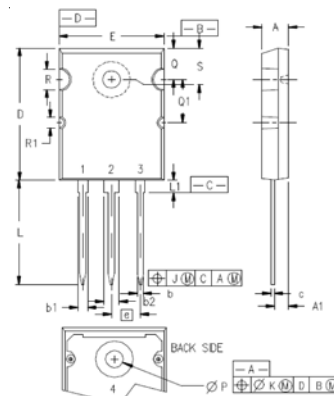

Terminals: 1 = Gate  
2,4 = Collector  
3 = Emitter

SYM	INCHES		MILLIMETERS	
	MIN	MAX	MIN	MAX
A	.185	.209	4.70	5.31
A1	.102	.118	2.59	3.00
b	.037	.055	0.94	1.40
b1	.087	.102	2.21	2.59
b2	.110	.126	2.79	3.20
c	.017	.029	0.43	0.74
D	1.007	1.047	25.58	26.59
E	.760	.799	19.30	20.29
e	.215 BSC		5.46 BSC	
J	.000	.010	0.00	0.25
K	.000	.010	0.00	0.25
L	.779	.842	19.79	21.39
L1	.087	.102	2.21	2.59
ØP	.122	.138	3.10	3.51
Q	.240	.256	6.10	6.50
Q1	.330	.346	8.38	8.79
ØR	.155	.187	3.94	4.75
ØR1	.085	.093	2.16	2.36
S	.243	.253	6.17	6.43

### PLUS247™ Outline

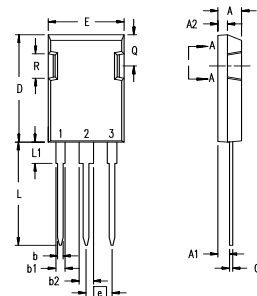

Terminals: 1 - Gate  
2 - Collector  
3 - Emitter

Dim.	Millimeter		Inches	
	Min.	Max.	Min.	Max.
A	4.83	5.21	.190	.205
A <sub>1</sub>	2.29	2.54	.090	.100
A <sub>2</sub>	1.91	2.16	.075	.085
b	1.14	1.40	.045	.055
b <sub>1</sub>	1.91	2.13	.075	.084
b <sub>2</sub>	2.92	3.12	.115	.123
C	0.61	0.80	.024	.031
D	20.80	21.34	.819	.840
E	15.75	16.13	.620	.635
e	5.45 BSC		.215 BSC	
L	19.81	20.32	.780	.800
L1	3.81	4.32	.150	.170
Q	5.59	6.20	.220	0.244
R	4.32	4.83	.170	.190

IXYS Reserves the Right to Change Limits, Test conditions, and Dimensions.

IXYS MOSFETs and IGBTs are covered by one or more of the following U.S. patents:	4,835,592	4,931,844	5,049,961	5,237,481	6,162,665	6,404,065 B1	6,683,344	6,727,585	7,005,734 B2	7,157,338 B2
	4,860,072	5,017,508	5,063,307	5,381,025	6,259,123 B1	6,534,343	6,710,405 B2	6,759,692	7,063,975 B2	
	4,881,106	5,034,796	5,187,117	5,486,715	6,306,728 B1	6,583,505	6,710,463	6,771,478 B2	7,071,537	

Fig. 1. Output Characteristics @  $T_J = 25^\circ\text{C}$

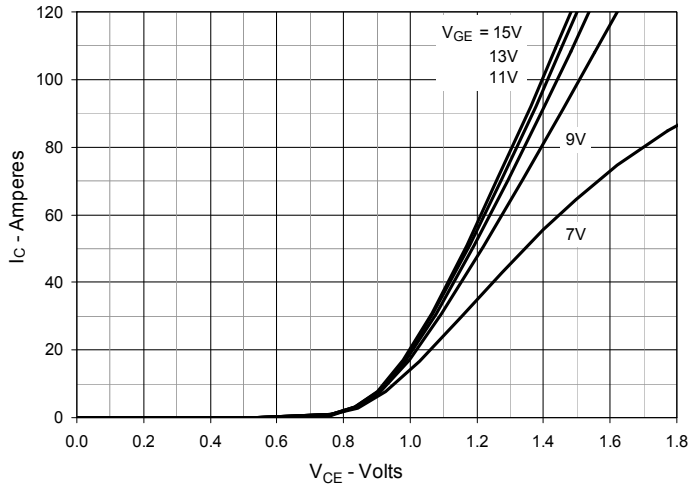

Fig. 2. Extended Output Characteristics @  $T_J = 25^\circ\text{C}$

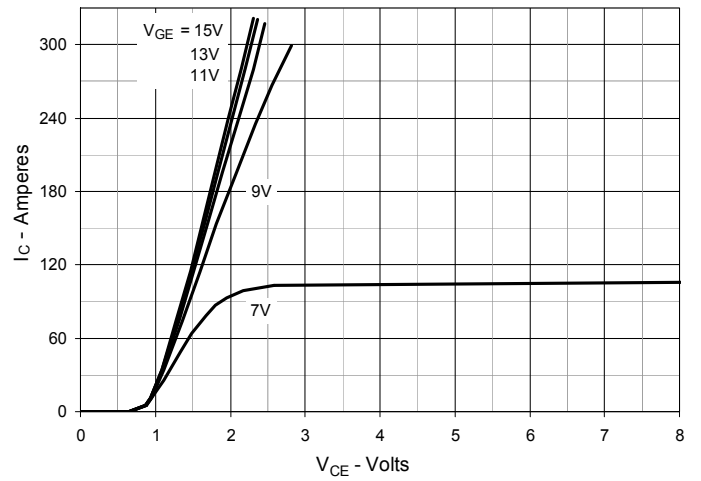

Fig. 3. Output Characteristics @  $T_J = 125^\circ\text{C}$

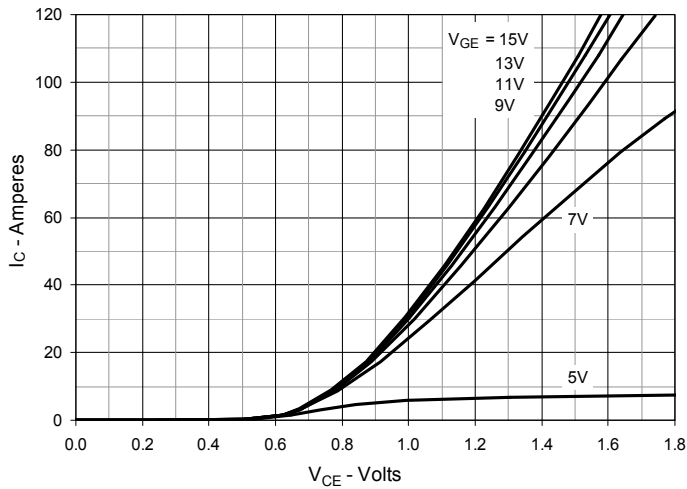

Fig. 4. Dependence of  $V_{CE(sat)}$  on Junction Temperature

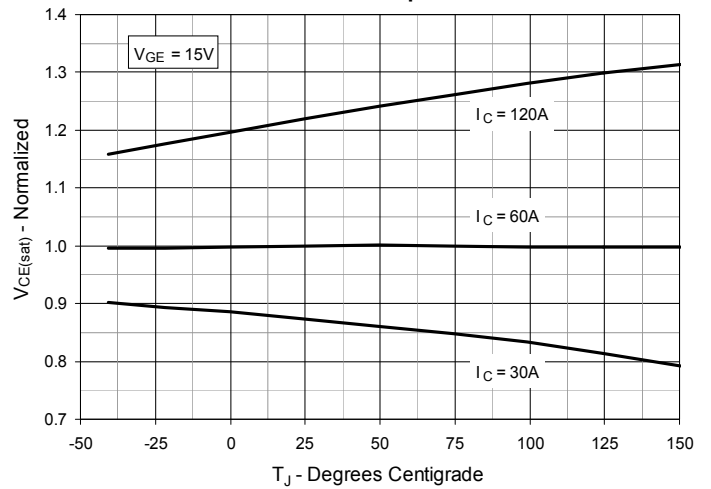

Fig. 5. Collector-to-Emitter Voltage vs. Gate-to-Emitter Voltage

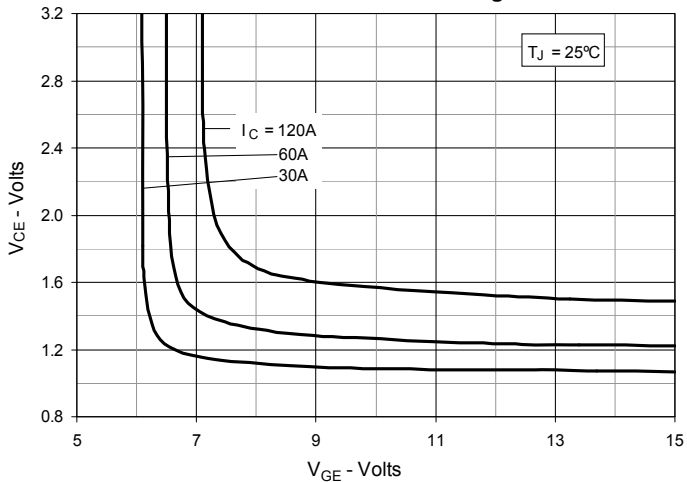

Fig. 6. Input Admittance

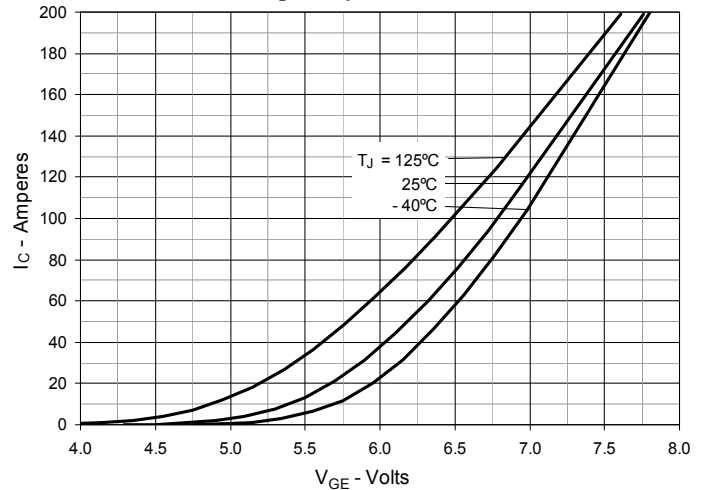

Fig. 7. Transconductance

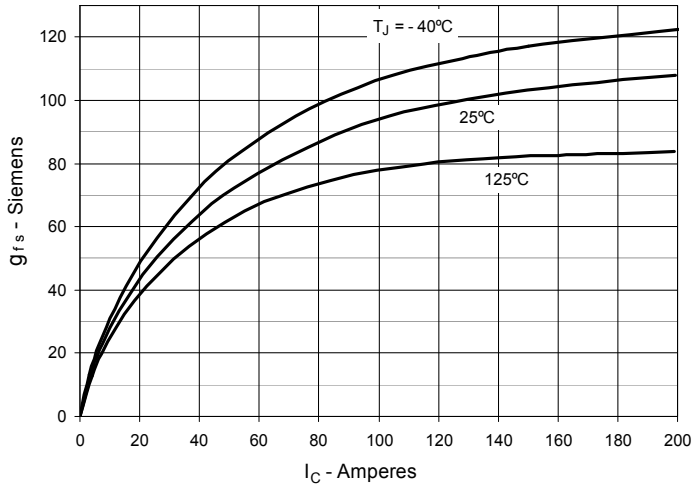

Fig. 8. Gate Charge

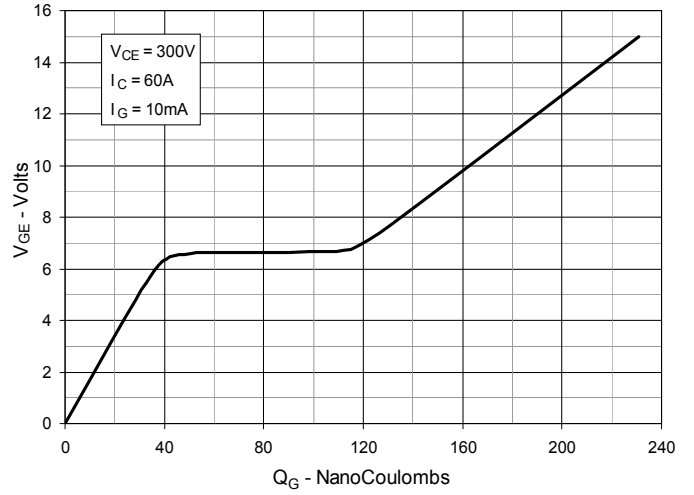

Fig. 9. Capacitance

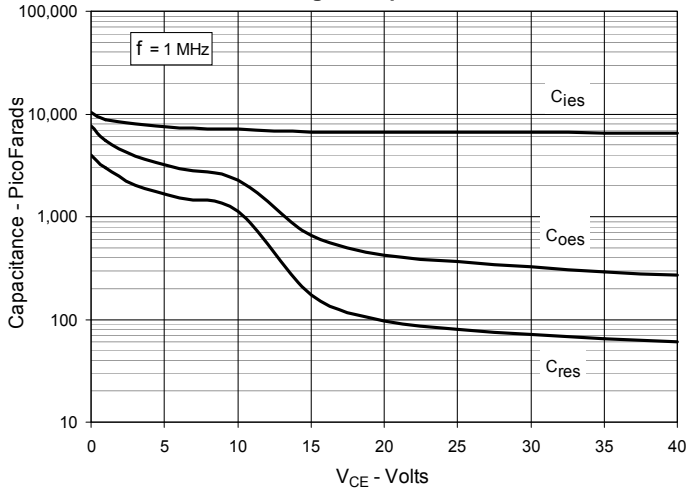

Fig. 10. Reverse-Bias Safe Operating Area

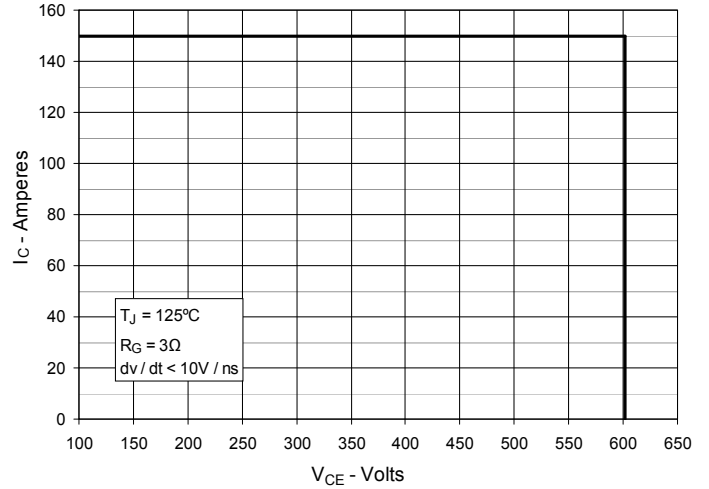
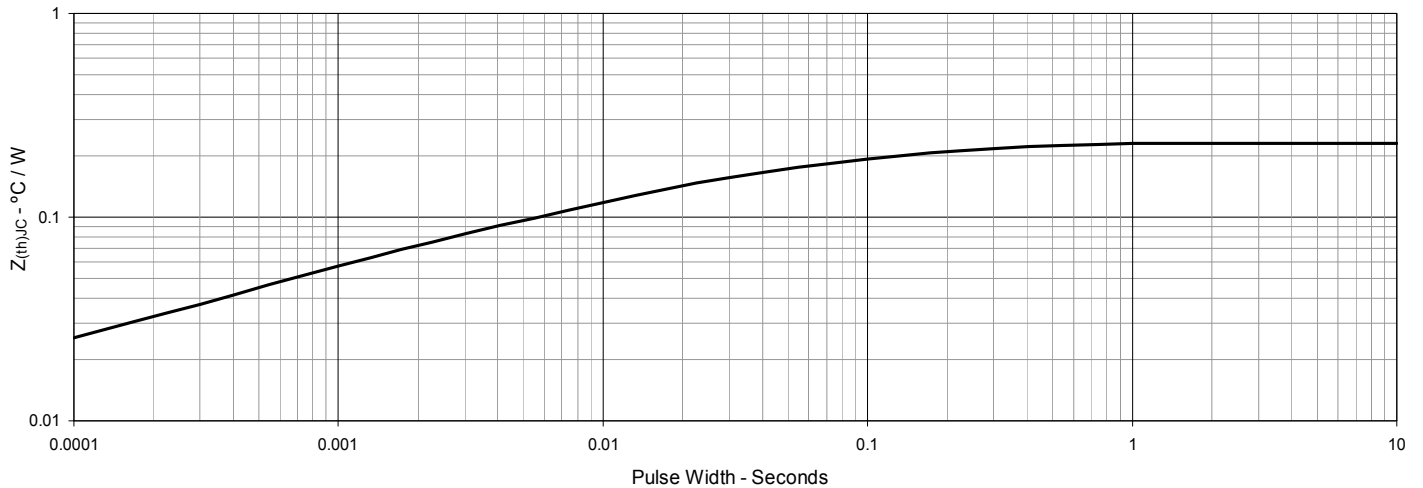
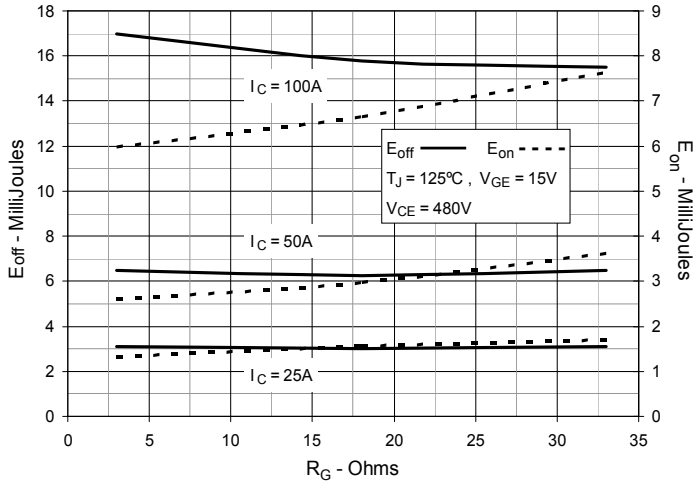

Fig. 11. Maximum Transient Thermal Impedance



**Fig. 12. Inductive Switching Energy Loss vs. Gate Resistance**



**Fig. 13. Inductive Switching Energy Loss vs. Collector Current**

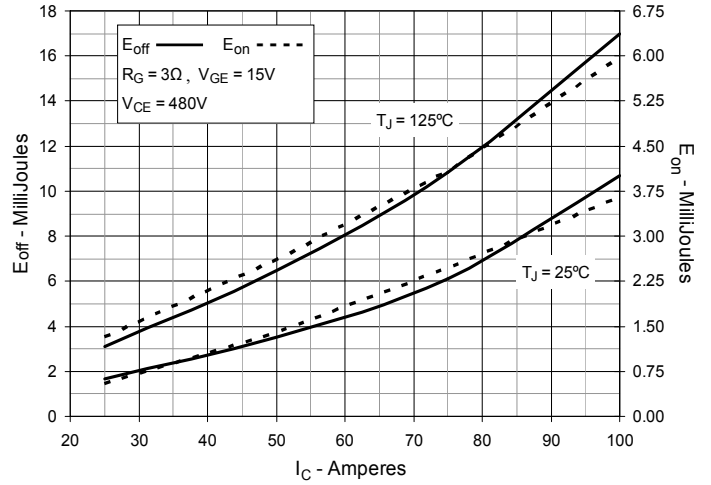

**Fig. 14. Inductive Switching Energy Loss vs. Junction Temperature**

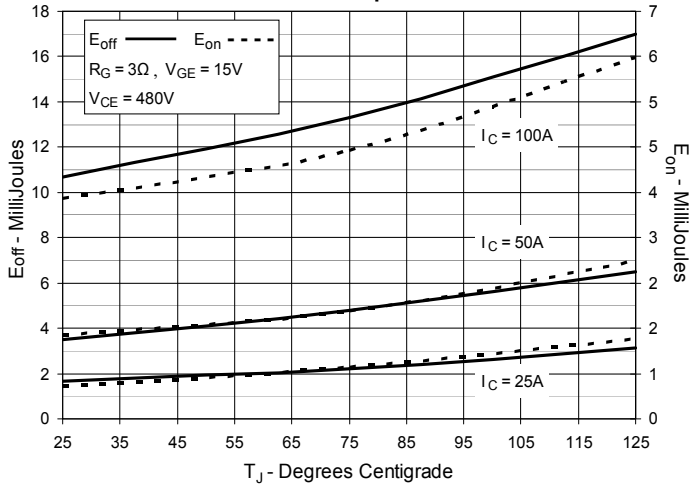

**Fig. 15. Inductive Turn-off Switching Times vs. Gate Resistance**

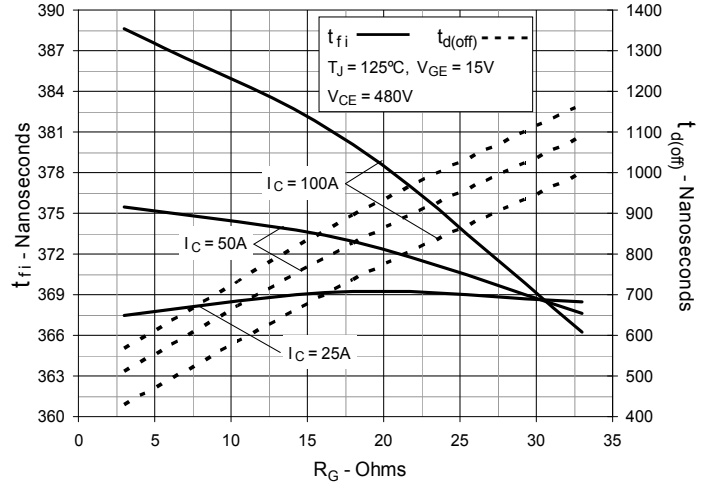

**Fig. 16. Inductive Turn-off Switching Times vs. Collector Current**

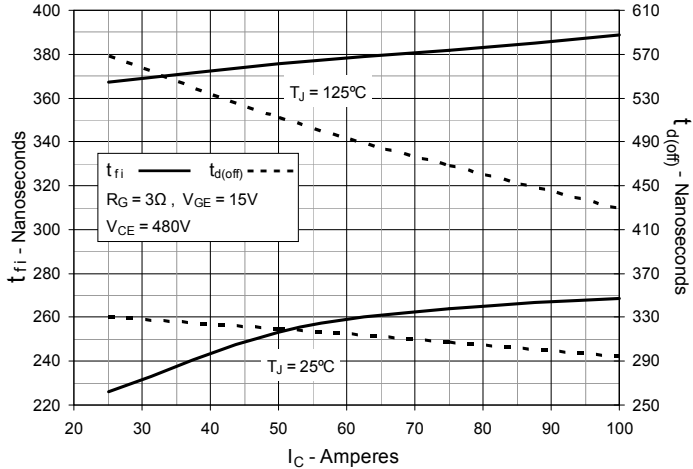

**Fig. 17. Inductive Turn-off Switching Times vs. Junction Temperature**

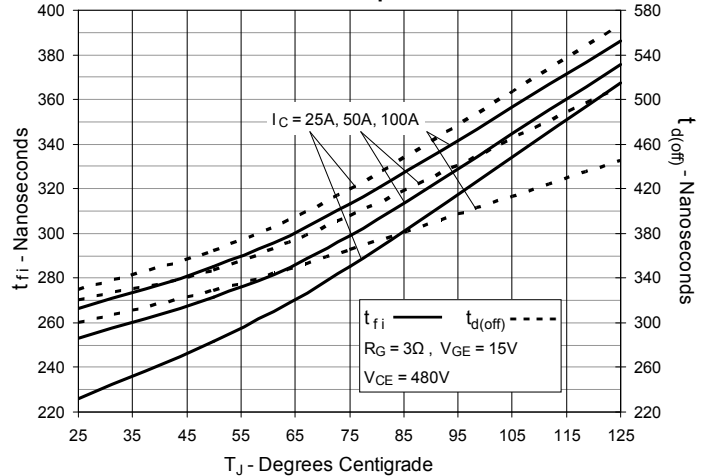

**Fig. 18. Inductive Turn-on Switching Times vs. Gate Resistance**

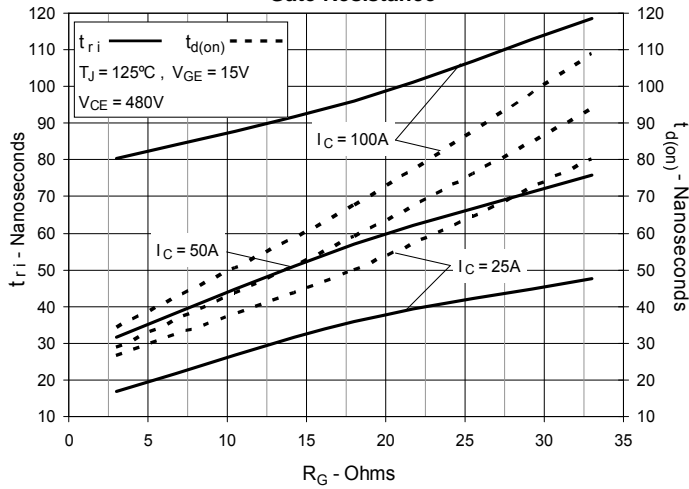

**Fig. 19. Inductive Turn-on Switching Times vs. Collector Current**

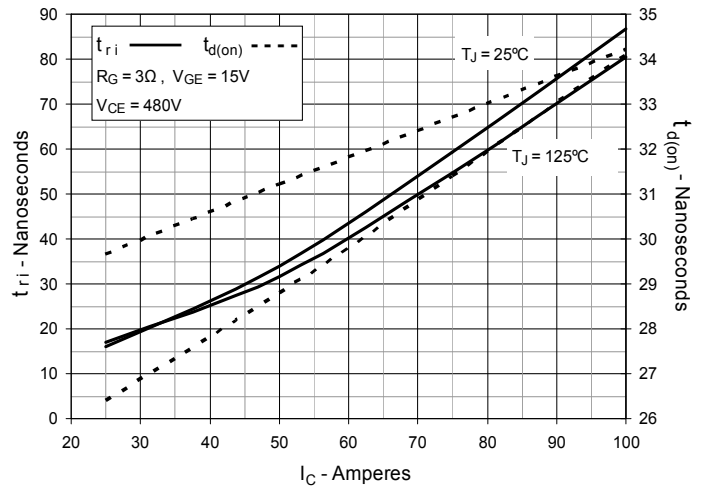

**Fig. 20. Inductive Turn-on Switching Times vs. Junction Temperature**

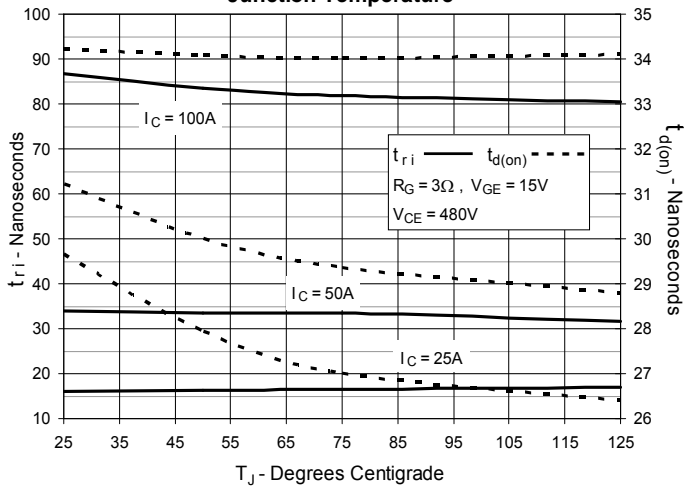

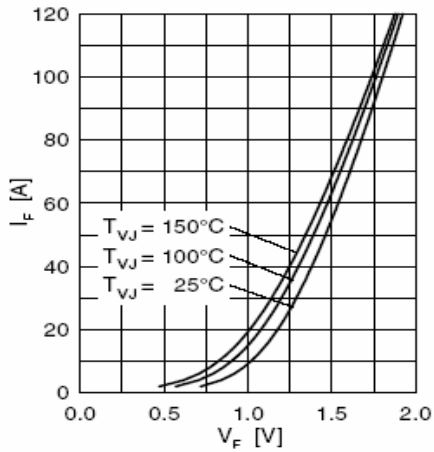

Fig. 21 Forward current  $I_F$  vs.  $V_F$

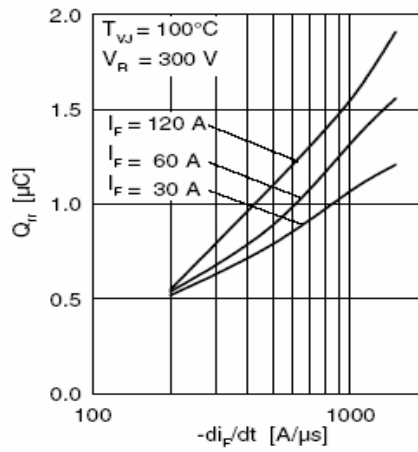

Fig. 22 Typ. reverse recovery charge  $Q_{rr}$

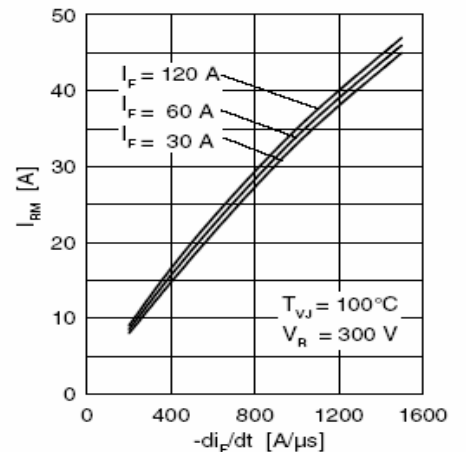

Fig. 23 Typ. peak reverse current  $I_{RM}$



Fig. 24 Typ. dynamic parameters  $Q_{rr}$ ,  $I_{RM}$



Fig. 25 Typ. recovery time  $t_{rr}$

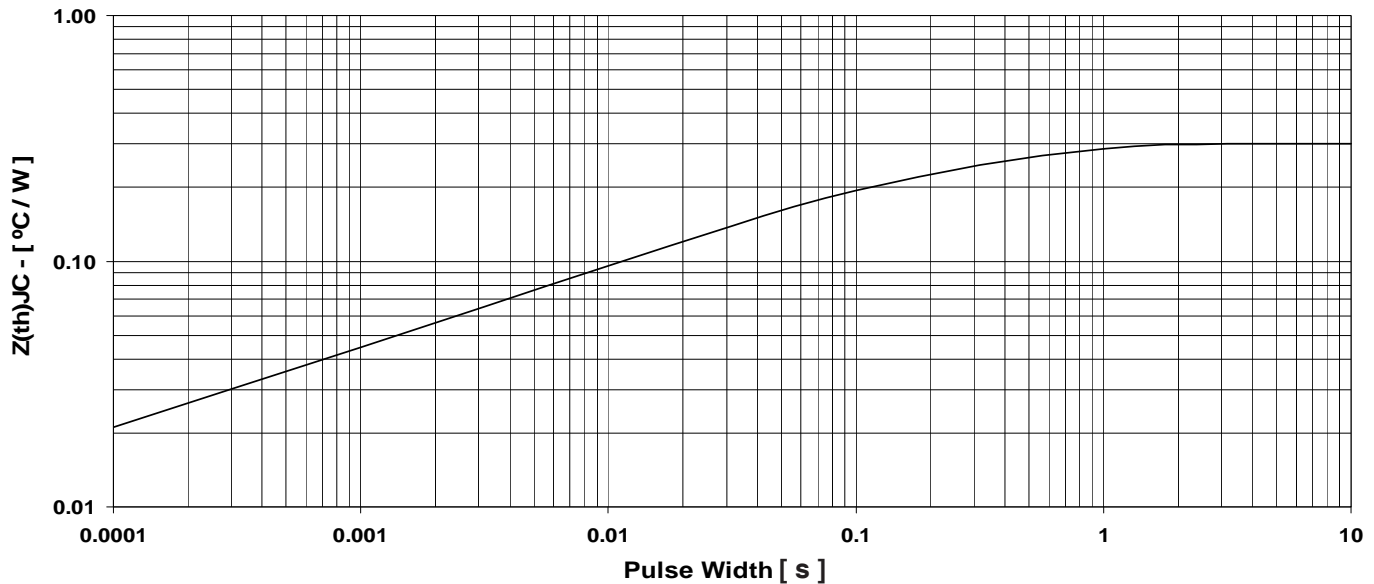

Fig. 26 Maximum transient thermal impedance junction to case (for diode)



---

Disclaimer Notice - Information furnished is believed to be accurate and reliable. However, users should independently evaluate the suitability of and test each product selected for their own applications. Littelfuse products are not designed for, and may not be used in, all applications. Read complete Disclaimer Notice at [www.littelfuse.com/disclaimer-electronics](http://www.littelfuse.com/disclaimer-electronics).