

GenX3™ 300V IGBT

IXGH120N30B3*

*Obsolete Part Number

$V_{CES} = 300V$
 $I_{C110} = 120A$
 $V_{CE(sat)} \leq 1.7V$

Medium speed low V_{sat} PT IGBTs for 10-50 kHz switching

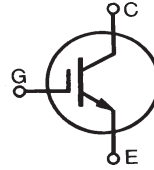

Symbol	Test Conditions	Maximum Ratings	
V_{CES}	$T_J = 25^\circ C$ to $150^\circ C$	300	V
V_{CGR}	$T_J = 25^\circ C$ to $150^\circ C$, $R_{GE} = 1M\Omega$	300	V
V_{GES}	Continuous	± 20	V
V_{GEM}	Transient	± 30	V
I_{C25}	$T_C = 25^\circ C$ (limited by leads)	75	A
I_{C110}	$T_C = 110^\circ C$	120	A
I_{CM}	$T_C = 25^\circ C$, 1ms	480	A
SSOA (RBSOA)	$V_{GE} = 15V$, $T_J = 125^\circ C$, $R_G = 1\Omega$ Clamped inductive load @ $V_{CE} \leq 300V$	$I_{CM} = 240$	A
P_C	$T_C = 25^\circ C$	540	W
T_J		-55 ... +150	$^\circ C$
T_{JM}		150	$^\circ C$
T_{stg}		-55 ... +150	$^\circ C$
M_d	Mounting torque	1.13 / 10	Nm/lb.in.
T_L	Maximum lead temperature for soldering	300	$^\circ C$
T_{SOLD}	1.6mm (0.062 in.) from case for 10s	260	$^\circ C$
Weight		6	g

TO-247 (IXGH)

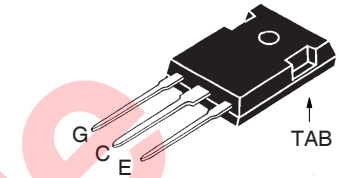

G = Gate C = Collector
 E = Emitter TAB = Collector

Features

- Optimized for low switching losses
- Square RBSOA
- International standard package

Advantages

- High power density
- Low gate drive requirement

Applications

- High Frequency Power Inverters
- UPS
- Motor Drives
- SMPS
- PFC Circuits
- Battery Chargers
- Welding Machines
- Lamp Ballasts

Symbol	Test Conditions ($T_J = 25^\circ C$, unless otherwise specified)	Characteristic Values		
		Min.	Typ.	Max.
BV_{CES}	$I_C = 250\mu A$, $V_{GE} = 0V$	300		V
$V_{GE(th)}$	$I_C = 250\mu A$, $V_{CE} = V_{GE}$	3.0		5.0 V
I_{CES}	$V_{CE} = V_{CES}$ $V_{GE} = 0V$ $T_J = 125^\circ C$			10 μA 500 μA
I_{GES}	$V_{CE} = 0V$, $V_{GE} = \pm 20V$			± 100 nA
$V_{CE(sat)}$	$I_C = 120A$, $V_{GE} = 15V$, Note 1 $T_J = 125^\circ C$	1.42	1.70	V
		1.47		V

Symbol	Test Conditions ($T_J = 25^\circ\text{C}$, unless otherwise specified)	Characteristic Values		
		Min.	Typ.	Max.
g_{fs}	$I_C = 60\text{A}, V_{CE} = 10\text{V}$, Note 1	55	90	S
C_{ies} C_{oes} C_{res}	$V_{CE} = 25\text{V}, V_{GE} = 0\text{V}, f = 1\text{MHz}$		6700	pF
			650	pF
			160	pF
Q_g Q_{ge} Q_{gc}	$I_C = 120\text{A}, V_{GE} = 15\text{V}, V_{CE} = 0.5 \cdot V_{CES}$		225	nC
			38	nC
			85	nC
$t_{d(on)}$ t_r $t_{d(off)}$ t_f	Resistive load, $T_J = 25^\circ\text{C}$ $I_C = 60\text{A}, V_{GE} = 15\text{V}$ $V_{CE} = 240\text{V}, R_G = 1\Omega$		22	ns
			27	ns
			100	ns
			64	ns
$t_{d(on)}$ t_r $t_{d(off)}$ t_f	Resistive load, $T_J = 125^\circ\text{C}$ $I_C = 60\text{A}, V_{GE} = 15\text{V}$ $V_{CE} = 240\text{V}, R_G = 1\Omega$		21	ns
			30	ns
			106	ns
			250	ns
R_{thJC} R_{thCK}			0.21	0.23°C/W $^\circ\text{C/W}$

TO-247 (IXGH) Outline

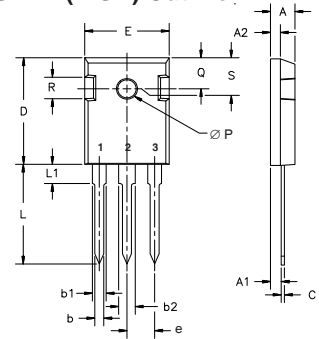

Terminals: 1 - Gate
2 - Drain
3 - Source
Tab - Drain

Dim.	Millimeter		Inches	
	Min.	Max.	Min.	Max.
A	4.7	5.3	.185	.209
A ₁	2.2	2.54	.087	.102
A ₂	2.2	2.6	.059	.098
b	1.0	1.4	.040	.055
b ₁	1.65	2.13	.065	.084
b ₂	2.87	3.12	.113	.123
C	.4	.8	.016	.031
D	20.80	21.46	.819	.845
E	15.75	16.26	.610	.640
e	5.20	5.72	0.205	0.225
L	19.81	20.32	.780	.800
L1		4.50		.177
ØP	3.55	3.65	.140	.144
Q	5.89	6.40	0.232	0.252
R	4.32	5.49	.170	.216
S	6.15	BSC	242	BSC

Notes: 1. Pulse test, $t \leq 300\mu\text{s}$; duty cycle, $d \leq 2\%$.

IXYS reserves the right to change limits, test conditions, and dimensions.

IXYS MOSFETs and IGBTs are covered by one or more of the following U.S. patents:	4,835,592	4,931,844	5,049,961	5,237,481	6,162,665	6,404,065 B1	6,683,344	6,727,585	7,005,734 B2	7,157,338B2
	4,850,072	5,017,508	5,063,307	5,381,025	6,259,123 B1	6,534,343	6,710,405 B2	6,759,692	7,063,975 B2	
	4,881,106	5,034,796	5,187,117	5,486,715	6,306,728 B1	6,583,505	6,710,463	6,771,478 B2	7,071,537	

Fig. 1. Output Characteristics @ 25°C

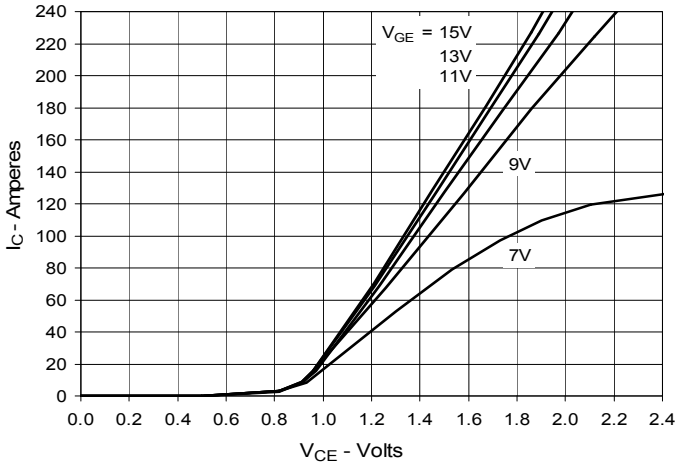

Fig. 2. Extended Output Characteristics @ 25°C

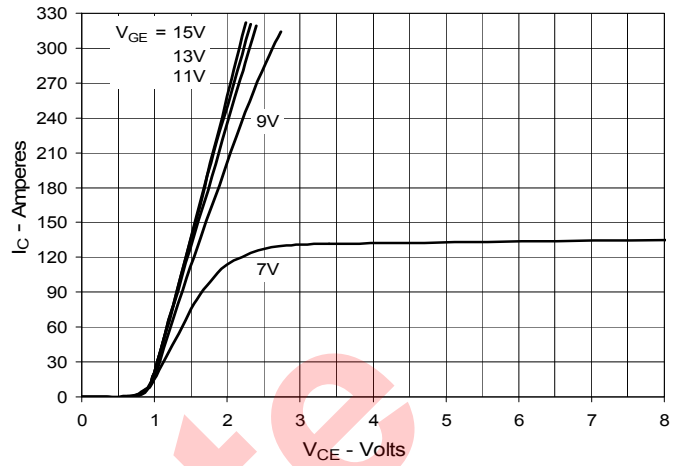

Fig. 3. Output Characteristics @ 125°C

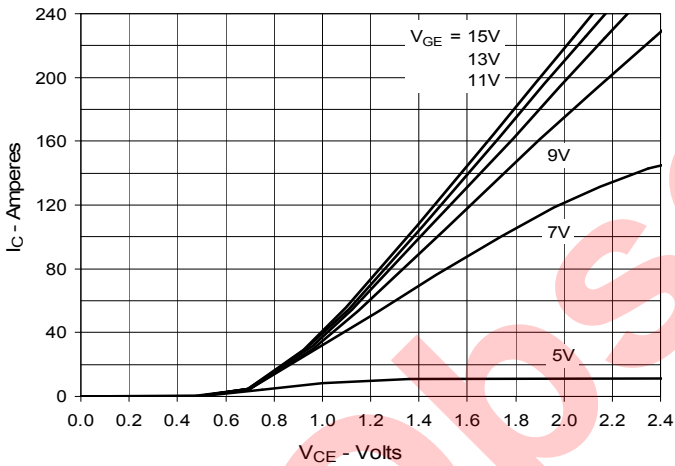

Fig. 4. Dependence of VCE(sat) on Junction Temperature

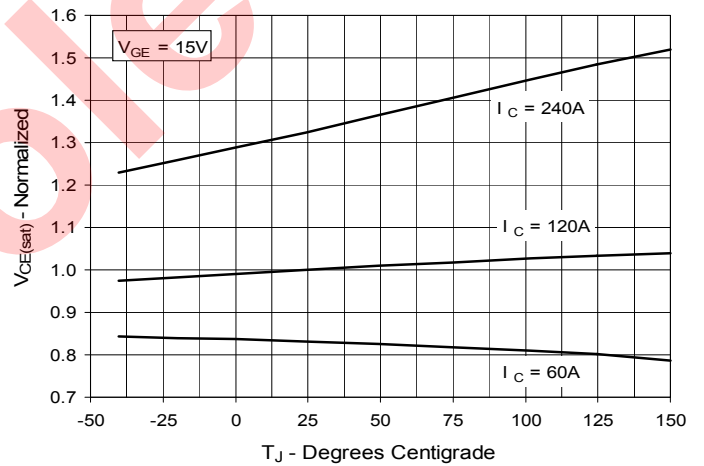

Fig. 5. Collector-to-Emitter Voltage vs. Gate-to-Emitter Voltage

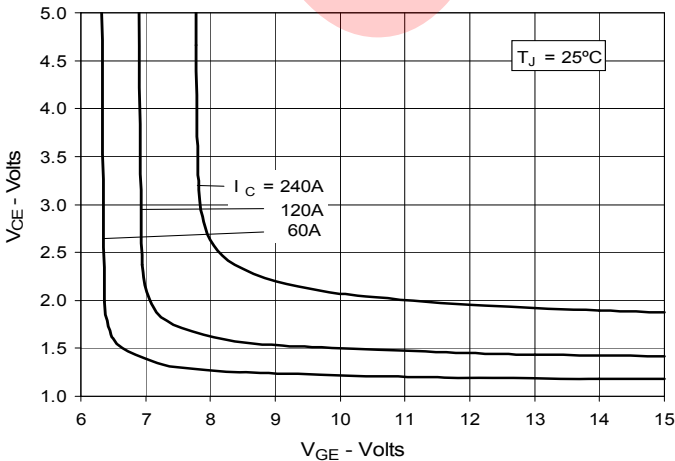

Fig. 6. Input Admittance

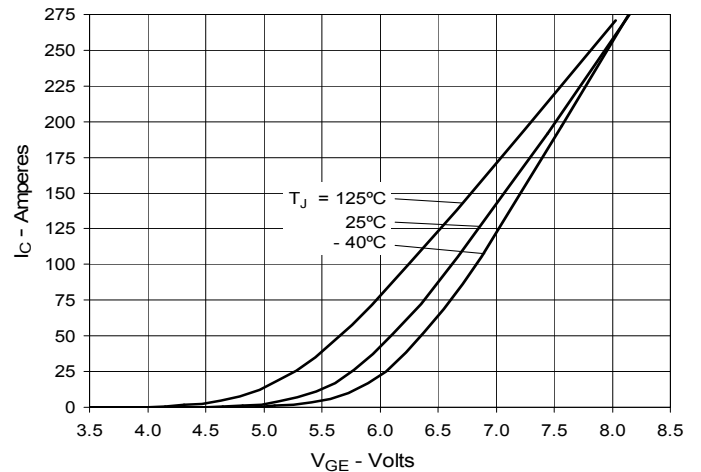

Fig. 7. Transconductance

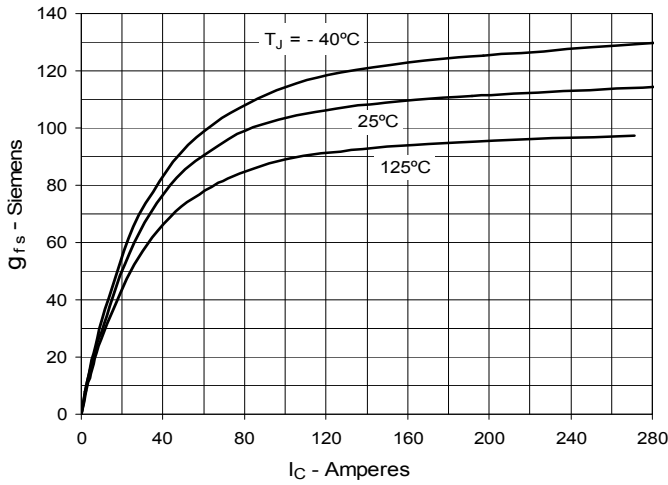

Fig. 8. Gate Charge

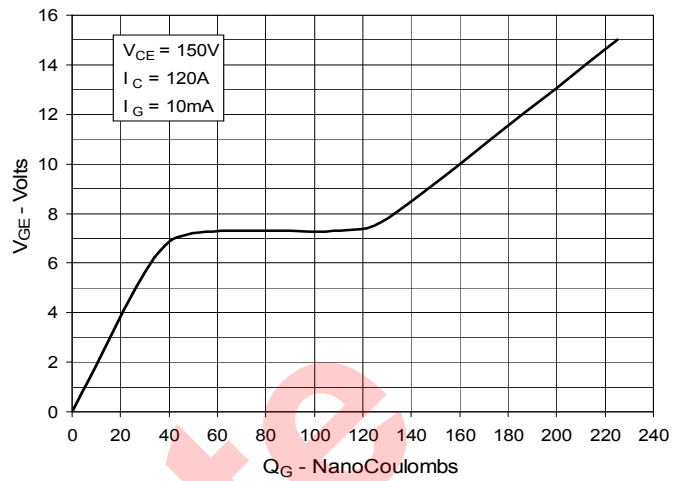

Fig. 9. Reverse-Bias Safe Operating Area

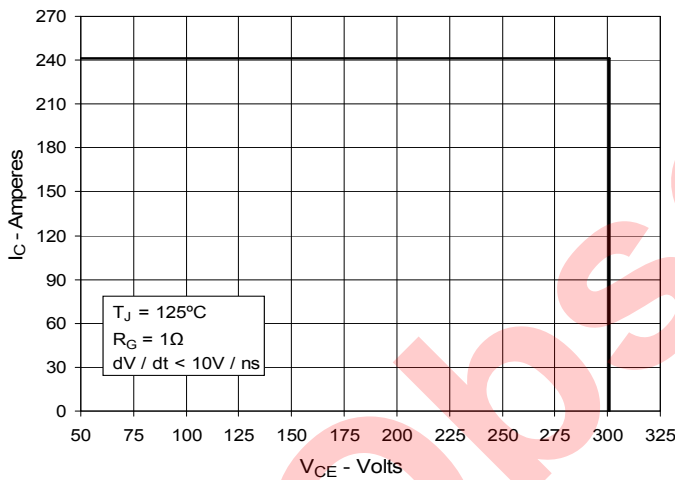

Fig. 10. Capacitance

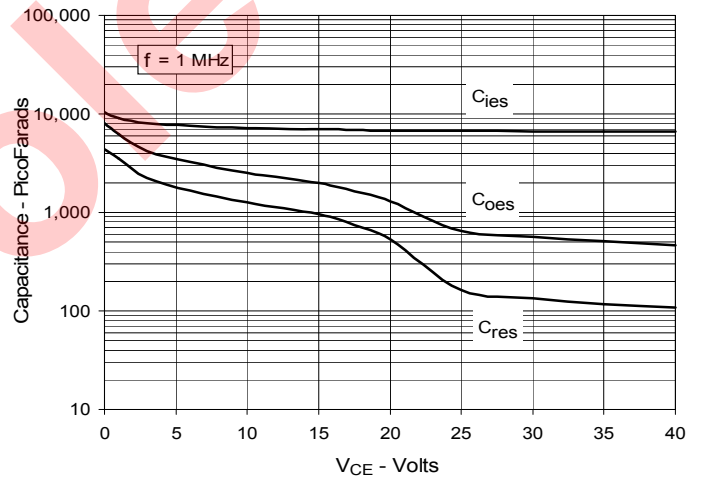
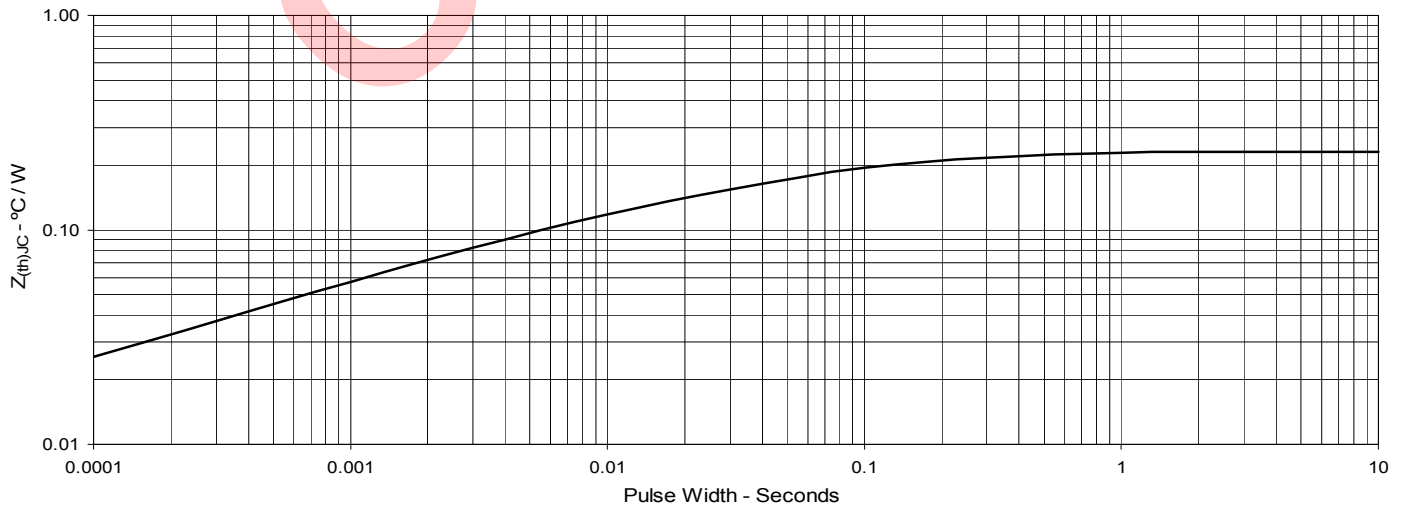
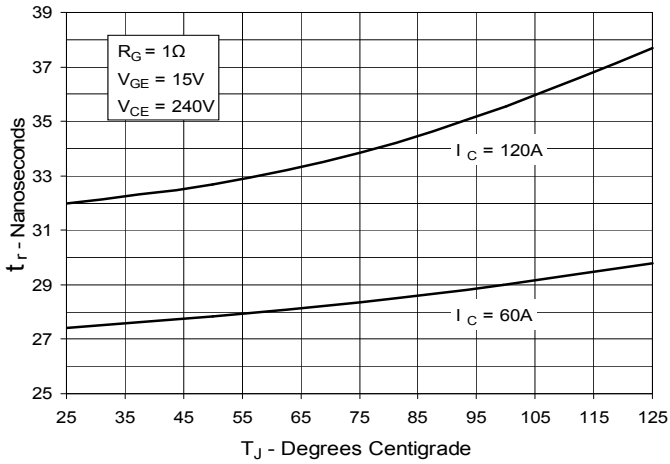
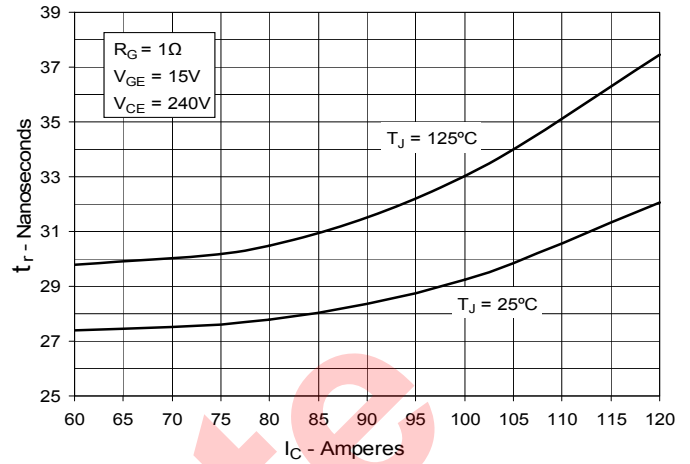
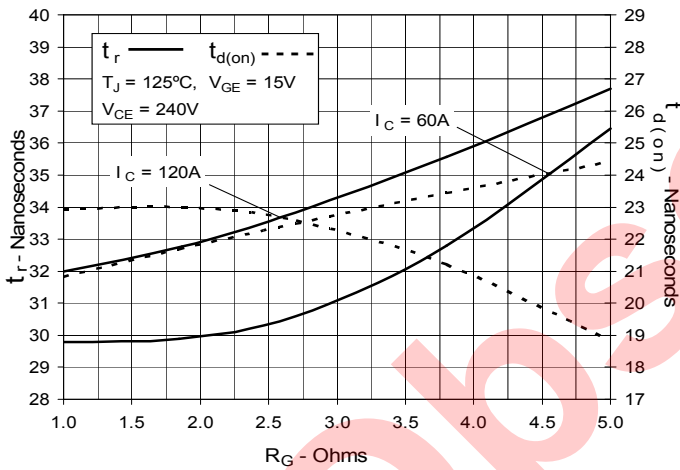
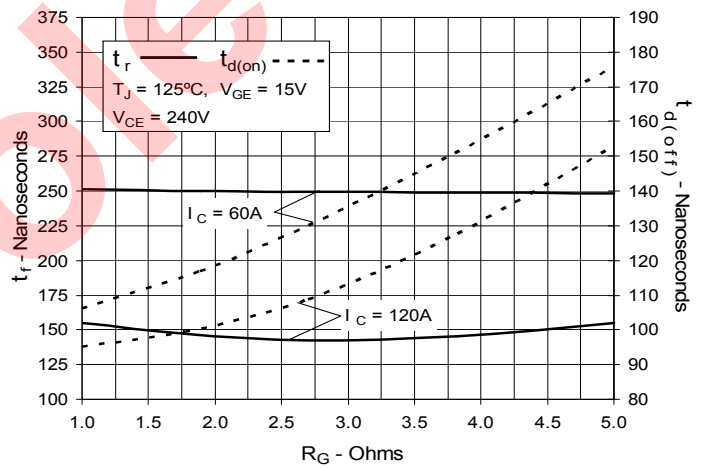
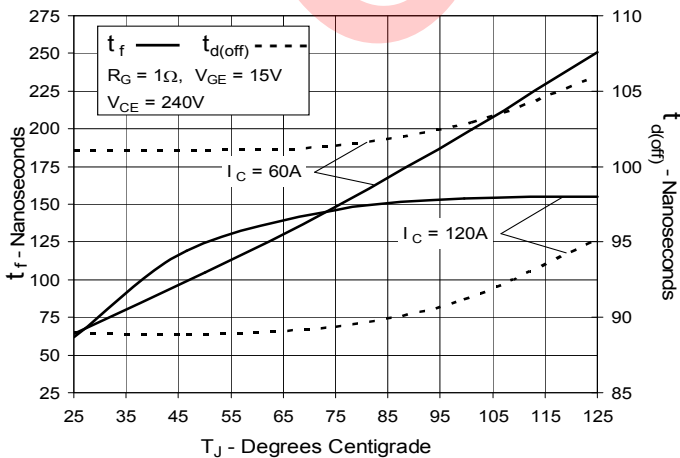
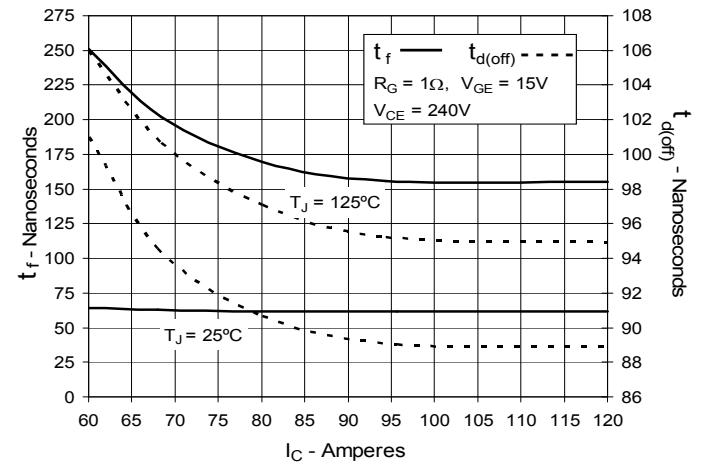

Fig. 11. Maximum Transient Thermal Impedance



IXYS reserves the right to change limits, test conditions, and dimensions.

Fig. 12. Resistive Turn-on Rise Time vs. Junction Temperature

Fig. 13. Resistive Turn-on Rise Time vs. Collector Current

Fig. 14. Resistive Turn-on Switching Times vs. Gate Resistance

Fig. 15. Resistive Turn-off Switching Times vs. Gate Resistance

Fig. 16. Resistive Turn-off Switching Times vs. Junction Temperature

Fig. 17. Resistive Turn-off Switching Times vs. Collector Current

Obsolete



Disclaimer Notice - Information furnished is believed to be accurate and reliable. However, users should independently evaluate the suitability of and test each product selected for their own applications. Littelfuse products are not designed for, and may not be used in, all applications. Read complete Disclaimer Notice at www.littelfuse.com/disclaimer-electronics.