

GenX3™ 600V IGBT w/ Diode

IXGH36N60B3D1

$V_{CES} = 600V$
 $I_{C110} = 36A$
 $V_{CE(sat)} \leq 1.8V$

Medium-Speed Low-V_{sat} PT IGBT
for 5 - 40kHz Switching

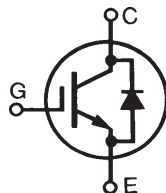

TO-247

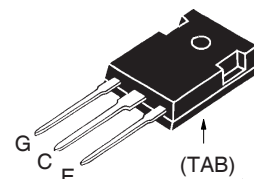

G = Gate C = Collector
 E = Emitter TAB = Collector

Symbol	Test Conditions	Maximum Ratings	
V_{CES}	$T_J = 25^\circ C$ to $150^\circ C$	600	V
V_{CGR}	$T_J = 25^\circ C$ to $150^\circ C$, $R_{GE} = 1M\Omega$	600	V
V_{GES}	Continuous	± 20	V
V_{GEM}	Transient	± 30	V
I_{C110}	$T_C = 110^\circ C$	36	A
I_{F110}	$T_C = 110^\circ C$	30	A
I_{CM}	$T_C = 25^\circ C$, 1ms	200	A
SSOA (RBSOA)	$V_{GE} = 15V$, $T_{VJ} = 125^\circ C$, $R_G = 5\Omega$ Clamped Inductive Load	$I_{CM} = 80$ $V_{CE} \leq V_{CES}$	A
P_C	$T_C = 25^\circ C$	250	W
T_J		-55 ... +150	$^\circ C$
T_{JM}		150	$^\circ C$
T_{stg}		-55 ... +150	$^\circ C$
T_L	1.6mm (0.062 in.) from Case for 10s	300	$^\circ C$
T_{SOLD}	Plastic Body for 10s	260	$^\circ C$
M_d	Mounting Torque	1.13/10	Nm/lb.in.
Weight		6	g

Features

- Optimized for Low Conduction and Switching Losses
- Square RBSOA
- Anti-Parallel Ultra Fast Diode
- International Standard Package

Advantages

- High Power Density
- Low Gate Drive Requirement

Applications

- Power Inverters
- UPS
- Motor Drives
- SMPS
- PFC Circuits
- Battery Chargers
- Welding Machines
- Lamp Ballasts

Symbol	Test Conditions ($T_J = 25^\circ C$ Unless Otherwise Specified)	Characteristic Values		
		Min.	Typ.	Max.
BV_{CES}	$I_C = 250\mu A$, $V_{GE} = 0V$	600		V
$V_{GE(th)}$	$I_C = 250\mu A$, $V_{CE} = V_{GE}$	3.0		5.0 V
I_{CES}	$V_{CE} = V_{CES}$, $V_{GE} = 0V$ $T_J = 125^\circ C$			300 μA 1.75 mA
I_{GES}	$V_{CE} = 0V$, $V_{GE} = \pm 20V$			± 100 nA
$V_{CE(sat)}$	$I_C = 30A$, $V_{GE} = 15V$, Note 1	1.5	1.8	V

Symbol	Test Conditions	Characteristic Values		
		Min.	Typ.	Max.
g_{fs}	$I_C = 30A, V_{CE} = 10V, \text{Note 1}$	28	42	S
C_{ies}	$V_{CE} = 25V, V_{GE} = 0V, f = 1MHz$		2280	pF
C_{oes}			120	pF
C_{res}			32	pF
Q_g	$I_C = 30A, V_{GE} = 15V, V_{CE} = 0.5 \cdot V_{CES}$		80	nC
Q_{ge}			12	nC
Q_{gc}			36	nC
$t_{d(on)}$	Inductive Load, $T_J = 25^\circ C$ $I_C = 30A, V_{GE} = 15V$ $V_{CE} = 400V, R_G = 5\Omega$		19	ns
t_{ri}			24	ns
E_{on}			0.54	mJ
$t_{d(off)}$			125	200 ns
t_{fi}			100	160 ns
E_{off}			0.8	1.5 mJ
$t_{d(on)}$	Inductive Load, $T_J = 125^\circ C$ $I_C = 30A, V_{GE} = 15V$ $V_{CE} = 400V, R_G = 5\Omega$		19	ns
t_{ri}			26	ns
E_{on}			0.9	mJ
$t_{d(off)}$			180	ns
t_{fi}			170	ns
E_{off}			1.5	mJ
R_{thJC}			0.50	$^\circ C/W$
R_{thCS}		0.21		$^\circ C/W$

TO-247 Outline (IXGH)

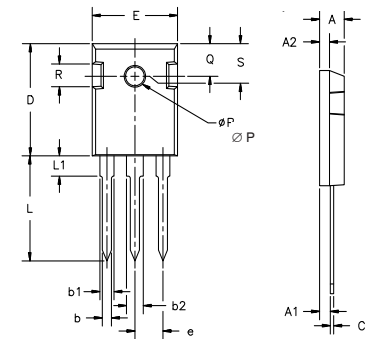

Dim.	Millimeter		Inches	
	Min.	Max.	Min.	Max.
A	4.7	5.3	.185	.209
A ₁	2.2	2.54	.087	.102
A ₂	2.2	2.6	.059	.098
b	1.0	1.4	.040	.055
b ₁	1.65	2.13	.065	.084
b ₂	2.87	3.12	.113	.123
C	.4	.8	.016	.031
D	20.80	21.46	.819	.845
E	15.75	16.26	.610	.640
e	5.20	5.72	0.205	0.225
L	19.81	20.32	.780	.800
L1		4.50		.177
∅P	3.55	3.65	.140	.144
Q	5.89	6.40	0.232	0.252
R	4.32	5.49	.170	.216
S	6.15	BSC	.242	BSC

Reverse Diode (FRED)

Symbol	Test Conditions	Characteristic Values		
		Min.	Typ.	Max.
V_F	$I_F = 30A, V_{GE} = 0V, \text{Note 1}$ $T_J = 150^\circ C$			2.8 V 1.7 V
I_{RM}	$I_F = 30A, V_{GE} = 0V, -di_F/dt = 100A/\mu s, T_J = 100^\circ C$ $V_R = 100V$		6	A
t_{rr}	$I_F = 1A, -di_F/dt = 100A/\mu s, V_R = 30V$ $T_J = 100^\circ C$		25 100	ns ns
R_{thJC}				0.9 $^\circ C/W$

Note 1. Pulse test, $t \leq 300\mu s$; duty cycle, $d \leq 2\%$.

IXYS Reserves the Right to Change Limits, Test Conditions, and Dimensions.

IXYS MOSFETs and IGBTs are covered by one or more of the following U.S. patents:

4,835,592	4,931,844	5,049,961	5,237,481	6,162,665	6,404,065 B1	6,683,344	6,727,585	7,005,734 B2	7,157,338B2
4,850,072	5,017,508	5,063,307	5,381,025	6,259,123 B1	6,534,343	6,710,405 B2	6,759,692	7,063,975 B2	
4,881,106	5,034,796	5,187,117	5,486,715	6,306,728 B1	6,583,505	6,710,463	6,771,478 B2	7,071,537	

Fig. 1. Output Characteristics @ 25°C

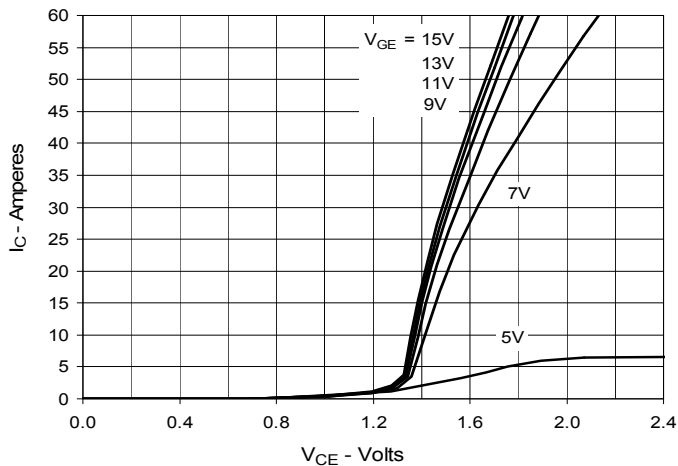

Fig. 2. Extended Output Characteristics @ 25°C

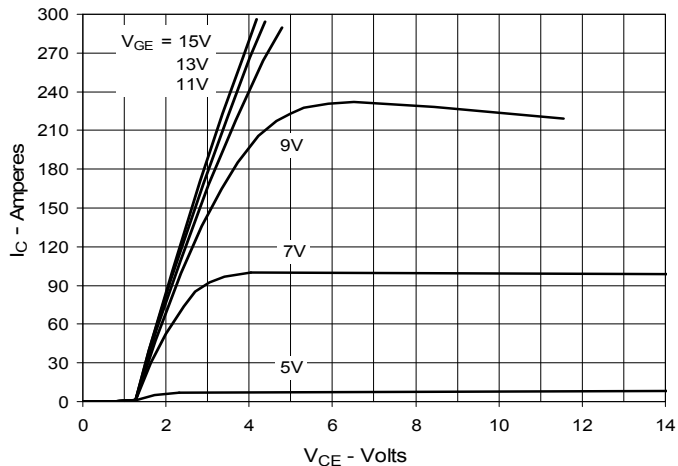

Fig. 3. Output Characteristics @ 125°C

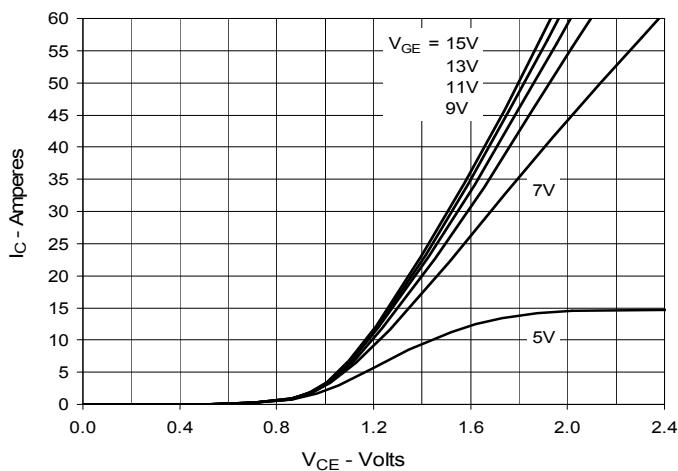

Fig. 4. Dependence of $V_{CE(sat)}$ on Junction Temperature

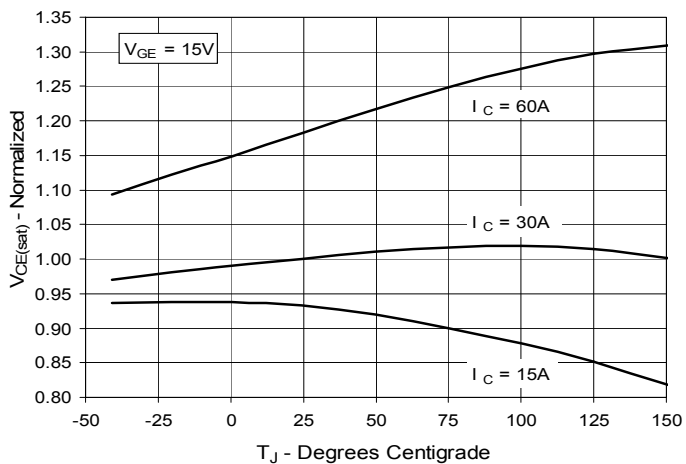

Fig. 5. Collector-to-Emitter Voltage vs. Gate-to-Emitter Voltage

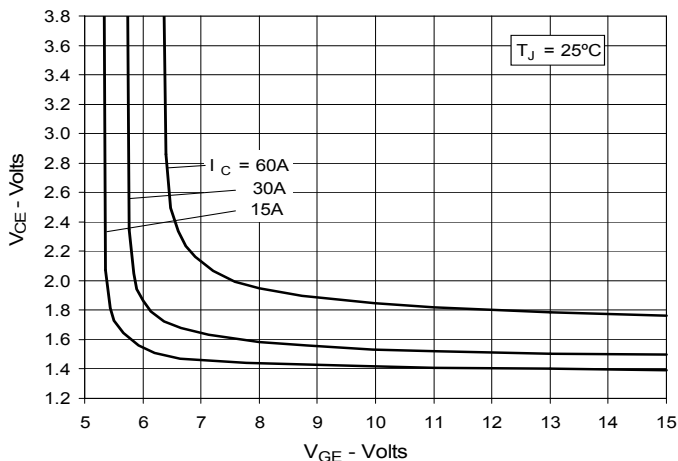

Fig. 6. Input Admittance

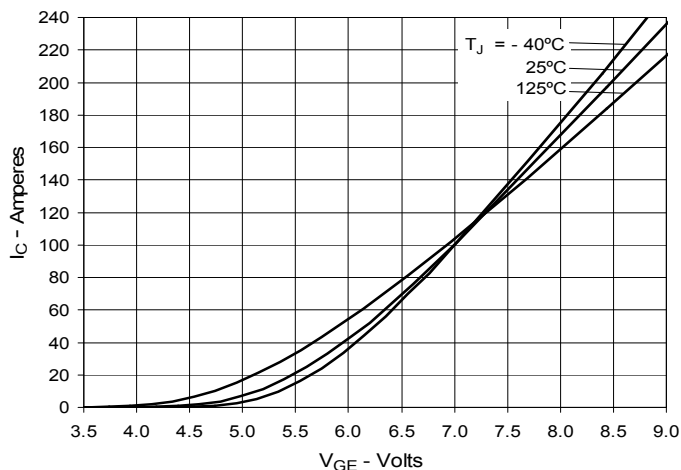

Fig. 7. Transconductance

Fig. 8. Gate Charge

Fig. 9. Capacitance

Fig. 10. Reverse-Bias Safe Operating Area

Fig. 11. Maximum Transient Thermal Impedance

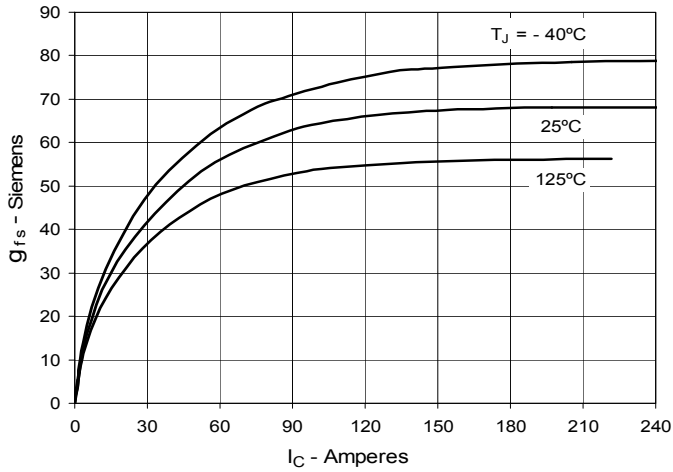
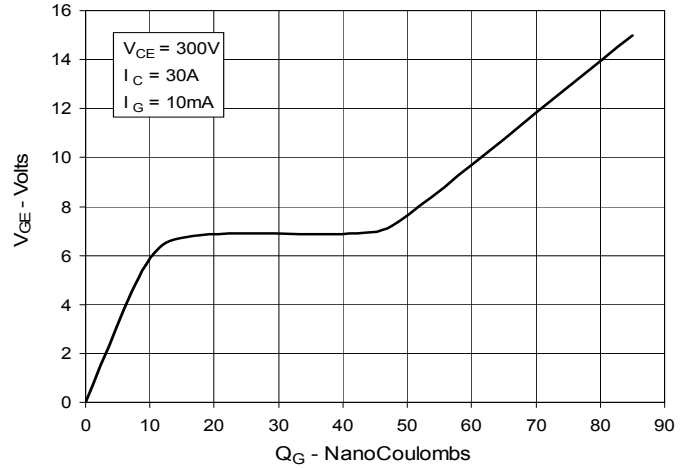
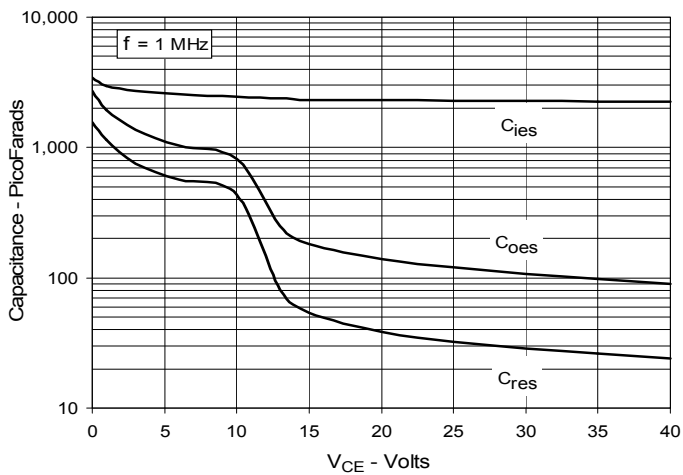
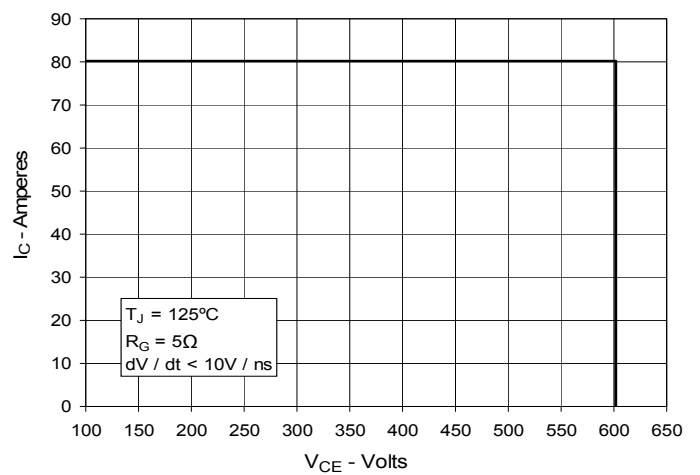
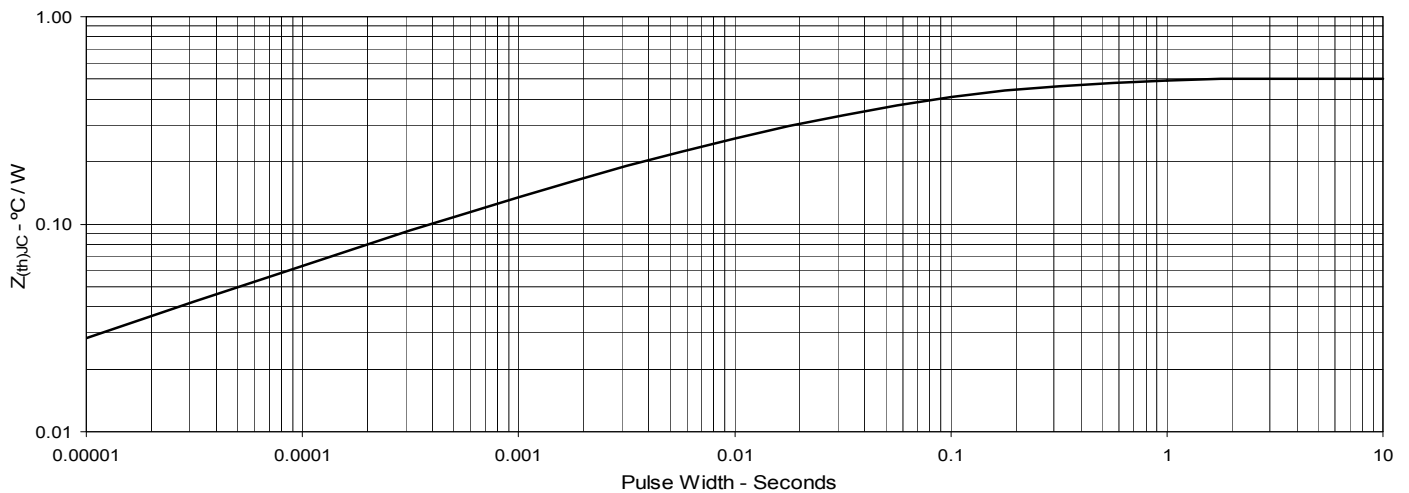
Fig. 12. Inductive Switching Energy Loss vs. Gate Resistance

Fig. 14. Inductive Switching Energy Loss vs. Junction Temperature

Fig. 16. Inductive Turn-off Switching Times vs. Collector Current

Fig. 13. Inductive Switching Energy Loss vs. Collector Current

Fig. 15. Inductive Turn-off Switching Times vs. Gate Resistance

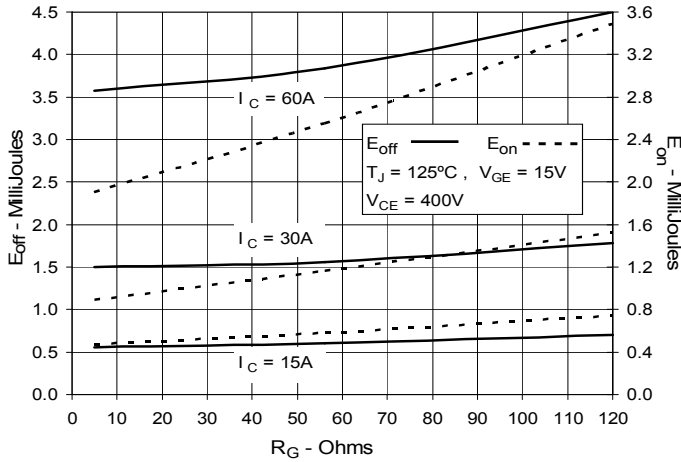
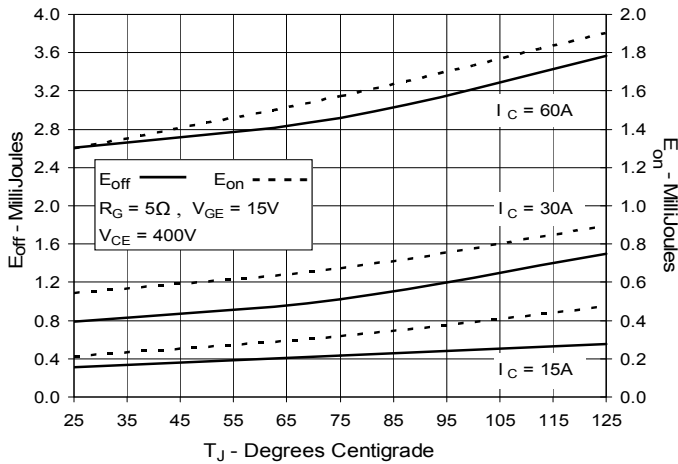
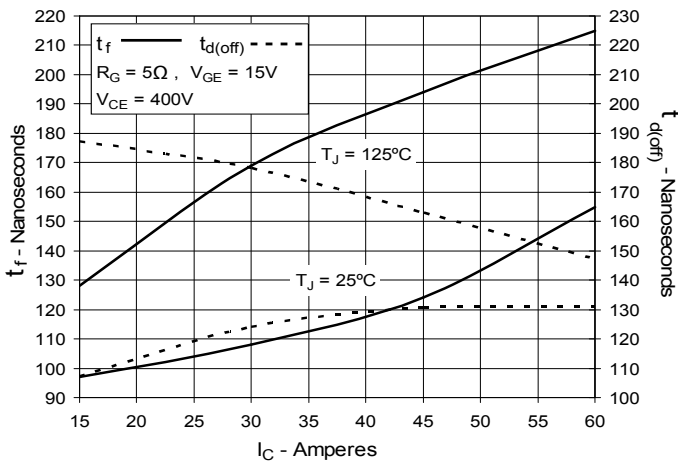
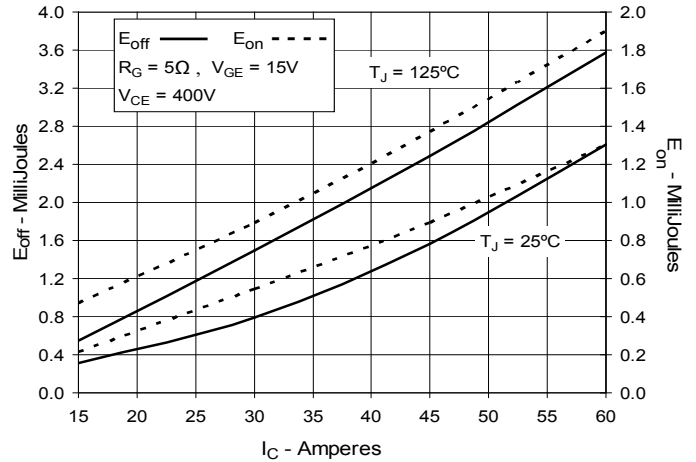
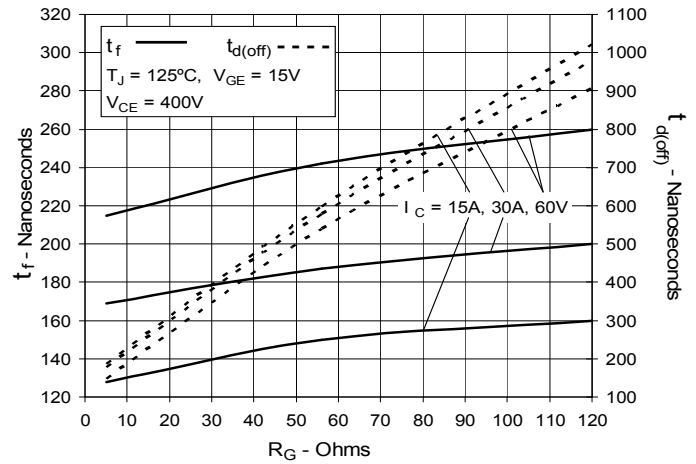
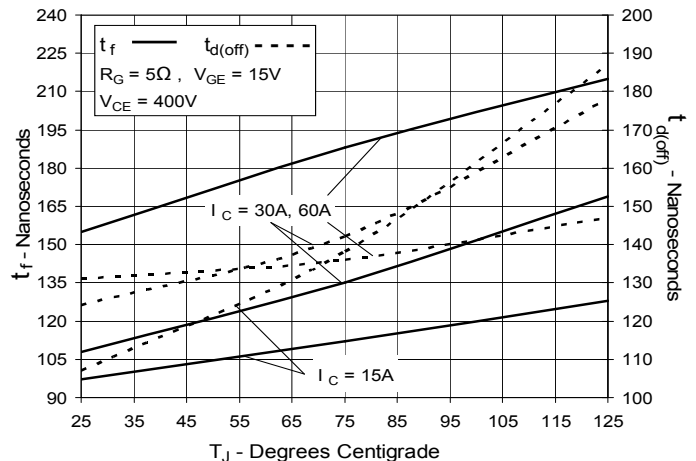
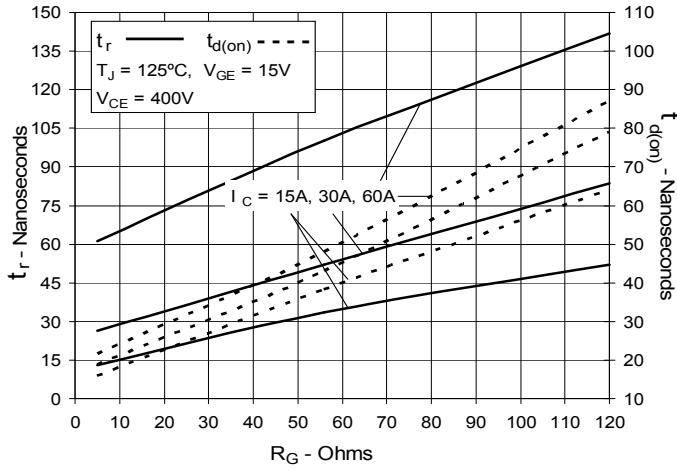
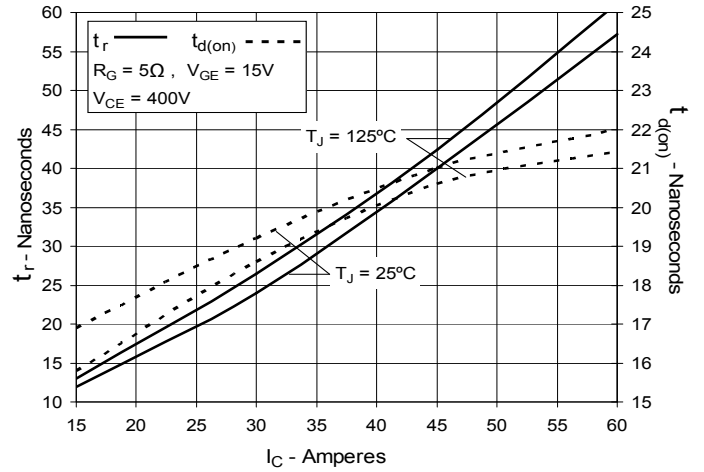
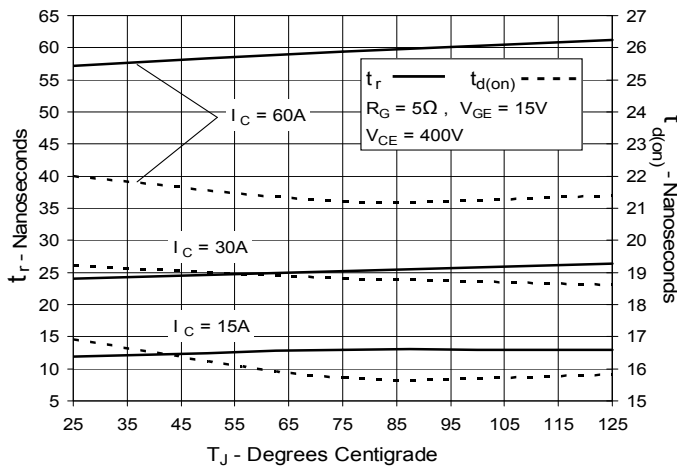
Fig. 17. Inductive Turn-off Switching Times vs. Junction Temperature

Fig. 18. Inductive Turn-on Switching Times vs. Gate Resistance

Fig. 19. Inductive Turn-on Switching Times vs. Collector Current

Fig. 20. Inductive Turn-on Switching Times vs. Junction Temperature

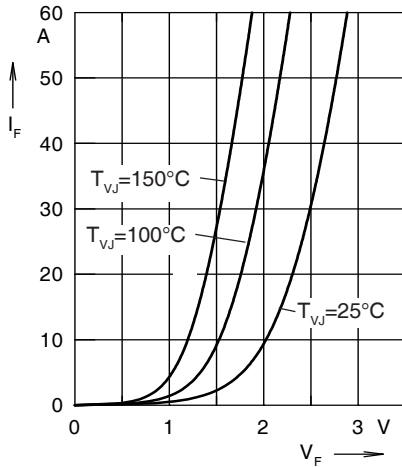

Fig. 21. Forward current I_F versus V_F

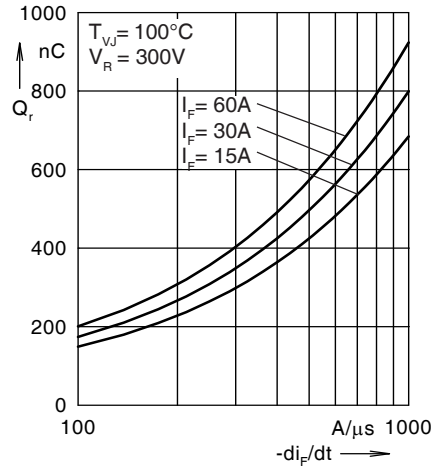

Fig. 22. Reverse recovery charge Q_r versus $-di_F/dt$

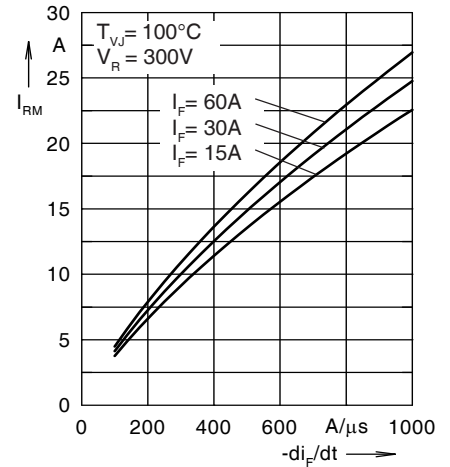

Fig. 23. Peak reverse current I_{RM} versus $-di_F/dt$

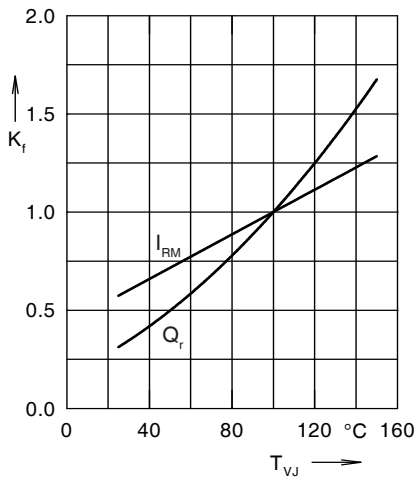

Fig. 24. Dynamic parameters Q_r , I_{RM} versus T_{VJ}

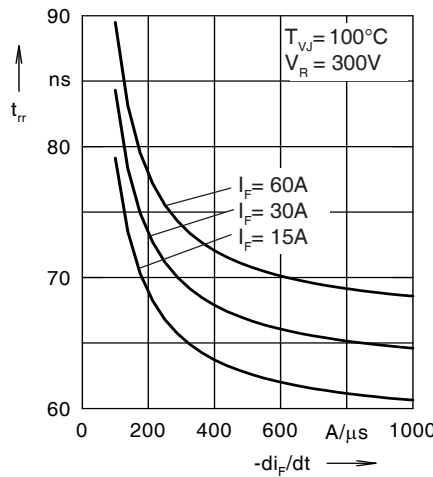

Fig. 25. Recovery time t_{tr} versus $-di_F/dt$

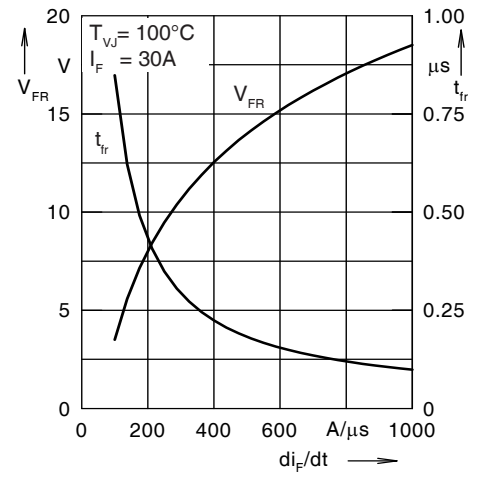

Fig. 26. Peak forward voltage V_{FR} and t_{tr} versus di_F/dt

Constants for Z_{thJC} calculation:

i	R_{thi} (K/W)	t_i (s)
1	0.502	0.0052
2	0.193	0.0003
3	0.205	0.0162

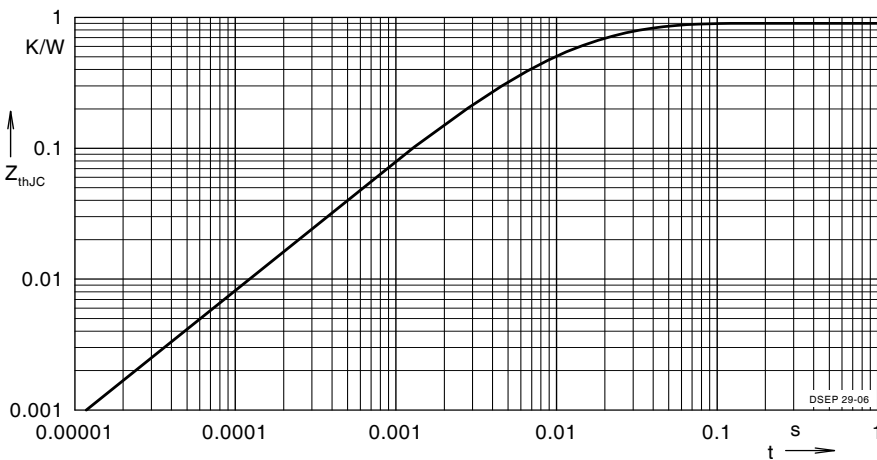

Fig. 27. Transient thermal resistance junction to case



Disclaimer Notice - Information furnished is believed to be accurate and reliable. However, users should independently evaluate the suitability of and test each product selected for their own applications. Littelfuse products are not designed for, and may not be used in, all applications. Read complete Disclaimer Notice at www.littelfuse.com/disclaimer-electronics.