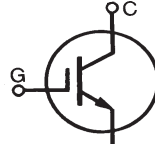
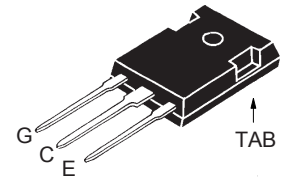

GenX3™ 1200V IGBT
IXGH40N120C3
**High speed PT IGBTs
for 20 - 50 kHz switching**

$$\begin{aligned}
 V_{CES} &= 1200V \\
 I_{C110} &= 40A \\
 V_{CE(sat)} &\leq 4.4V \\
 t_{fi(typ)} &= 57ns
 \end{aligned}$$

Symbol	Test Conditions	Maximum Ratings	
V_{CES}	$T_J = 25^\circ\text{C}$ to 150°C	1200	V
V_{CGR}	$T_J = 25^\circ\text{C}$ to 150°C , $R_{GE} = 1\text{M}\Omega$	1200	V
V_{GES}	Continuous	± 20	V
V_{GEM}	Transient	± 30	V
I_{C25}	$T_C = 25^\circ\text{C}$ (limited by leads)	75	A
I_{C110}	$T_C = 110^\circ\text{C}$	40	A
I_{CM}	$T_C = 25^\circ\text{C}$, 1ms	200	A
I_A	$T_C = 25^\circ\text{C}$	30	A
E_{AS}	$T_C = 25^\circ\text{C}$	500	mJ
SSOA (RBSOA)	$V_{GE} = 15\text{V}$, $T_J = 125^\circ\text{C}$, $R_G = 3\Omega$ Clamped inductive load @ $V_{CE} \leq 1200\text{V}$	$I_{CM} = 80$	A
P_C	$T_C = 25^\circ\text{C}$	380	W
T_J		-55 ... +150	$^\circ\text{C}$
T_{JM}		150	$^\circ\text{C}$
T_{stg}		-55 ... +150	$^\circ\text{C}$
M_d	Mounting torque	1.13 / 10	Nm/lb.in.
T_L	Maximum lead temperature for soldering	300	$^\circ\text{C}$
T_{SOLD}	1.6mm (0.062 in.) from case for 10s	260	$^\circ\text{C}$
Weight		6	g

TO-247 (IXGH)

G = Gate C = Collector
E = Emitter TAB = Collector

Features

- International standard packages: JEDEC TO-247AD
- IGBT and anti-parallel FRED in one package
- MOS Gate turn-on - drive simplicity

Applications

- AC motor speed control
- DC servo and robot drives
- DC choppers
- Uninterruptible power supplies (UPS)
- Switch-mode and resonant-mode power supplies

Symbol	Test Conditions ($T_J = 25^\circ\text{C}$, unless otherwise specified)	Characteristic Values		
		Min.	Typ.	Max.
BV_{CES}	$I_C = 250\mu\text{A}$, $V_{GE} = 0\text{V}$	1200		V
$V_{GE(th)}$	$I_C = 250\mu\text{A}$, $V_{CE} = V_{GE}$	3.0		5.0 V
I_{CES}	$V_{CE} = V_{CES}$			75 μA
	$V_{GE} = 0\text{V}$ $T_J = 125^\circ\text{C}$			1.5 mA
I_{GES}	$V_{CE} = 0\text{V}$, $V_{GE} = \pm 20\text{V}$			± 100 nA
$V_{CE(sat)}$	$I_C = 30\text{A}$, $V_{GE} = 15\text{V}$, Note 1			4.4 V
	$T_J = 125^\circ\text{C}$	2.7		V

Symbol	Test Conditions ($T_J = 25^\circ\text{C}$, unless otherwise specified)	Characteristic Values		
		Min.	Typ.	Max.
g_{fs}	$I_C = 30\text{A}, V_{CE} = 10\text{V}$, Note 1	18	30	S
C_{ies}	$V_{CE} = 25\text{V}, V_{GE} = 0\text{V}, f = 1\text{MHz}$		2930	pF
C_{oes}			225	pF
C_{res}			93	pF
Q_g	$I_C = 40\text{A}, V_{GE} = 15\text{V}, V_{CE} = 0.5 \cdot V_{CES}$		142	nC
Q_{ge}			19	nC
Q_{gc}			62	nC
$t_{d(on)}$	Inductive load, $T_J = 25^\circ\text{C}$ $I_C = 30\text{A}, V_{GE} = 15\text{V}$ $V_{CE} = 600\text{V}, R_G = 3\Omega$ Note 1		17	ns
t_{ri}			33	ns
E_{on}			1.8	mJ
$t_{d(off)}$			130	ns
t_{fi}			57	ns
E_{off}		0.55	1.0	mJ
$t_{d(on)}$	Inductive load, $T_J = 125^\circ\text{C}$ $I_C = 30\text{A}, V_{GE} = 15\text{V}$ $V_{CE} = 600\text{V}, R_G = 3\Omega$ Note 1		17	ns
t_{ri}			35	ns
E_{on}			3.5	mJ
$t_{d(off)}$			177	ns
t_{fi}			298	ns
E_{off}		1.6	mJ	
R_{thJC}				0.33 $^\circ\text{C/W}$
R_{thCK}		0.21		$^\circ\text{C/W}$

TO-247 (IXGH) Outline

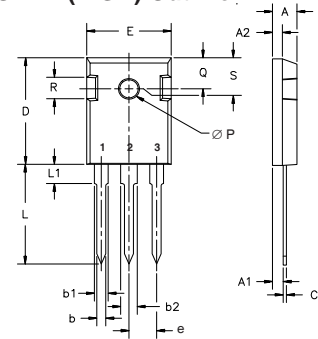

Terminals: 1 - Gate 2 - Drain
3 - Source Tab - Drain

Dim.	Millimeter		Inches	
	Min.	Max.	Min.	Max.
A	4.7	5.3	.185	.209
A ₁	2.2	2.54	.087	.102
A ₂	2.2	2.6	.059	.098
b	1.0	1.4	.040	.055
b ₁	1.65	2.13	.065	.084
b ₂	2.87	3.12	.113	.123
C	.4	.8	.016	.031
D	20.80	21.46	.819	.845
E	15.75	16.26	.610	.640
e	5.20	5.72	0.205	0.225
L	19.81	20.32	.780	.800
L1		4.50		.177
∅P	3.55	3.65	.140	.144
Q	5.89	6.40	0.232	0.252
R	4.32	5.49	.170	.216
S	6.15	BSC	242	BSC

Notes: 1. Pulse test, $t \leq 300\mu\text{s}$; duty cycle, $d \leq 2\%$.

PRELIMINARY TECHNICAL INFORMATION

The product presented herein is under development. The Technical Specifications offered are derived from data gathered during objective characterizations of preliminary engineering lots; but also may yet contain some information supplied during a pre-production design evaluation. IXYS reserves the right to change limits, test conditions, and dimensions without notice.

IXYS reserves the right to change limits, test conditions, and dimensions.

IXYS MOSFETs and IGBTs are covered by one or more of the following U.S. patents:	4,835,592	4,931,844	5,049,961	5,237,481	6,162,665	6,404,065 B1	6,683,344	6,727,585	7,005,734 B2	7,157,338B2
	4,850,072	5,017,508	5,063,307	5,381,025	6,259,123 B1	6,534,343	6,710,405 B2	6,759,692	7,063,975 B2	
	4,881,106	5,034,796	5,187,117	5,486,715	6,306,728 B1	6,583,505	6,710,463	6,771,478 B2	7,071,537	

Fig. 1. Output Characteristics @ 25°C

Fig. 2. Extended Output Characteristics @ 25°C

Fig. 3. Output Characteristics @ 125°C

Fig. 4. Dependence of $V_{CE(sat)}$ on Junction Temperature

Fig. 5. Collector-to-Emitter Voltage vs. Gate-to-Emitter Voltage

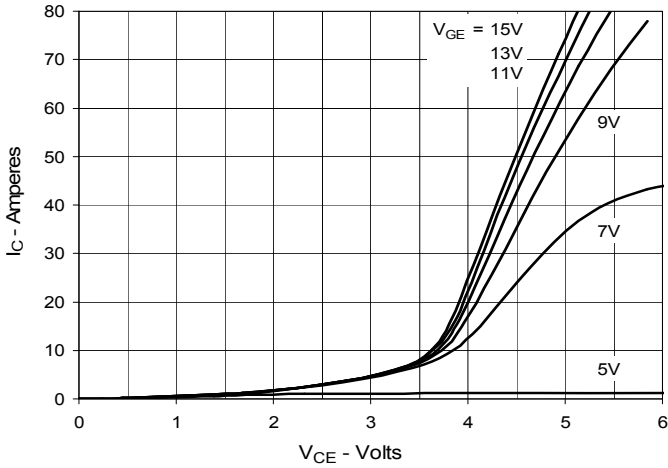
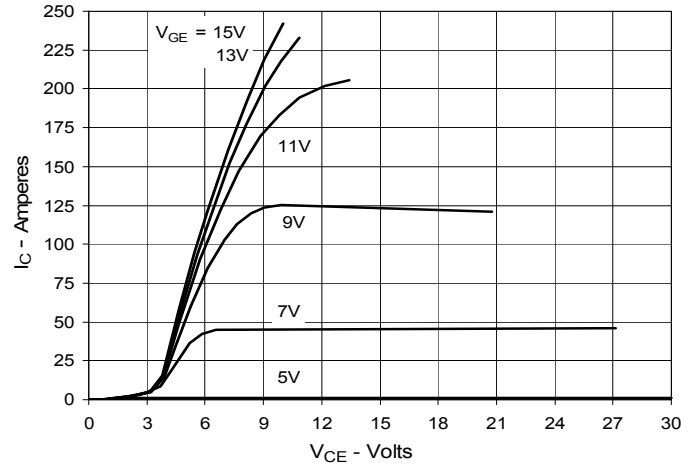
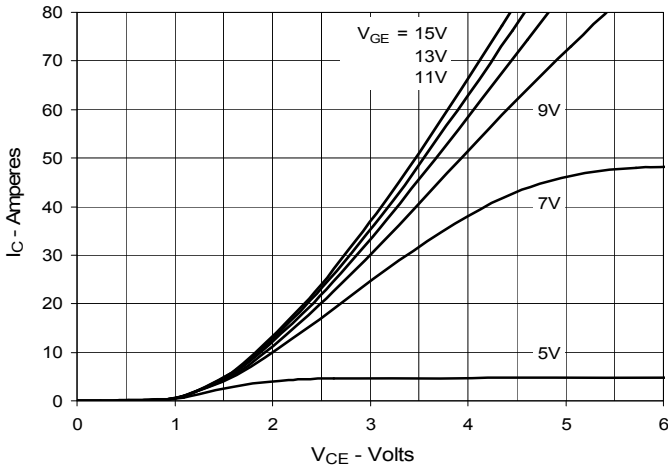
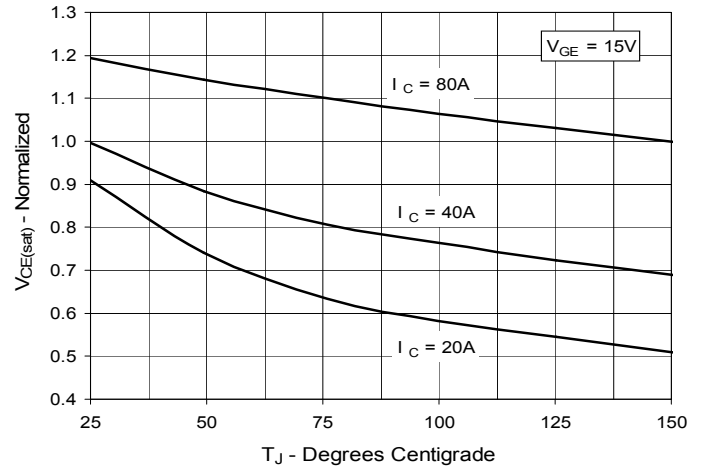
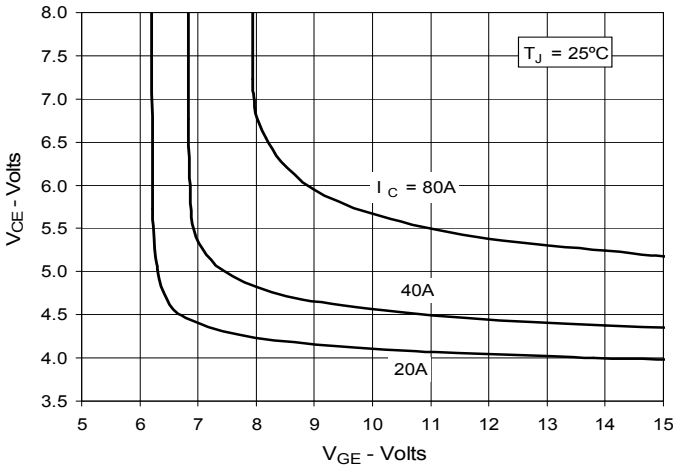
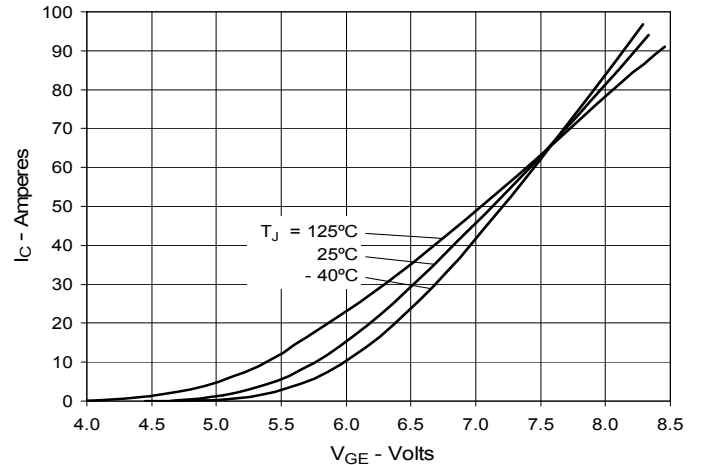
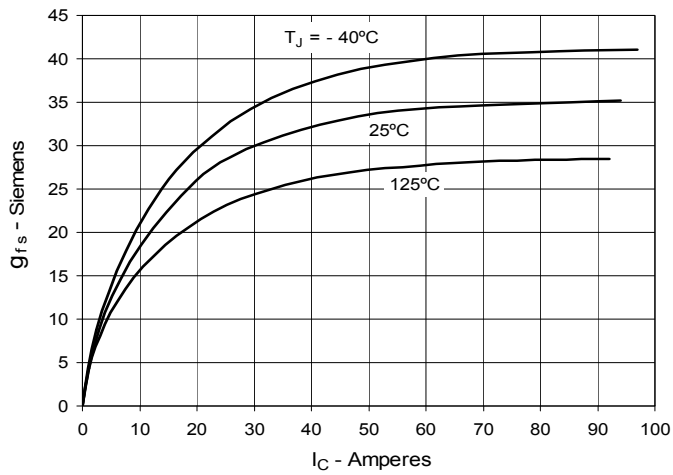
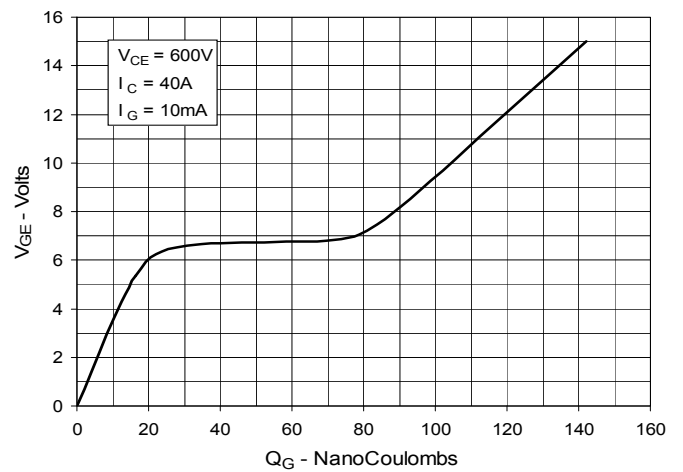
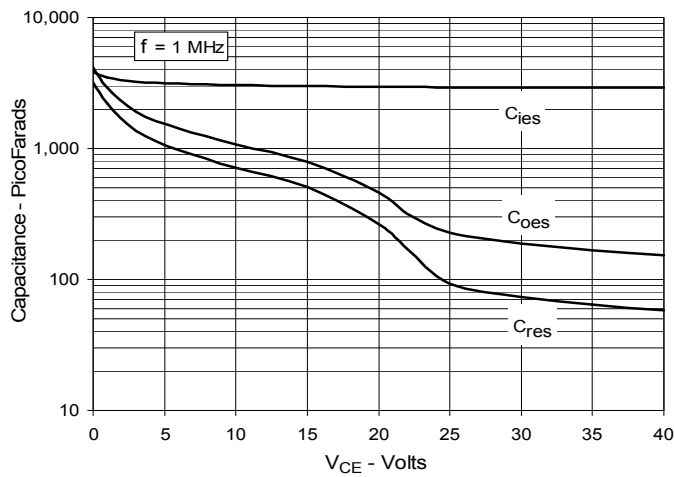
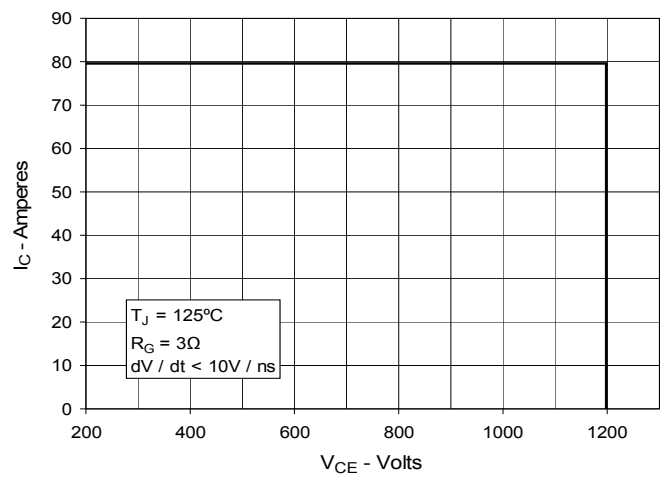
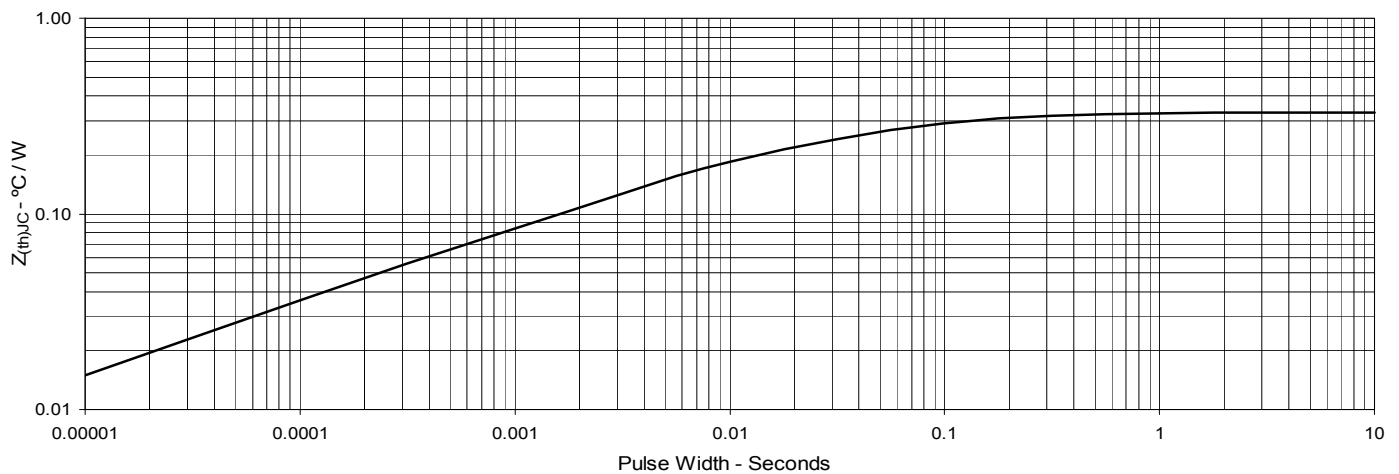
Fig. 6. Input Admittance

Fig. 7. Transconductance

Fig. 8. Gate Charge

Fig. 9. Capacitance

Fig. 10. Reverse-Bias Safe Operating Area

Fig. 11. Maximum Transient Thermal Impedance

IXYS reserves the right to change limits, test conditions, and dimensions.

Fig. 12. Inductive Switching Energy Loss vs. Gate Resistance

Fig. 13. Inductive Switching Energy Loss vs. Collector Current

Fig. 14. Inductive Switching Energy Loss vs. Junction Temperature

Fig. 15. Inductive Turn-off Switching Times vs. Gate Resistance

Fig. 16. Inductive Turn-off Switching Times vs. Collector Current

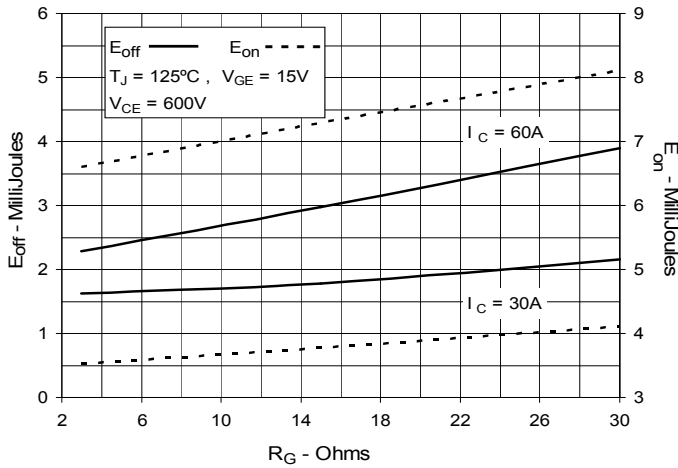
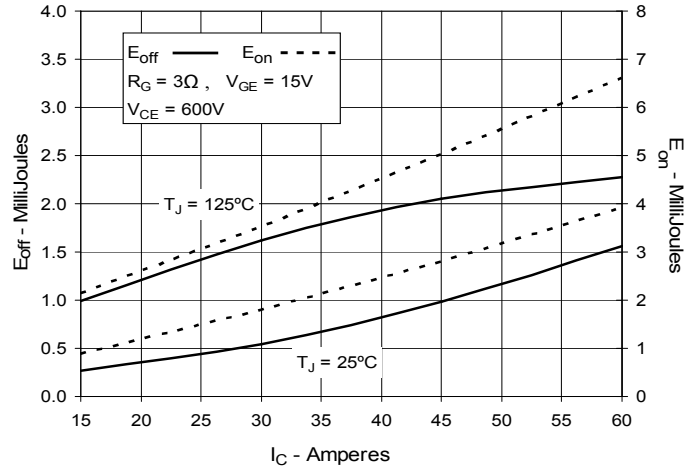
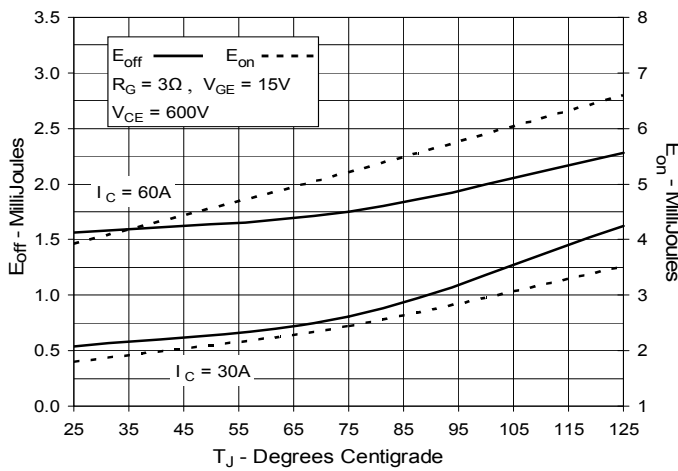
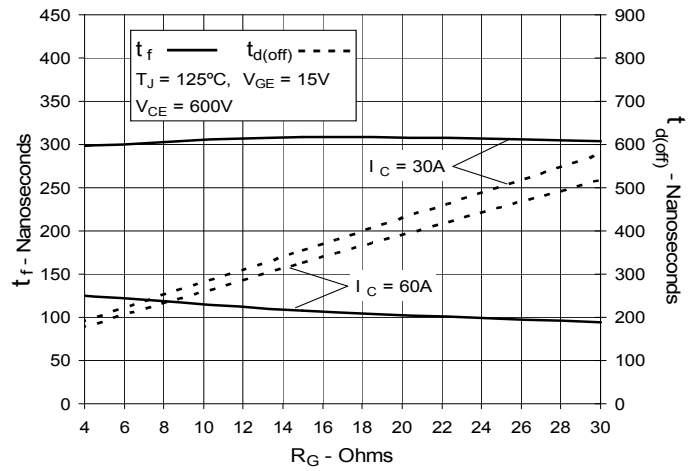
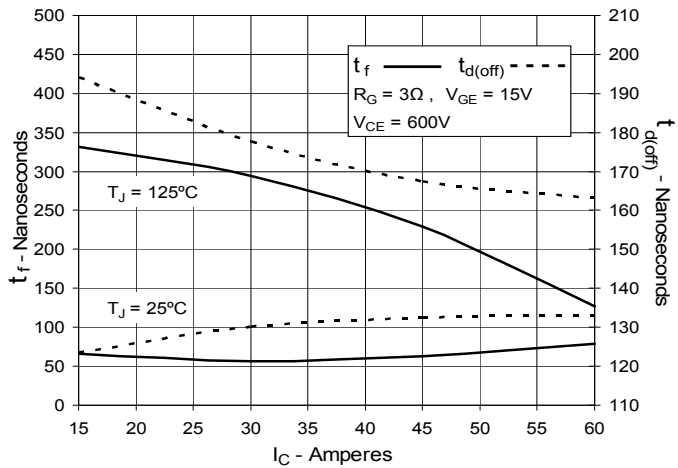
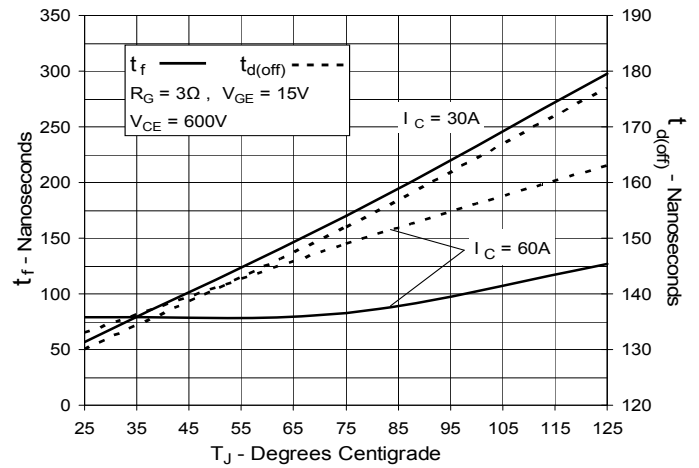
Fig. 17. Inductive Turn-off Switching Times vs. Junction Temperature

Fig. 18. Inductive Turn-on Switching Times vs. Gate Resistance

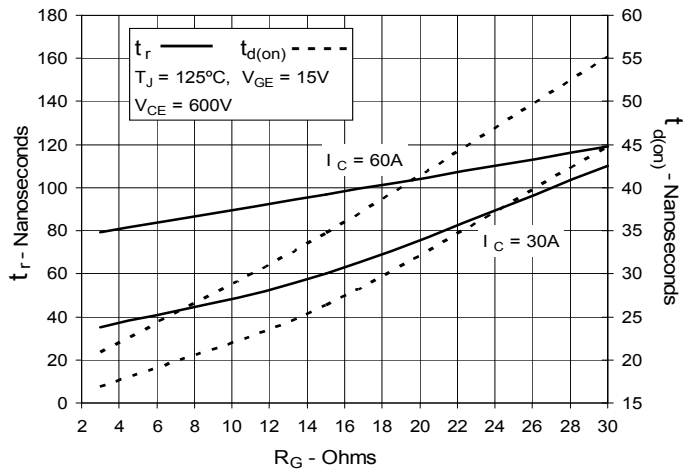

Fig. 19. Inductive Turn-on Switching Times vs. Collector Current

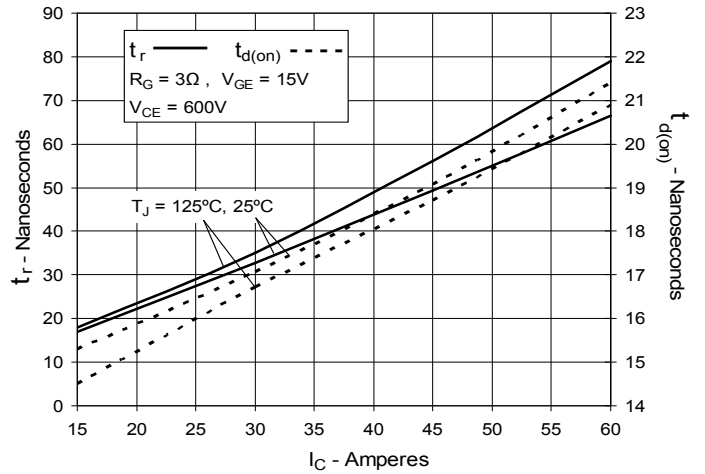
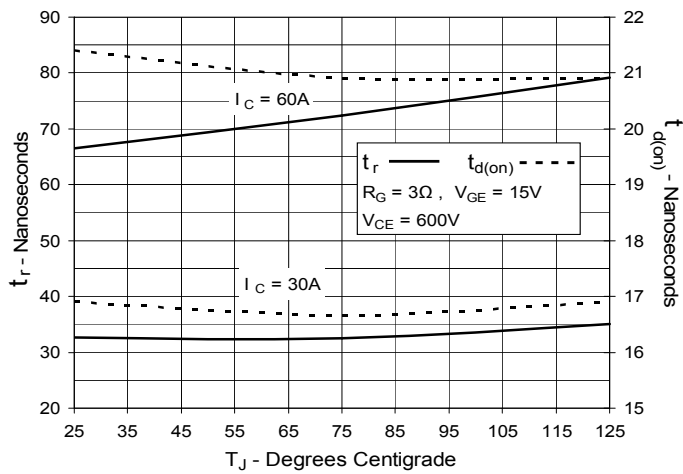

Fig. 20. Inductive Turn-on Switching Times vs. Junction Temperature





Disclaimer Notice - Information furnished is believed to be accurate and reliable. However, users should independently evaluate the suitability of and test each product selected for their own applications. Littelfuse products are not designed for, and may not be used in, all applications. Read complete Disclaimer Notice at www.littelfuse.com/disclaimer-electronics.