

GenX3™ 600V IGBT w/Diode

IXGH48N60A3D1

$V_{CES} = 600V$
 $I_{C110} = 48A$
 $V_{CE(sat)} \leq 1.35V$

Ultra Low V_{sat} PT IGBT for
up to 5kHz switching

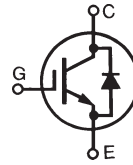

TO-247 AD

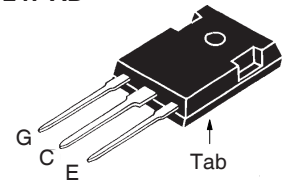

G = Gate C = Collector
 E = Emitter Tab = Collector

Symbol	Test Conditions	Maximum Ratings	
V_{CES}	$T_C = 25^\circ C$ to $150^\circ C$	600	V
V_{CGR}	$T_J = 25^\circ C$ to $150^\circ C$, $R_{GE} = 1M\Omega$	600	V
V_{GES}	Continuous	± 20	V
V_{GEM}	Transient	± 30	V
I_{C110}	$T_C = 110^\circ C$	48	A
I_{CM}	$T_C = 25^\circ C$, 1ms	300	A
SSOA (RBSOA)	$V_{GE} = 15V$, $T_{VJ} = 125^\circ C$, $R_G = 5\Omega$ Clamped inductive load	$I_{CM} = 96$ @ $\leq V_{CES}$	A
P_C	$T_C = 25^\circ C$	300	W
T_J		-55 ... +150	$^\circ C$
T_{JM}		150	$^\circ C$
T_{stg}		-55 ... +150	$^\circ C$
T_L	1.6mm (0.062in.) from case for 10s	300	$^\circ C$
T_{SOLD}	Plastic body for 10 seconds	260	$^\circ C$
M_d	Mounting torque	1.13/10	Nm/lb.in.
Weight		6	g

Features

- Optimized for Low Conduction Losses
- Square RBSOA
- Anti-Parallel Ultra Fast Diode
- High Current Handling Capability
- International Standard Package

Advantages

- High Power Density
- Low Gate Drive Requirement

Applications

- Power Inverters
- UPS
- Motor Drives
- SMPS
- PFC Circuits
- Battery Chargers
- Welding Machines
- Lamp Ballasts
- Inrush Current Protection Circuits

Symbol	Test Conditions ($T_J = 25^\circ C$ unless otherwise specified)	Characteristic Values		
		Min.	Typ.	Max.
$V_{GE(th)}$	$I_C = 250\mu A$, $V_{CE} = V_{GE}$	3.0		5.5 V
I_{CES}	$V_{CE} = 0.8 \cdot V_{CES}$, $V_{GE} = 0V$ $T_J = 125^\circ C$			300 μA 1.75 mA
I_{GES}	$V_{CE} = 0V$, $V_{GE} = \pm 20V$			± 100 nA
$V_{CE(sat)}$	$I_C = 32A$, $V_{GE} = 15V$, Note 1		1.18	1.35 V

Symbol Test Conditions ($T_J = 25^\circ\text{C}$ unless otherwise specified)		Characteristic Values		
		Min.	Typ.	Max.
g_{fs}	$I_C = 32\text{A}, V_{CE} = 10\text{V}, \text{Note 1}$	30	48	S
C_{ies}	$V_{CE} = 25\text{V}, V_{GE} = 0\text{V}, f = 1\text{MHz}$		3190	pF
C_{oes}			175	pF
C_{res}			43	pF
Q_g	$I_C = 32\text{A}, V_{GE} = 15\text{V}, V_{CE} = 0.5 \cdot V_{CES}$		110	nC
Q_{ge}			21	nC
Q_{gc}			42	nC
$t_{d(on)}$	Inductive Load, $T_J = 25^\circ\text{C}$ $I_C = 32\text{A}, V_{GE} = 15\text{V}$ $V_{CE} = 480\text{V}, R_G = 5\Omega$ Note 2		25	ns
t_{ri}			30	ns
E_{on}			0.95	mJ
$t_{d(off)}$			334	ns
t_{fi}			224	ns
E_{off}			2.9	mJ
$t_{d(on)}$	Inductive Load, $T_J = 125^\circ\text{C}$ $I_C = 32\text{A}, V_{GE} = 15\text{V}$ $V_{CE} = 480\text{V}, R_G = 5\Omega$ Note 2		24	ns
t_{ri}			30	ns
E_{on}			1.97	mJ
$t_{d(off)}$			545	ns
t_{fi}			380	ns
E_{off}			5.6	mJ
R_{thJC}			0.42	$^\circ\text{C/W}$
R_{thCS}		0.21		$^\circ\text{C/W}$

TO-247 (IXGH) Outline

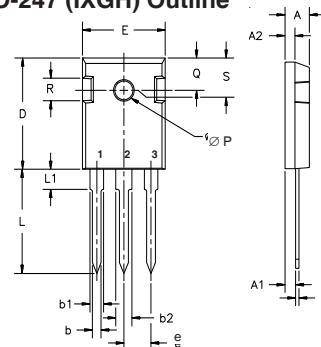

Terminals: 1 - Gate 2 - Collector
3 - Emitter

Dim.	Millimeter		Inches	
	Min.	Max.	Min.	Max.
A	4.7	5.3	.185	.209
A ₁	2.2	2.54	.087	.102
A ₂	2.2	2.6	.059	.098
b	1.0	1.4	.040	.055
b ₁	1.65	2.13	.065	.084
b ₂	2.87	3.12	.113	.123
C	.4	.8	.016	.031
D	20.80	21.46	.819	.845
E	15.75	16.26	.610	.640
e	5.20	5.72	0.205	0.225
L	19.81	20.32	.780	.800
L1		4.50		.177
∅P	3.55	3.65	.140	.144
Q	5.89	6.40	0.232	0.252
R	4.32	5.49	.170	.216
S	6.15	BSC	.242	BSC

Reverse Diode (FRED)

Symbol Test Conditions ($T_J = 25^\circ\text{C}$, Unless Otherwise Specified)		Characteristic Value		
		Min.	Typ.	Max.
V_F	$I_F = 30\text{A}, V_{GE} = 0\text{V}, \text{Note 1}$			3.0 V
			1.6	V
I_{RM}	$I_F = 30\text{A}, V_{GE} = 0\text{V}, -di_F/dt = 100\text{A}/\mu\text{s}, V_R = 300\text{V}$			4 A
t_{rr}	$I_F = 1\text{A}, V_R = 30\text{V}, -di_F/dt = 100\text{A}/\mu\text{s}$		100	ns
			25	ns
R_{thJC}				0.9 $^\circ\text{C/W}$

Notes:

1. Pulse test, $t \leq 300\mu\text{s}$, duty cycle, $d \leq 2\%$.
2. Switching times & energy losses may increase for higher $V_{CE}(\text{clamp})$, T_J or R_G .

IXYS Reserves the Right to Change Limits, Test Conditions and Dimensions.

IXYS MOSFETs and IGBTs are covered by one or more of the following U.S. patents:	4,835,592	4,931,844	5,049,961	5,237,481	6,162,665	6,404,065 B1	6,683,344	6,727,585	7,005,734 B2	7,157,338B2
	4,850,072	5,017,508	5,063,307	5,381,025	6,259,123 B1	6,534,343	6,710,405 B2	6,759,692	7,063,975 B2	
	4,881,106	5,034,796	5,187,117	5,486,715	6,306,728 B1	6,583,505	6,710,463	6,771,478 B2	7,071,537	

Fig. 1. Output Characteristics @ $T_J = 25^\circ\text{C}$

Fig. 2. Extended Output Characteristics @ $T_J = 25^\circ\text{C}$

Fig. 3. Output Characteristics @ $T_J = 125^\circ\text{C}$

Fig. 4. Dependence of $V_{CE(sat)}$ on Junction Temperature

Fig. 5. Collector-to-Emitter Voltage vs. Gate-to-Emitter Voltage

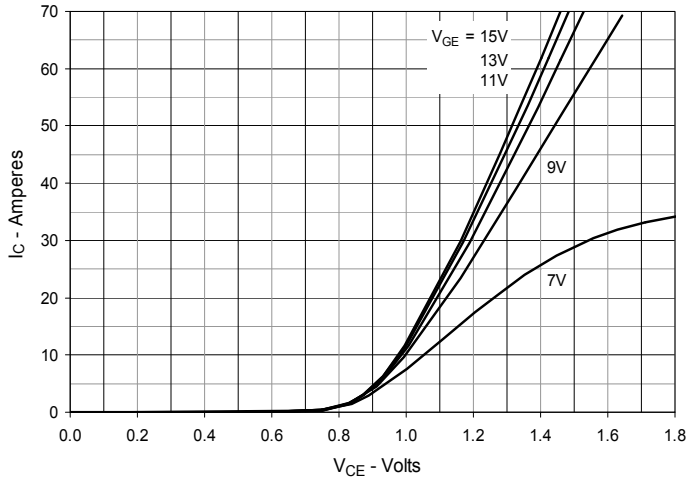
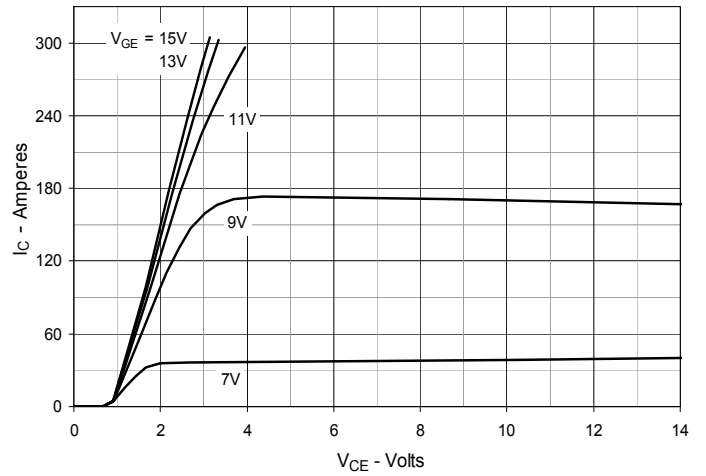
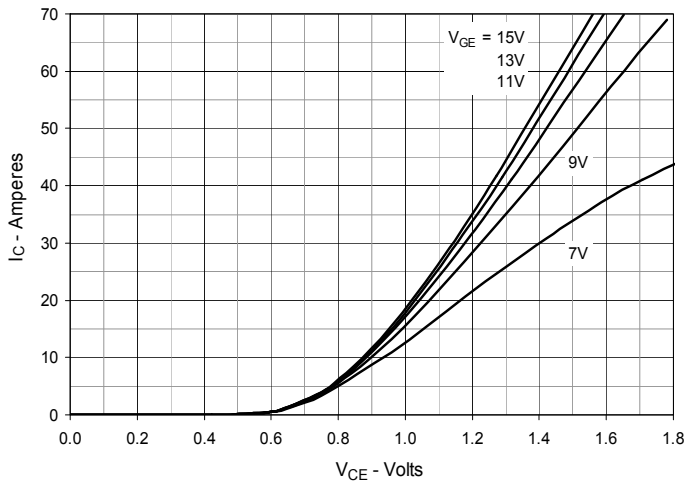
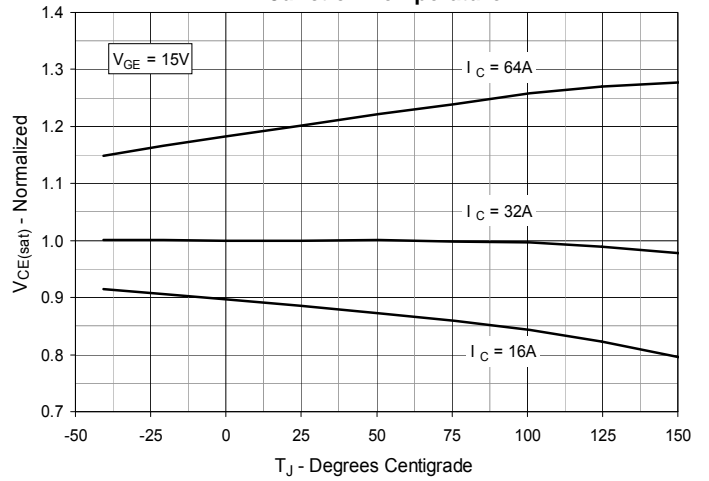
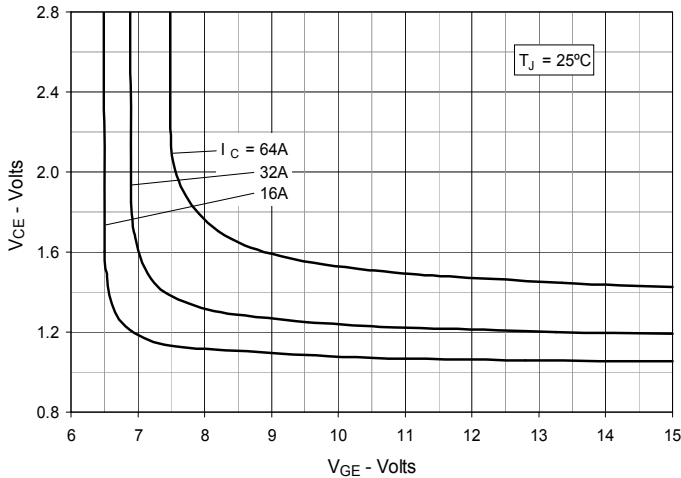
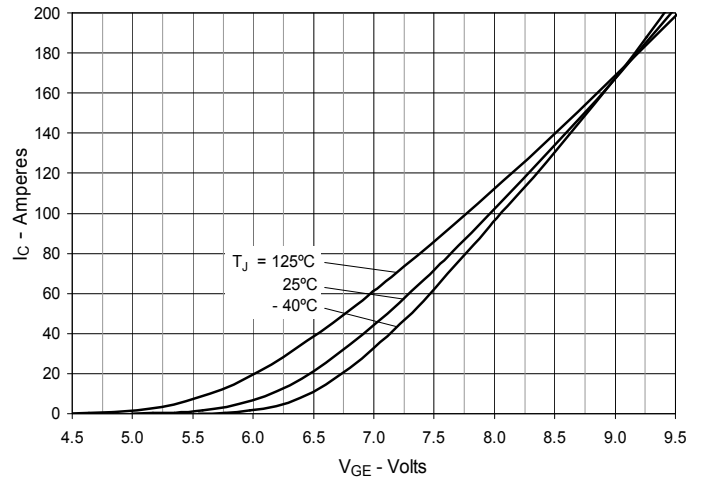
Fig. 6. Input Admittance

Fig. 7. Transconductance

Fig. 8. Gate Charge

Fig. 9. Capacitance

Fig. 10. Reverse-Bias Safe Operating Area

Fig. 11. Maximum Transient Thermal Impedance

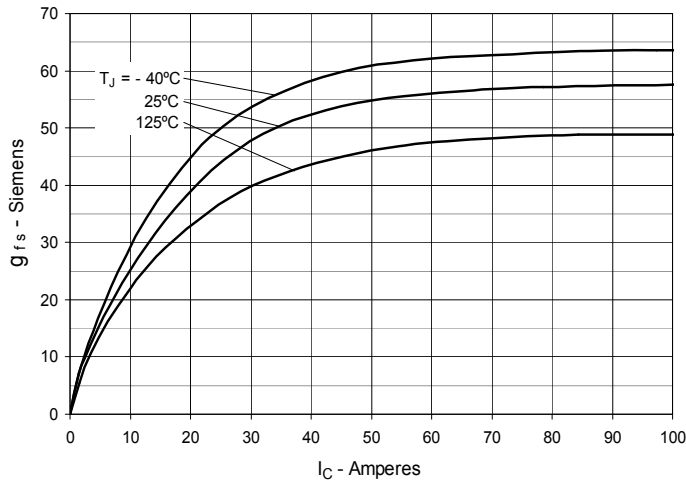
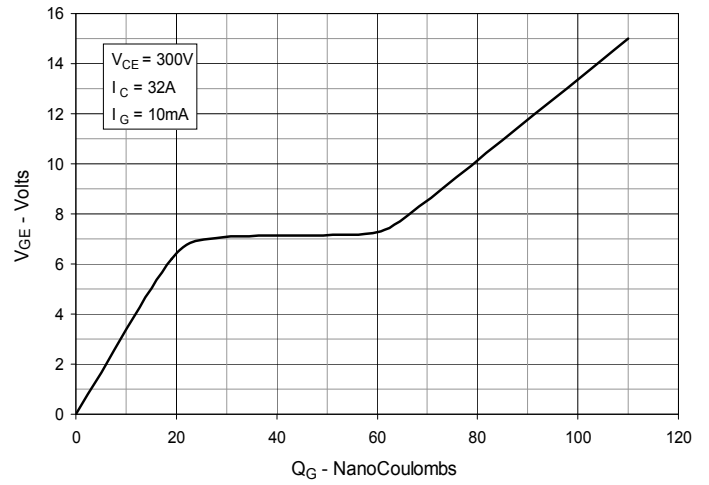
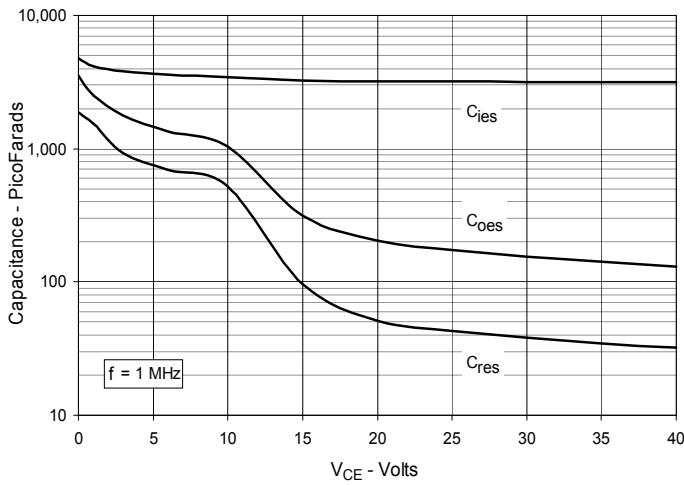
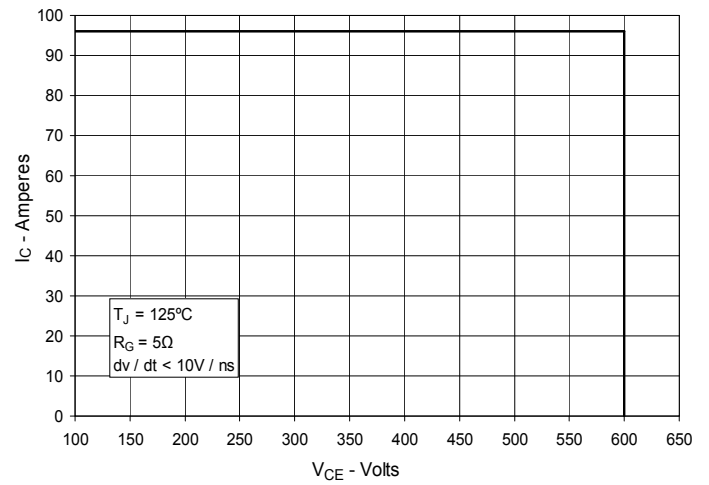
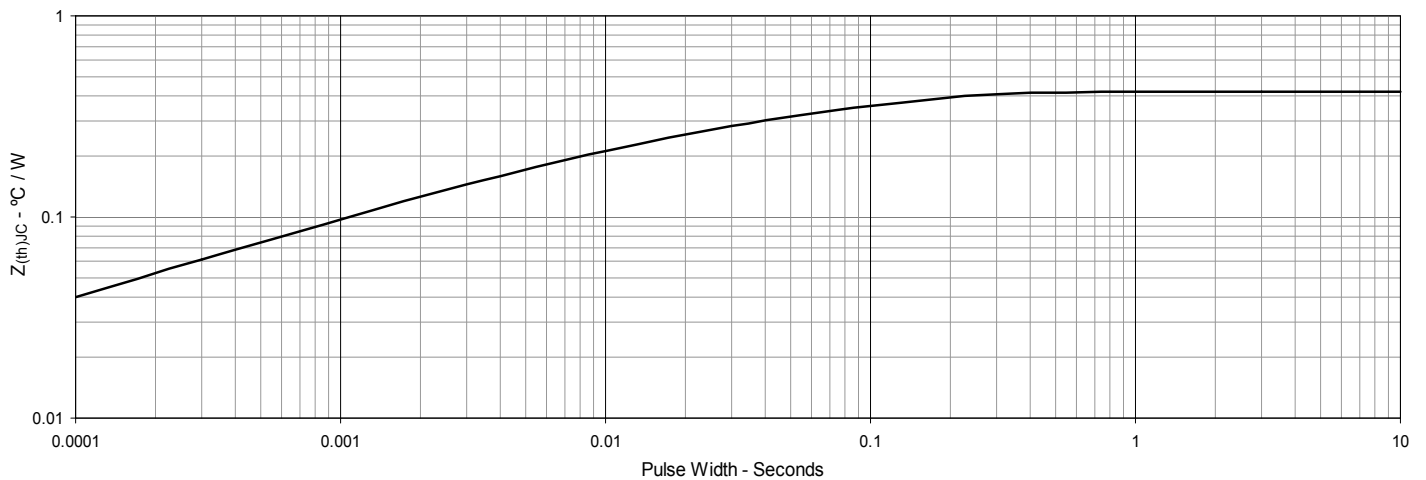
Fig. 12. Inductive Switching Energy Loss vs. Gate Resistance

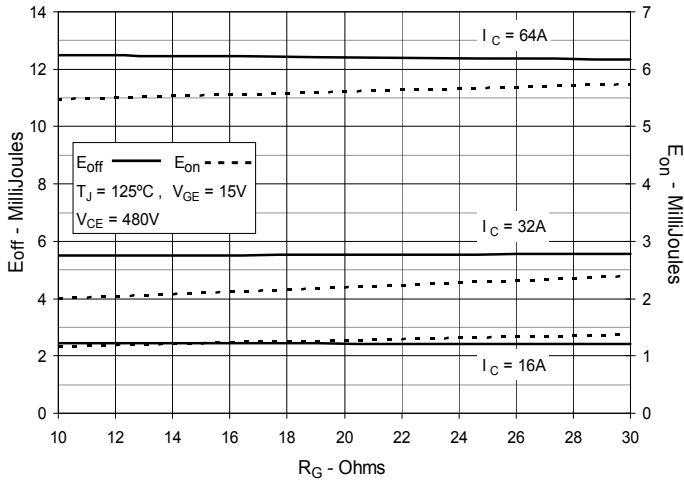

Fig. 13. Inductive Switching Energy Loss vs. Collector Current

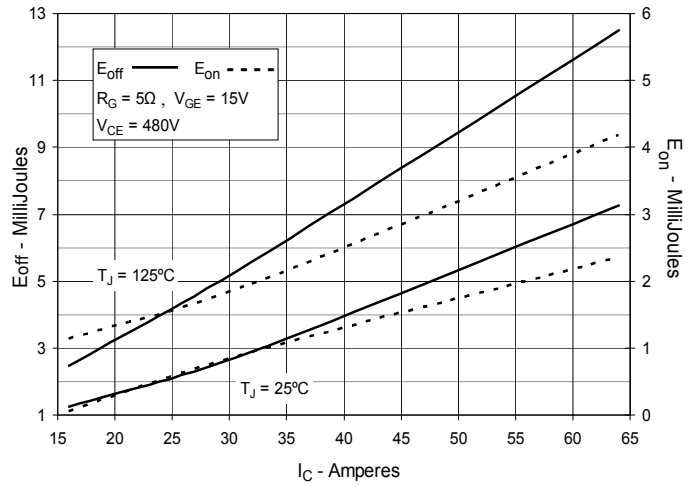

Fig. 14. Inductive Switching Energy Loss vs. Junction Temperature

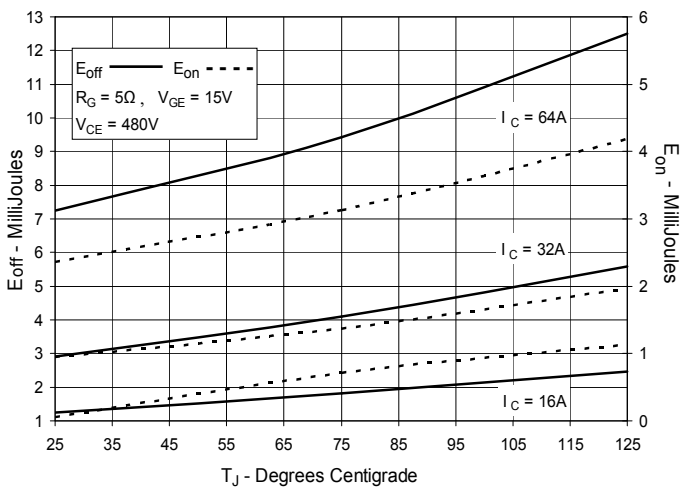

Fig. 15. Inductive Turn-off Switching Times vs. Gate Resistance

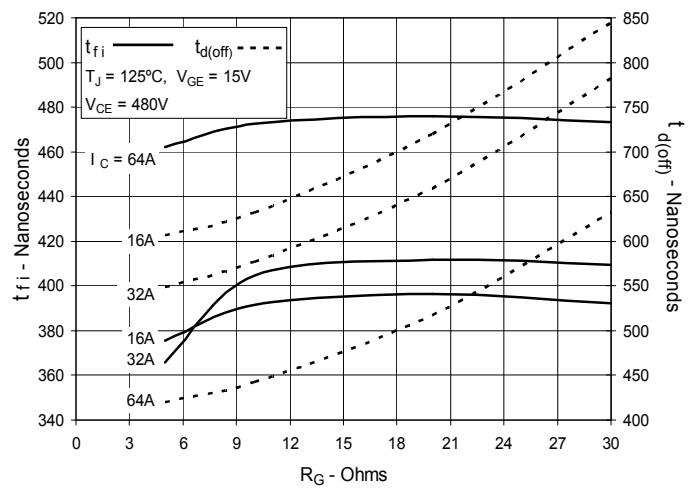

Fig. 16. Inductive Turn-off Switching Times vs. Collector Current

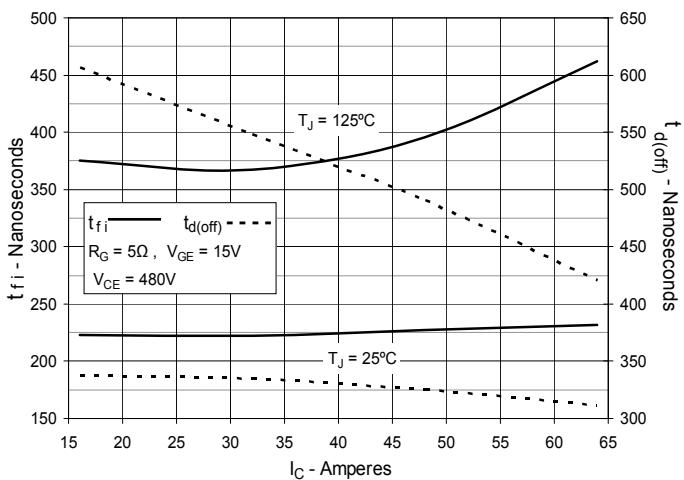

Fig. 17. Inductive Turn-off Switching Times vs. Junction Temperature

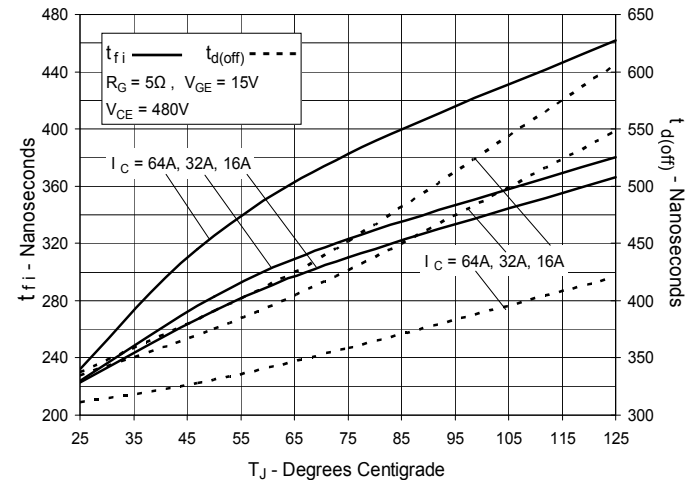
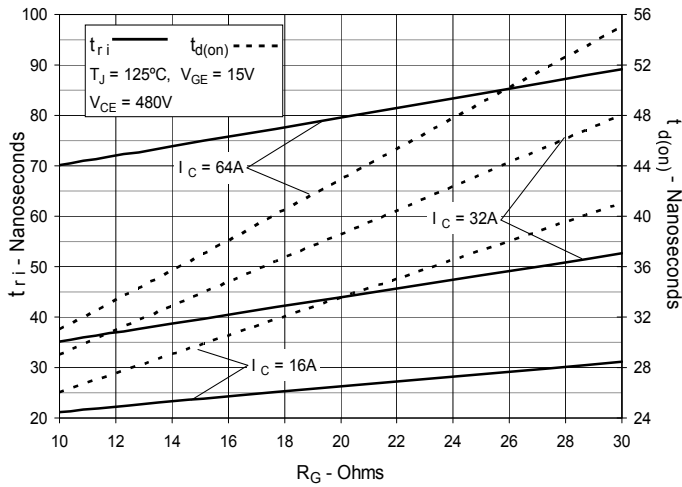
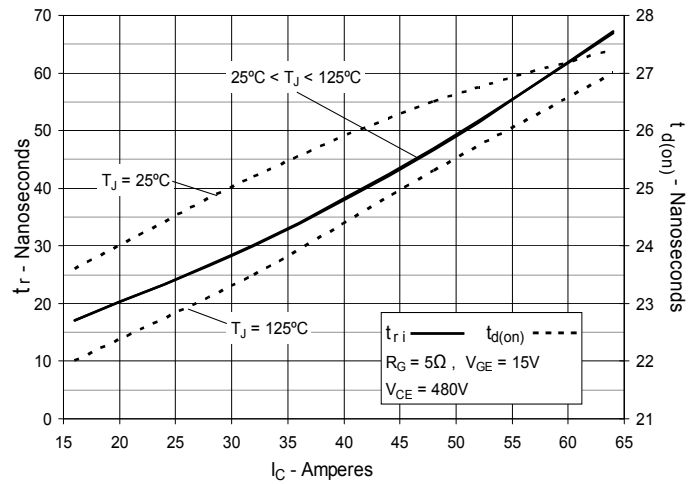
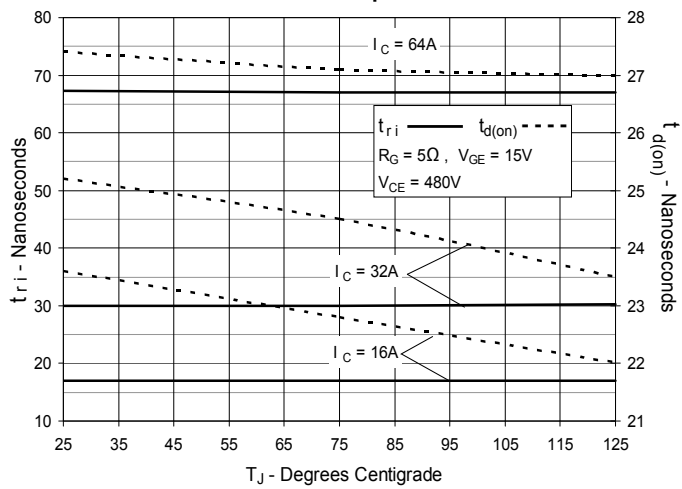

Fig. 18. Inductive Turn-on Switching Times vs. Gate Resistance

Fig. 19. Inductive Turn-on Switching Times vs. Collector Current

Fig. 20. Inductive Turn-on Switching Times vs. Junction Temperature

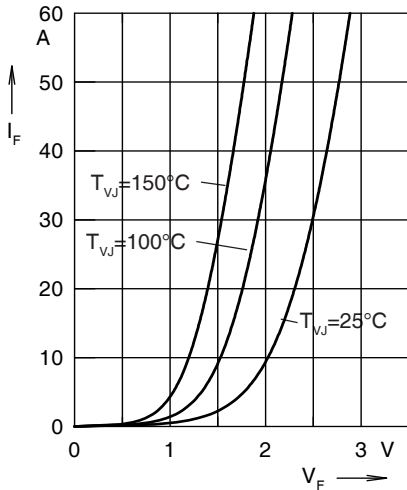

Fig. 21. Forward current I_F versus V_F

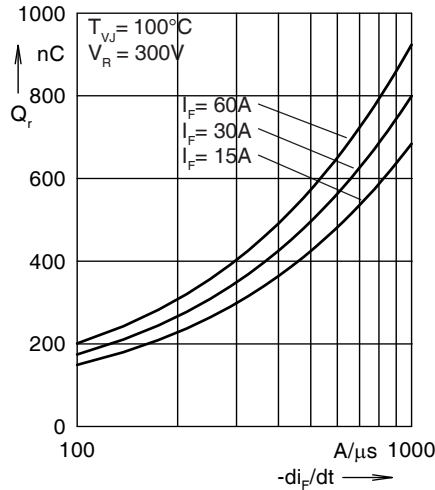

Fig. 22. Reverse recovery charge Q_r versus $-di_F/dt$

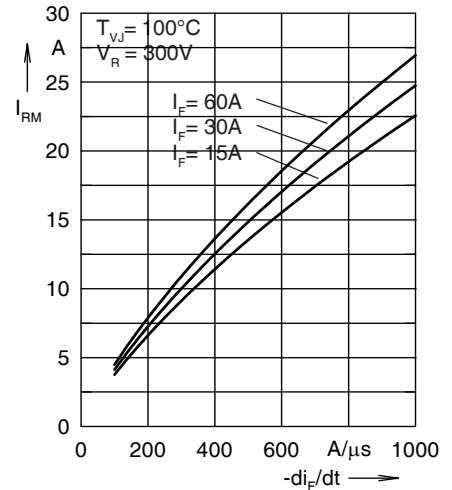

Fig. 23. Peak reverse current I_{RM} versus $-di_F/dt$

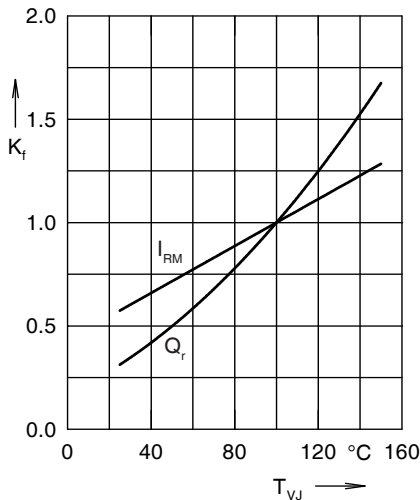

Fig. 24. Dynamic parameters Q_r , I_{RM} versus T_{VJ}

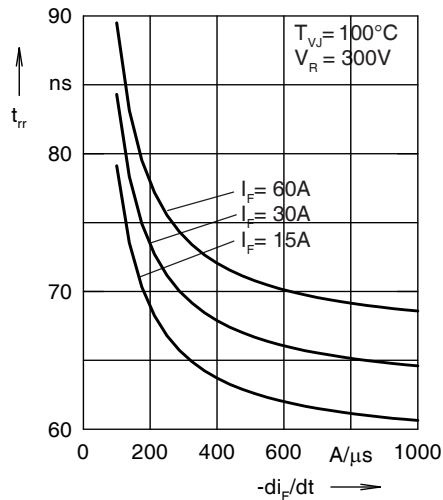

Fig. 25. Recovery time t_{rr} versus $-di_F/dt$

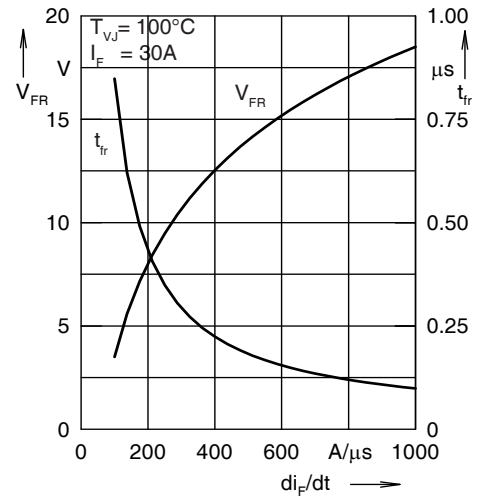

Fig. 26. Peak forward voltage V_{FR} and t_{fr} versus di_F/dt

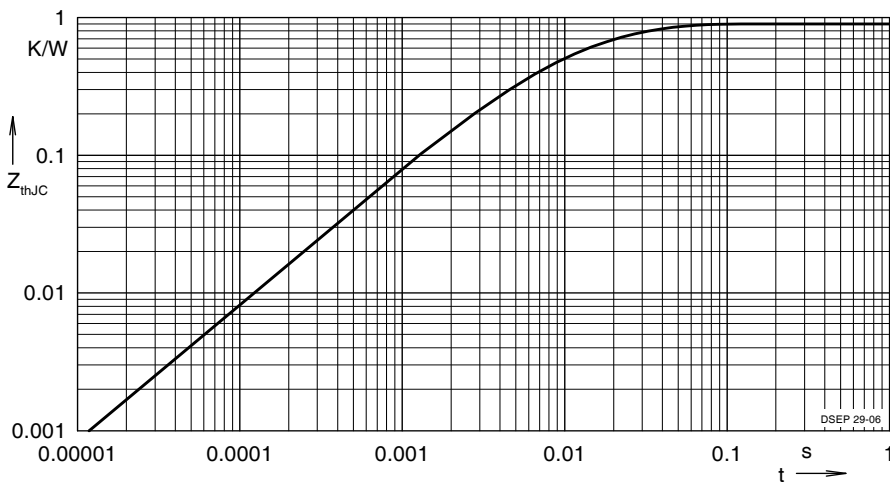

Fig. 27. Transient thermal resistance junction to case

Constants for Z_{thJC} calculation:

i	R_{thi} (K/W)	t_i (s)
1	0.502	0.0052
2	0.193	0.0003
3	0.205	0.0162



Disclaimer Notice - Information furnished is believed to be accurate and reliable. However, users should independently evaluate the suitability of and test each product selected for their own applications. Littelfuse products are not designed for, and may not be used in, all applications. Read complete Disclaimer Notice at www.littelfuse.com/disclaimer-electronics.